

ASSEMBLY INSTRUCTIONS

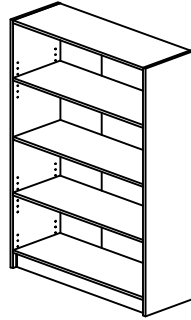

IMPORTANT PLEASE READ BEFORE YOU CONTINUE FURTHER

WARNING AND INSTRUCTIONS

- PLEASE KEEP THE ORIGINAL PACKAGING UNTIL THE ITEM IS FULLY ASSEMBLED AND IN PLACE. IN THE UNLIKELY EVENT THAT YOU NEED TO RETURN YOUR PRODUCT, IT MUST BE RETURNED IN ITS ORIGINAL PACKAGING TO AVOID FURTHER DAMAGE. FAILURE TO COMPLY TO THESE PROCEDURES, NO RETURN'S WILL BE ACCEPTED.
- IMPORTANT: RETAIN THESE INSTRUCTIONS FOR FUTURE REFERENCE.
- DUE TO THE SIZE OF THIS PRODUCT WE RECOMMEND THAT IT IS ASSEMBLED IN THE ROOM INTENDED FOR USE.
- WHEN YOU ARE READY TO START, MAKE SURE THAT YOU HAVE THE RIGHT TOOLS, PLENTY OF SPACE AND A CLEAN, DRY AREA FOR ASSEMBLY.
- UNWRAP ALL PACKAGING MATERIALS AND PLACE THE COMPONENTS ON TOP OF THE CARTON BOX OR ON A CLEAN FLOOR TO PREVENT IT FROM SCRATCHING.
- CHECK THE PACK AND MAKE SURE YOU HAVE ALL THE PARTS LISTED.
- ENSURE THAT THIS PRODUCT IS FULLY ASSEMBLED AS ILLUSTRATED BEFORE USE.
- TOOLS NOT INCLUDED.
- CHECK ALL SCREWS OR BOLTS ARE TIGHTENED AND INSPECT REGULARLY.
- THIS PRODUCT SHOULD ONLY BE USED ON FIRM LEVEL GROUND.
- KEEP SMALL PART OUT OF REACH OF CHILDREN.
- MAKE SURE THE LEGS REMAIN IN CONTACT WITH THE GROUND.
- DO NOT USE POWER TOOLS TO CONSTRUCT THIS PRODUCT.
- DO NOT TIGHTENED SCREWS UNTIL FULLY ASSEMBLED.
- DO NOT OVER TIGHTENED SCREWS OR BOLTS.
- DO NOT USE THIS PRODUCT IF PARTS ARE MISSING, DAMAGE OR WORN.
- DO NOT SIT AND STAND ON THE PRODUCT.
- TO CLEAN WIPE WITH A SPONGE AND WARM SOAPY WATER. DO NOT USE SOLVENT BASED CLEANERS OR DETERGENTS AS THEY CAN BLEACH OR DAMAGE THE PRODUCT.
- NEVER USE SCOURERS, ABRASIVES OR CHEMICAL CLEANERS.

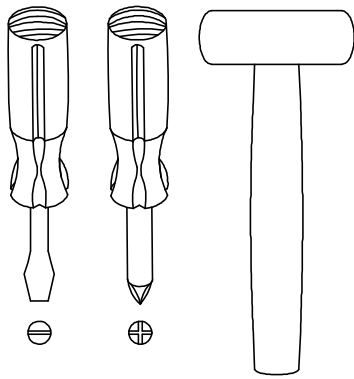

(Tools not provided)

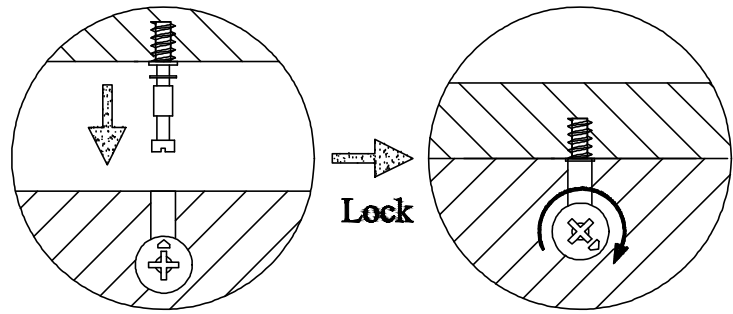

Use a flat blade screwdriver to tighten the cam nuts. A quarter turn clockwise is all that is needed.

This is how a cam nut works.....

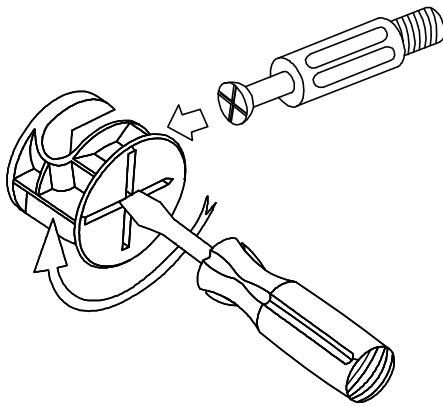

The head of the cam bolt goes into the open mouth of the cam nut. You then turn the cam nut so it tightens over the bolt.

TWO PERSONS REQUIRED TO ASSEMBLE THIS PRODUCT



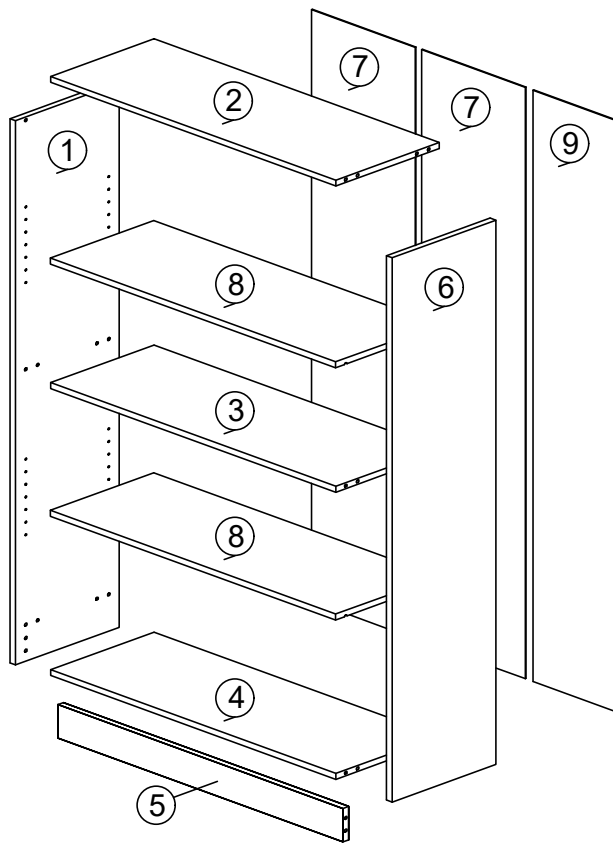





1. Please check that you have all the parts listed before you start assembling. If you do find that something is missing, do not continue assembly. Please contact your supplier immediately.
2. Lay out all of the components on a soft surface as if you were preparing to do a jigsaw puzzle.
3. Separate and identify each component from the hardware pack and rest each one in its proper location before fastening.



PARTS LIST

NO.	PARTS					QTY
1	1500	X	296	X	15	1 PCS
2	770	X	295	X	15	1 PCS
3	770	X	295	X	15	1 PCS
4	770	X	295	X	15	1 PCS
5	770	X	85	X	15	1 PCS
6	1500	X	296	X	15	1 PCS
7	1413	X	278	X	2.5	2 PCS
8	770	X	295	X	15	2 PCS
9	1413	X	238	X	2.5	1 PCS

HARDWARE LIST

NO.	DESCRIPTION		QTY
A		WOOD DOWEL M8x25MM	16
B		NAIL 5/8	28
C		L KEY	1
D		CAM NUT	12
E		CAM BOLT	12
F		CAM CAP	8
G		SHELF SUPPORT	8
H		PVC NAIL WITH PIN 5/8	4

THE USE OF POWER TOOLS TO ASSEMBLE THIS PRODUCT WILL INVALIDATE ANY CLAIM AND MAY DAMAGE THIS PRODUCT MAKING IT UNSAFE.



STEP 1

A	 WOOD DOWEL M8x25MM	16
---	--	----

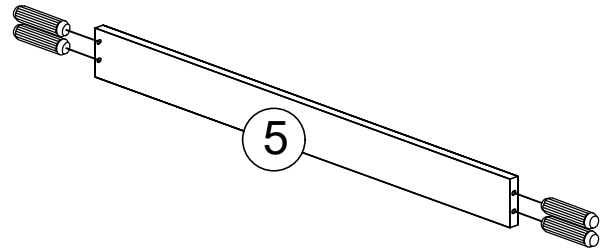
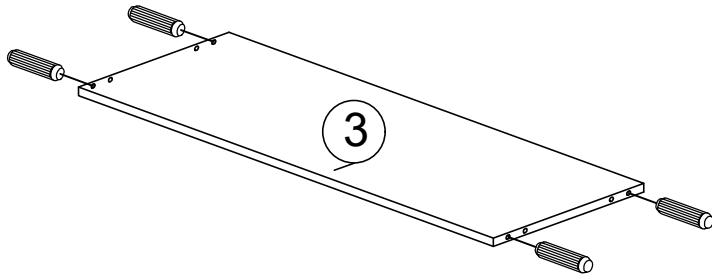
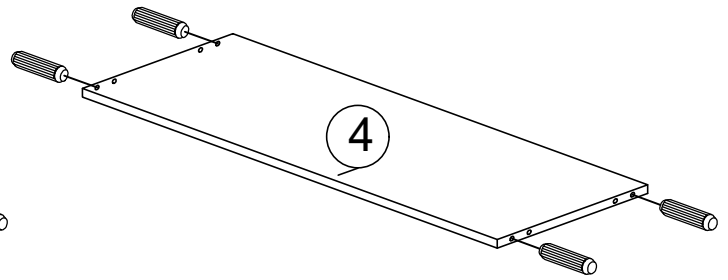
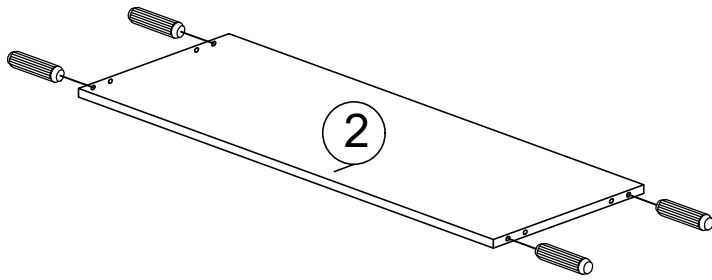

STEP 2

E	 CAM BOLT	12
---	--	----

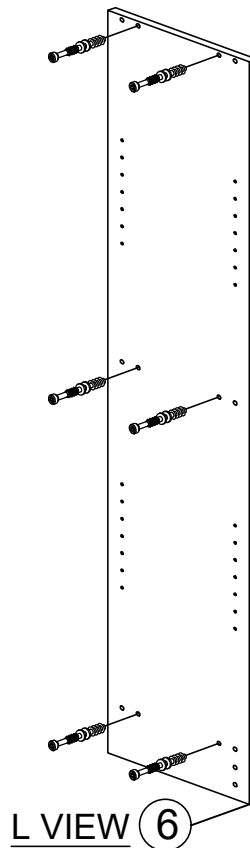
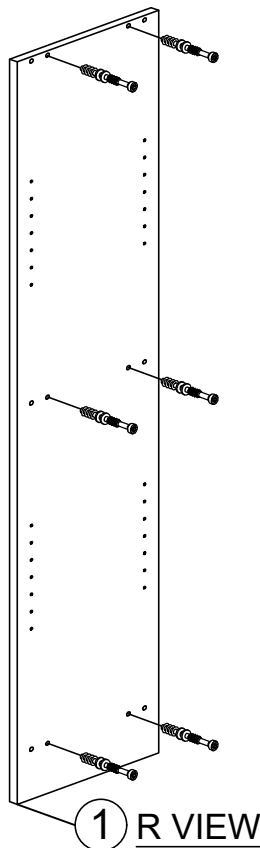

THE USE OF POWER TOOLS TO ASSEMBLE THIS PRODUCT WILL INVALIDATE ANY CLAIM AND MAY DAMAGE THIS PRODUCT MAKING IT UNSAFE.



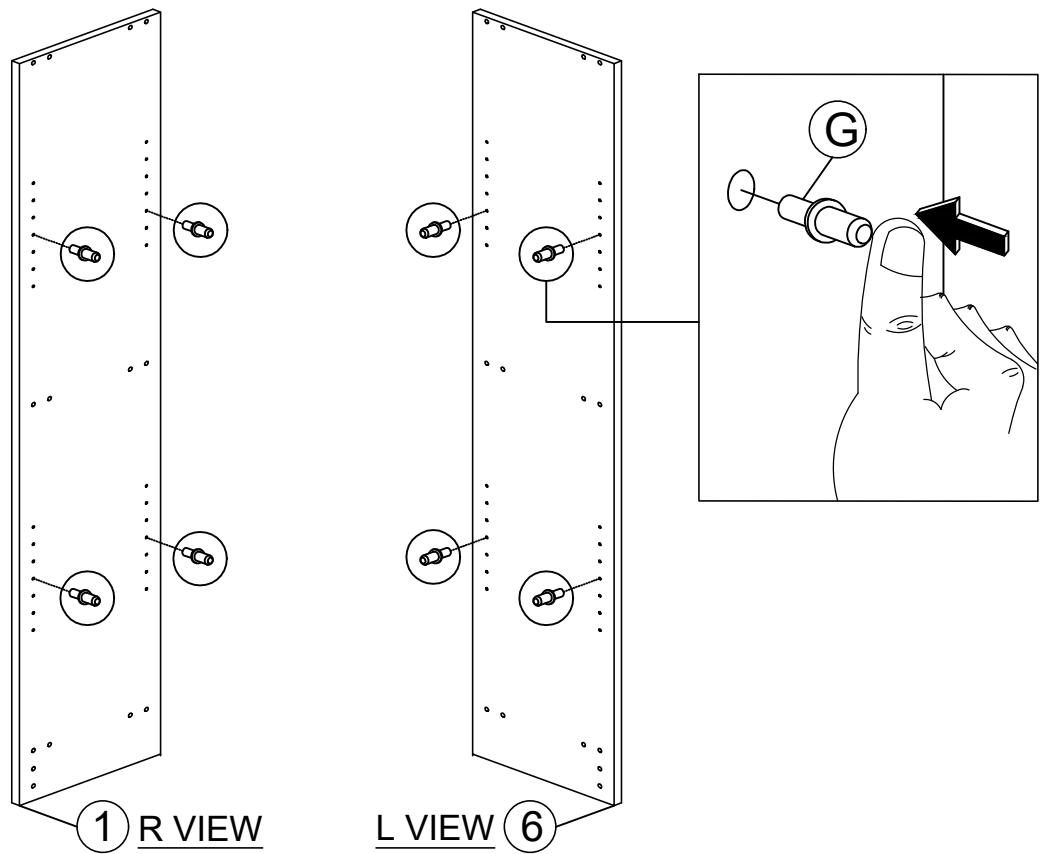

STEP 3

G	 SHELF SUPPORT	8
---	---	---



STEP 4

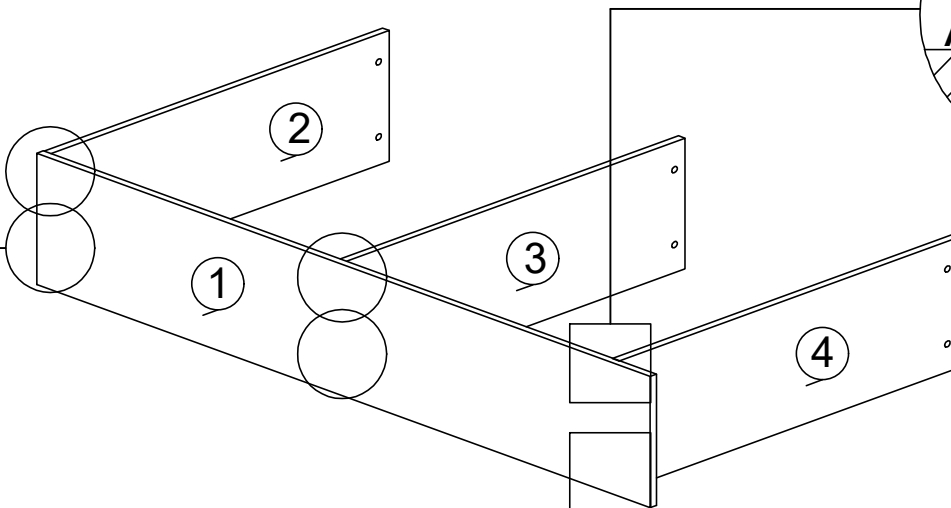
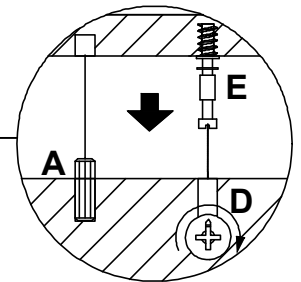
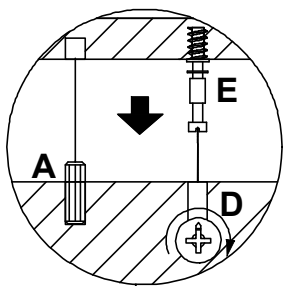
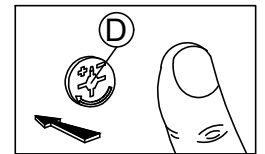
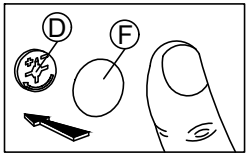

C	 L KEY	1
D	 CAM NUT	6
F	 CAM CAP	4



THE USE OF POWER TOOLS TO ASSEMBLE THIS PRODUCT WILL INVALIDATE ANY CLAIM AND MAY DAMAGE THIS PRODUCT MAKING IT UNSAFE.



STEP 5

C		L KEY	1
D		CAM NUT	6
F		CAM CAP	4

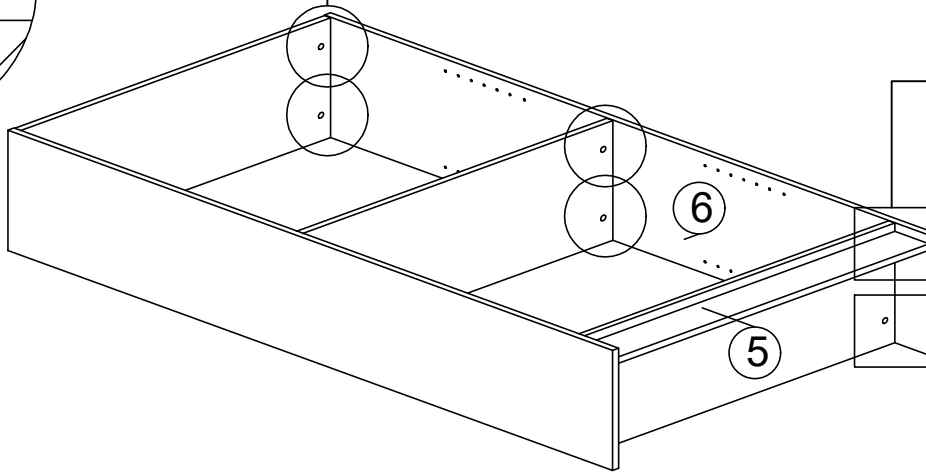
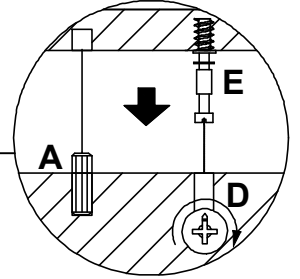
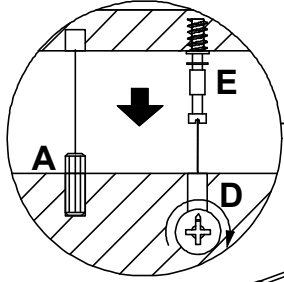
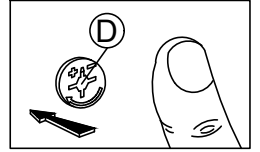
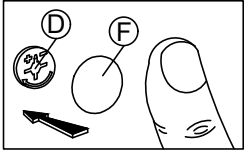

STEP 6

H		PVC NAIL WITH PIN 5/8	4
---	---	-----------------------	---

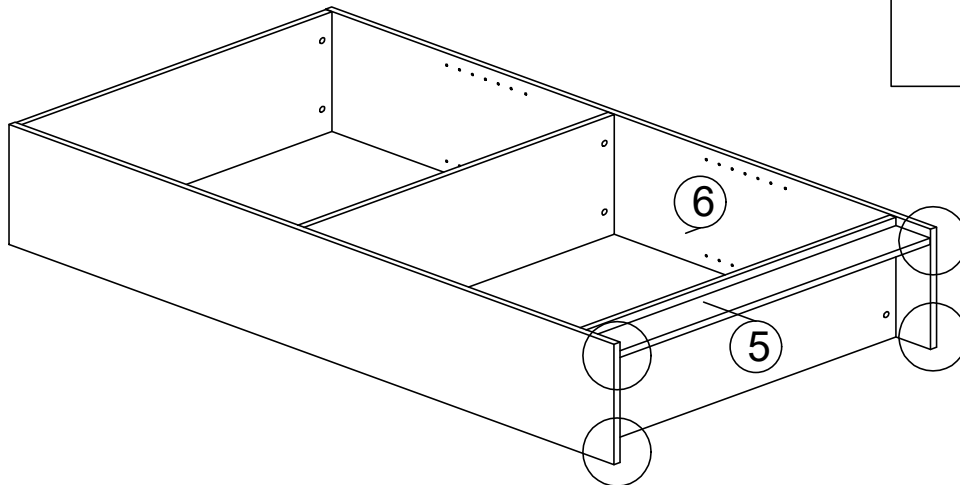
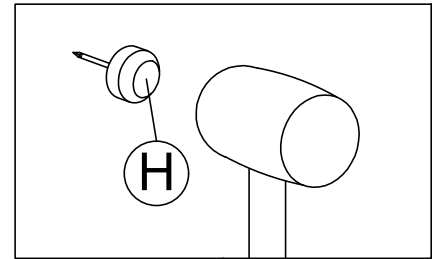

THE USE OF POWER TOOLS TO ASSEMBLE THIS PRODUCT WILL INVALIDATE ANY CLAIM AND MAY DAMAGE THIS PRODUCT MAKING IT UNSAFE.



STEP 7

B	 NAIL 5/8	28
---	--	----

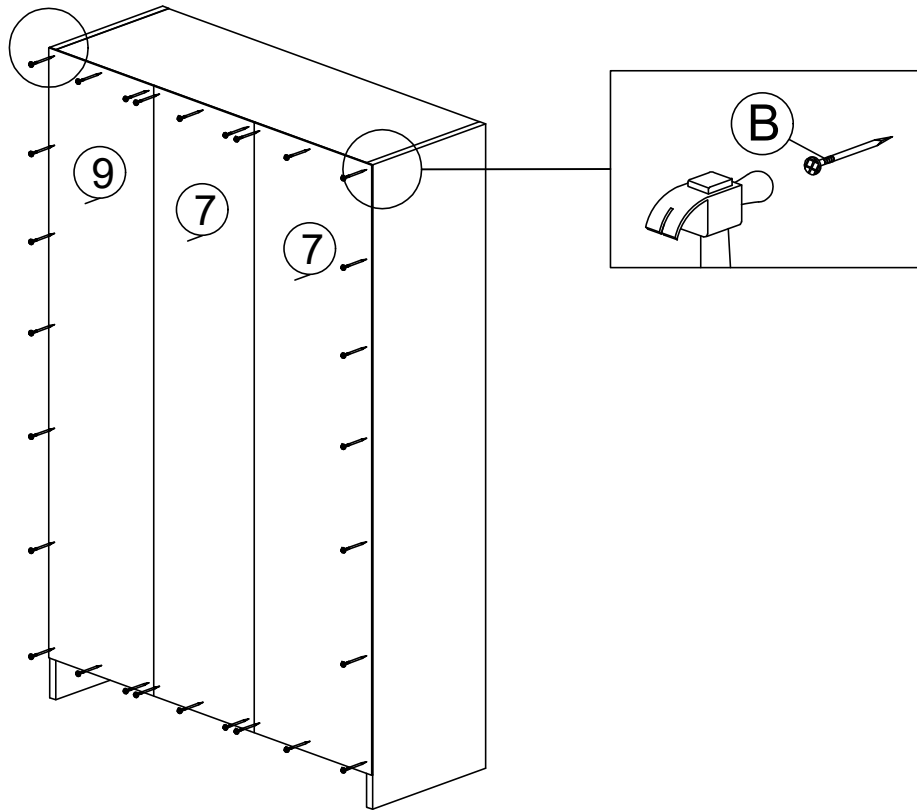

STEP 8

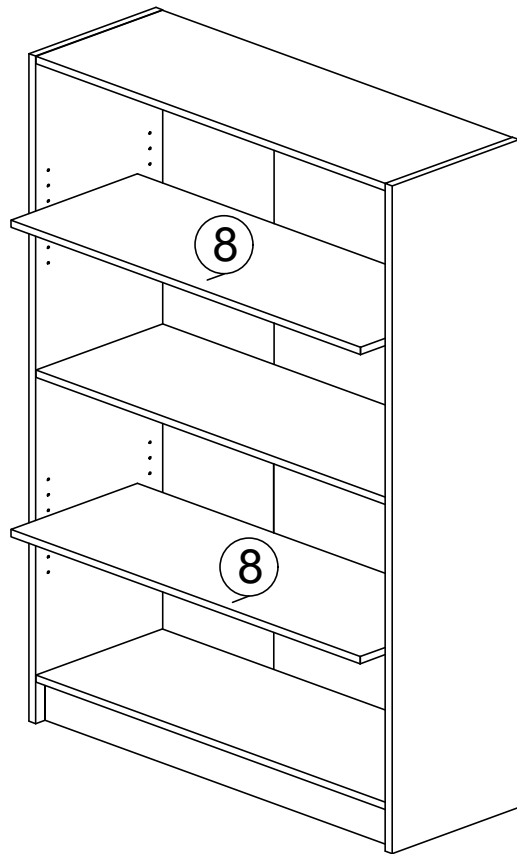

THE USE OF POWER TOOLS TO ASSEMBLE THIS PRODUCT WILL INVALIDATE ANY CLAIM AND MAY DAMAGE THIS PRODUCT MAKING IT UNSAFE.



COMPLETED

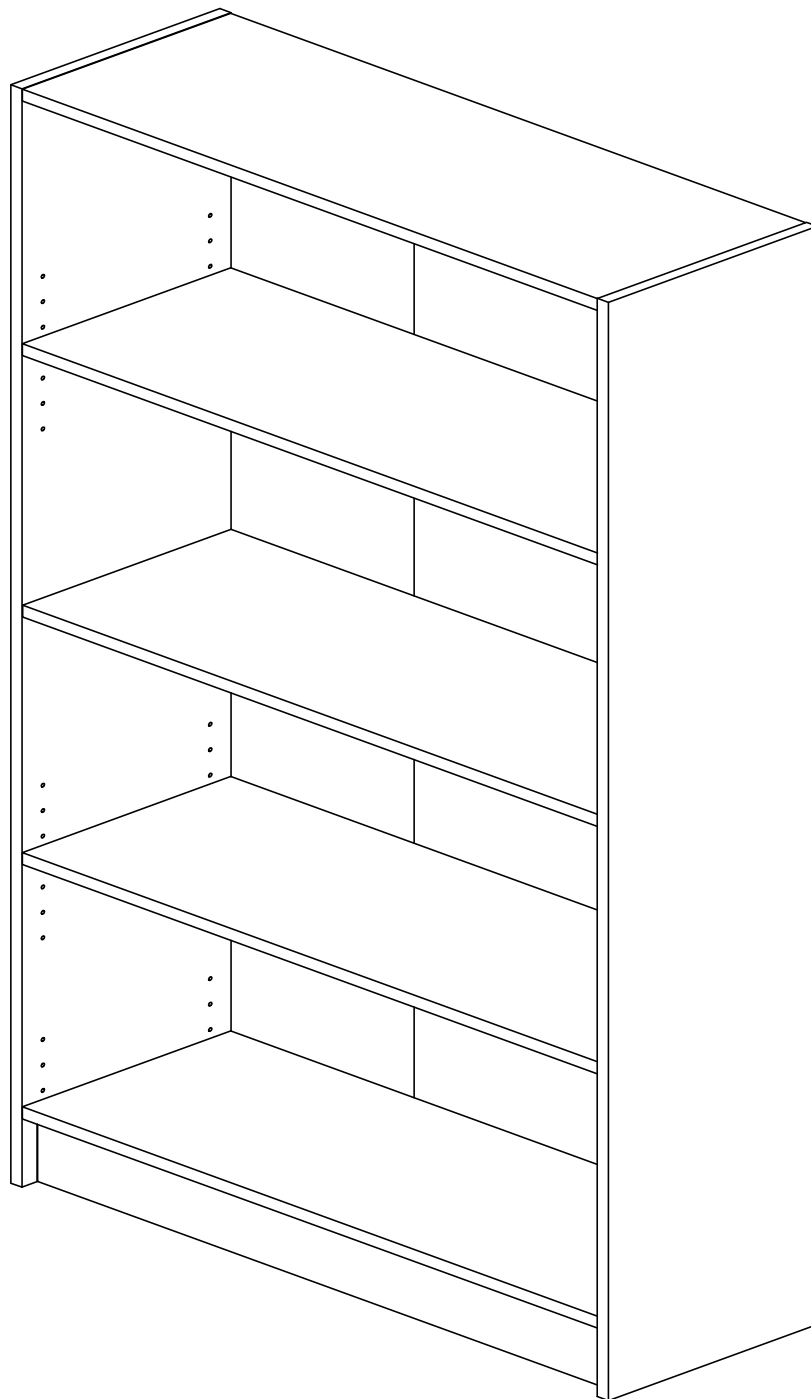

THE USE OF POWER TOOLS TO ASSEMBLE THIS PRODUCT WILL INVALIDATE ANY CLAIM AND MAY DAMAGE THIS PRODUCT MAKING IT UNSAFE.

