

MANUAL DE MONTAGEM

ASSEMBLY INSTRUCTIONS

INSTRUCCIONES DE MONTAJE



OBSERVAÇÕES IMPORTANTES

IMPORTANT REMARKS

OBSERVACIONES IMPORTANTES



Nunca escale ou se apoie sobre o móvel. Você pode sofrer graves acidentes.

Never climb or lean on the furniture. You may suffer serious accidents.

Nunca escale o apoye sobre el mobiliario. Usted puede sufrir accidentes graves.

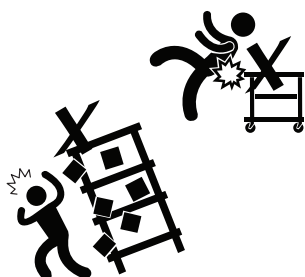

Utilize a embalagem para forrar a área de montagem e separar todas as peças.

Use the packaging to cover the assembly area and separate all parts.

Utilice el embalaje para cubrir la area de montaje y separe las piezas.

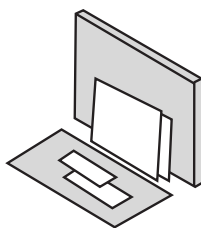

Observe os números impressos nas bordas para identificar as peças.

Identify the parts by observing the number printed on their edges.

Identifique las piezas observando el numero impreso en sus bordes.

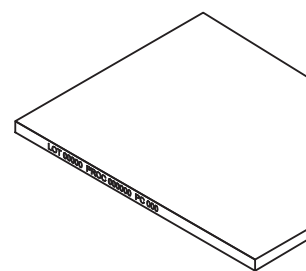

LIMPEZA E CONSERVAÇÃO

CARE INSTRUCTIONS

LIMPIEZA Y CONSERVACIÓN



Limpe com um pano limpo e umedecido em água e sabão neutro. Não utilizar produtos químicos e abrasivos.

Wipe clean using a damp cloth and a mild cleaner. Do not use abrasive and chemical products.

Limpie con un paño limpio humedecido con agua y jabón neutro. No utilice productos químicos y abrasivos



MOVIMENTAÇÃO

HANDLING

MOVIMENTO

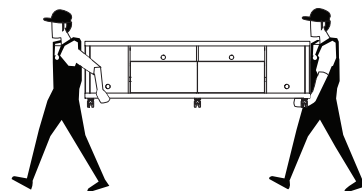

Movimente o móvel com cuidado, sem arrastar. Peça ajuda a outra pessoa para fazê-lo.

Move the piece carefully, don't drag it. Ask for someone else's help to do so.

Mover la unidad con cuidado, sin arrastrar. Pedir ayuda a otra persona para moverlo.

ACESSÓRIOS

HARDWARE

HERRAJES



Identifique e separe os acessórios utilizados.
Em cada embalagem, uma etiqueta identifica as peças e onde utilizá-las.

Identify and separate the hardware used in the assembly. There's a label on each package identifying the parts and where to use them.

Identifique y separe los accesorios utilizados en el montaje. Observe la etiqueta en cada paquete para saber donde montar.

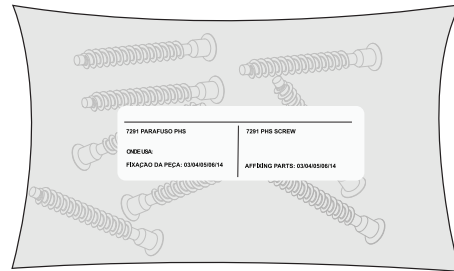

COD. 8471

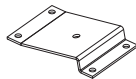

A

COD. 8056

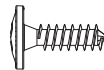

B

DESCRIÇÃO

DESCRIPTION

DESCRIPCIÓN

PEÇA PART PIEZA	QUANTIDADE QUANTITY CANTIDAD	DESCRIÇÃO	DESCRIPTION	DESCRIPCIÓN
01	01	TAMPO	TABLE TOP	CUBIERTA
50	04	PÉ	LEG	PATAS
52	04	PÉ	LEG	PATAS
56	04	PÉ	LEG	PATAS



20Kg =44Lb

L:800mm A:280mm P:800mm
W:31,50 inches H:11,02 inches D:31,50inches

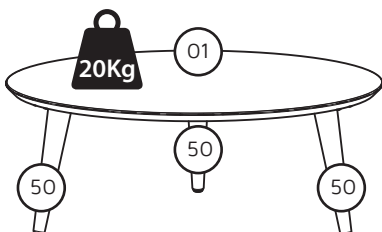

L:593mm A:356mm P:593mm
W:23,34 inches H:14,01 inches D:23,34 inches

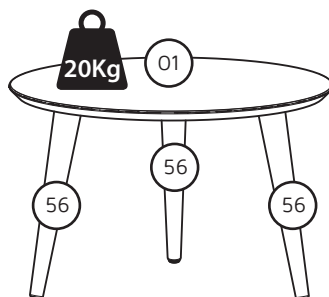

L:443mm A:485mm P:443mm
W:17,44 inches H:19,09 inches D:17,44 inches

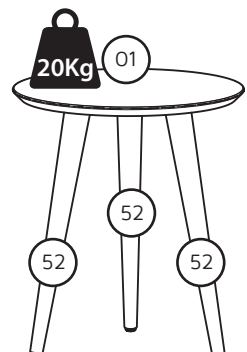

01

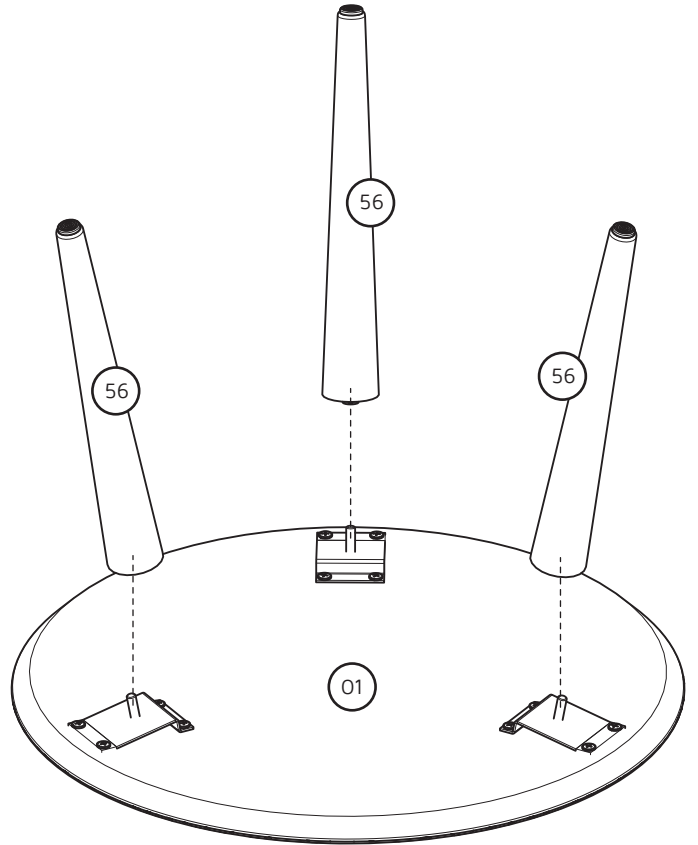
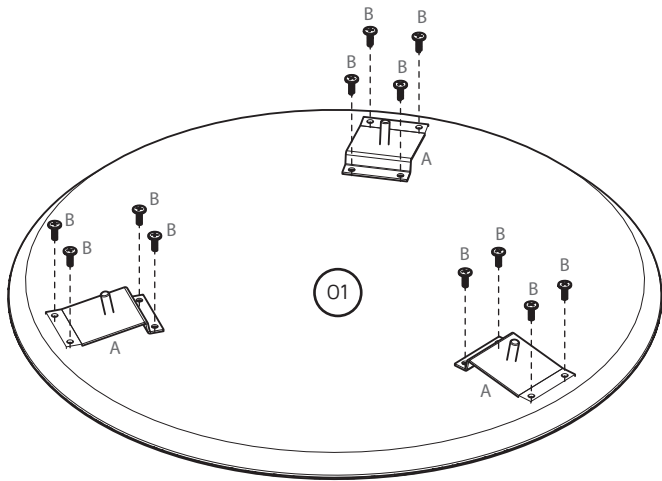

02

