

# Installation manual.

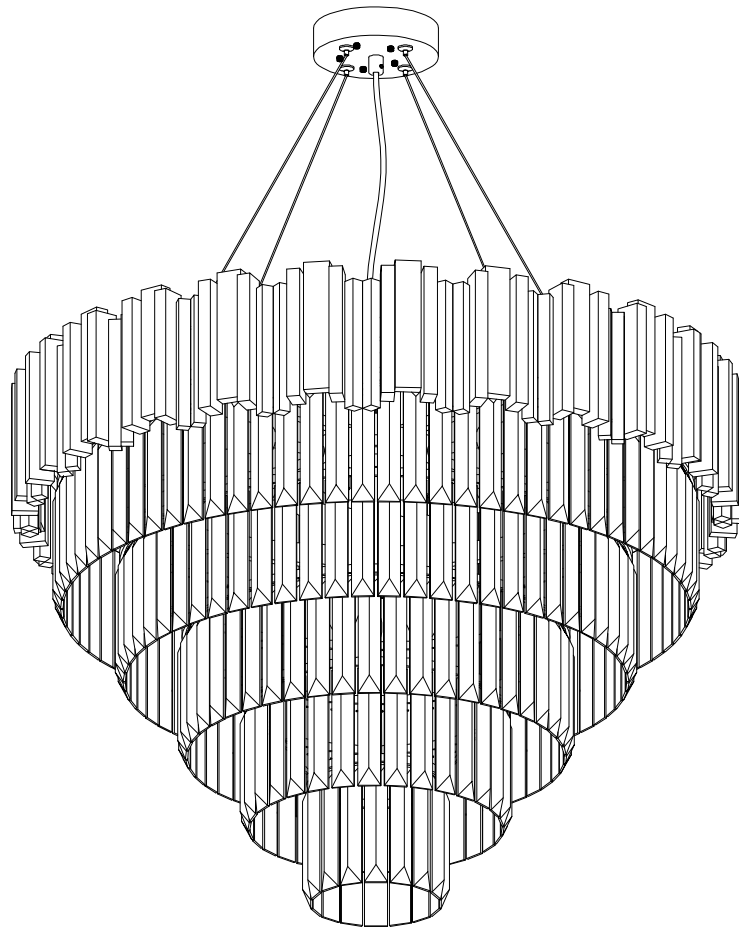

## Chandelier Installation and Safety Standards

**The installation of a chandelier is a crucial step in ensuring its safety. Chandelier safety standards dictate the process of installation, including the tools and equipment that can be used, the methods of securing the chandelier, and the location of the chandelier.**

**Securing the chandelier is a crucial step in the installation process. Chandelier safety standards dictate that the chandelier must be securely attached to a suitable support, such as a ceiling joist, to prevent it from falling. This includes ensuring that the support is strong enough to bear the weight of the chandelier, and that the chandelier is properly balanced to prevent it from tipping or swaying.**

**Furthermore, the chandelier must be secured using suitable hardware, such as screws or bolts, that are strong enough to bear its weight. The hardware must be properly installed and tightened to ensure that the chandelier is securely attached. Regular inspections of the hardware are also necessary to detect and repair any damage or wear promptly.**

# Packaging diagram.

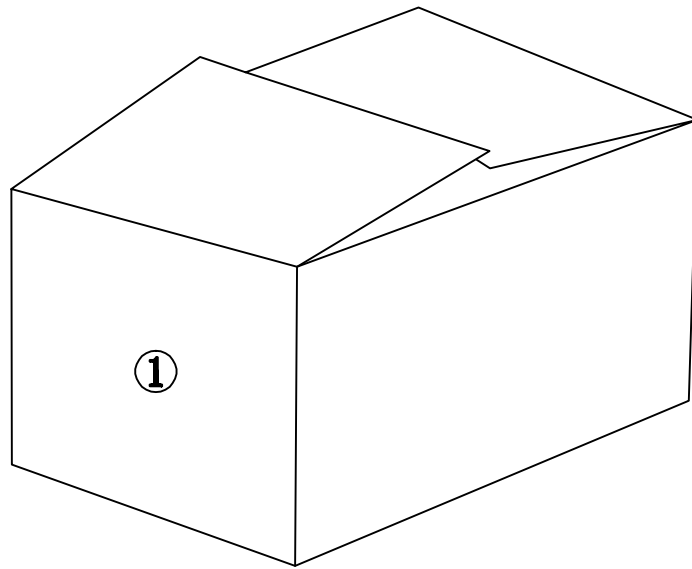

①

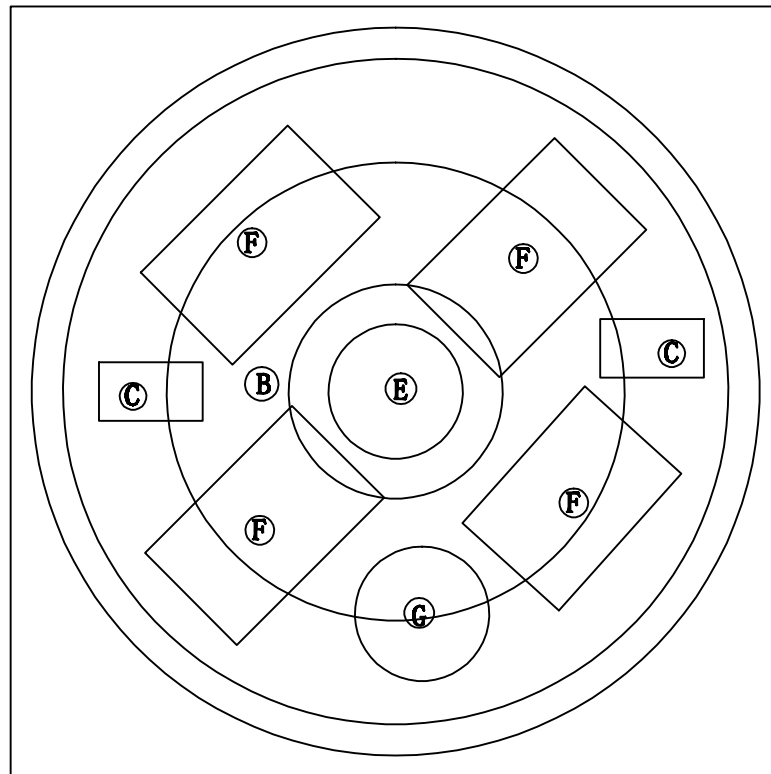

## Internal packaging list:

1. Second layer lamp frame main body + crystal lampshade + suspension rod +hanging chain + ceiling plate + accessory pack + light sources

## Before assembly:

- ★ Please read all instruction steps carefully.
- ★ Keep the manual for future reference.
- ★ Separate and list all parts and hardware.
- ★ Read each step carefully and follow the correct installation order.
- ★ To avoid losing parts during assembly, we recommend not moving the fixture until the assembly is complete. Always keep the product on a flat, sturdy, and stable surface.
- ★ Keep all small parts and packaging materials of this product away from babies and children, as they may cause serious injury.

### ★ Product specifications:

Lamp holder: E12\*21    Wattage: 3W (each)    Color temperature: 2700K

## Installation instruction

Please note:

Please check the parts list,  
if the

parts are missing during your  
actual installation, please contact us,  
we will help you in time!

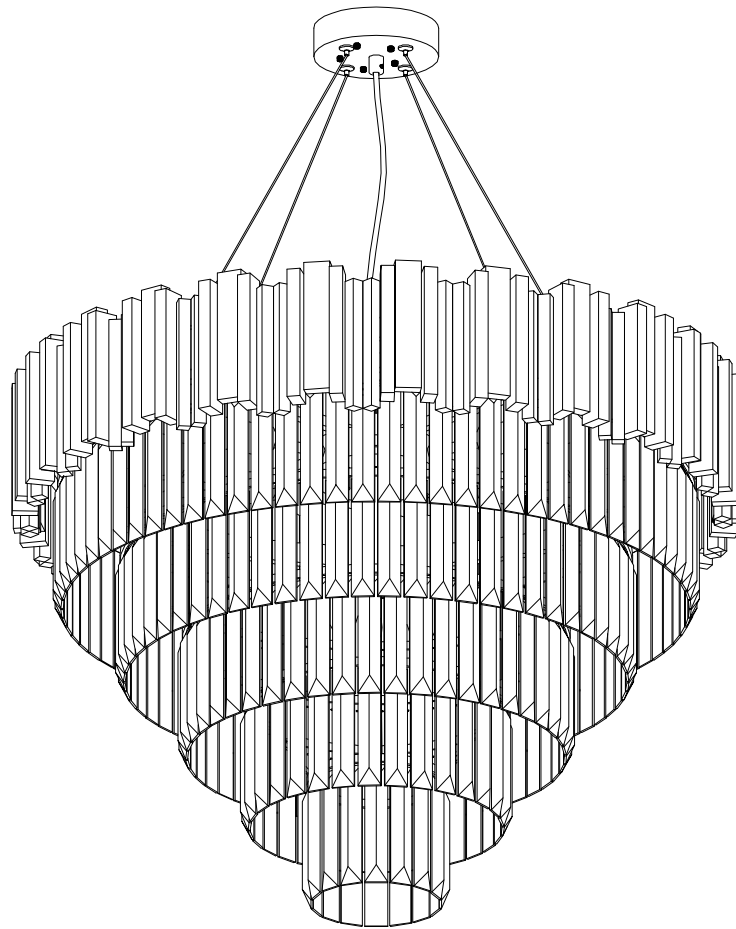

Steps:

1. Take out the laPp body and check the firmness of the lamp body;

# FINISHED PRODUCTS

install effect A(Flat ceiling)

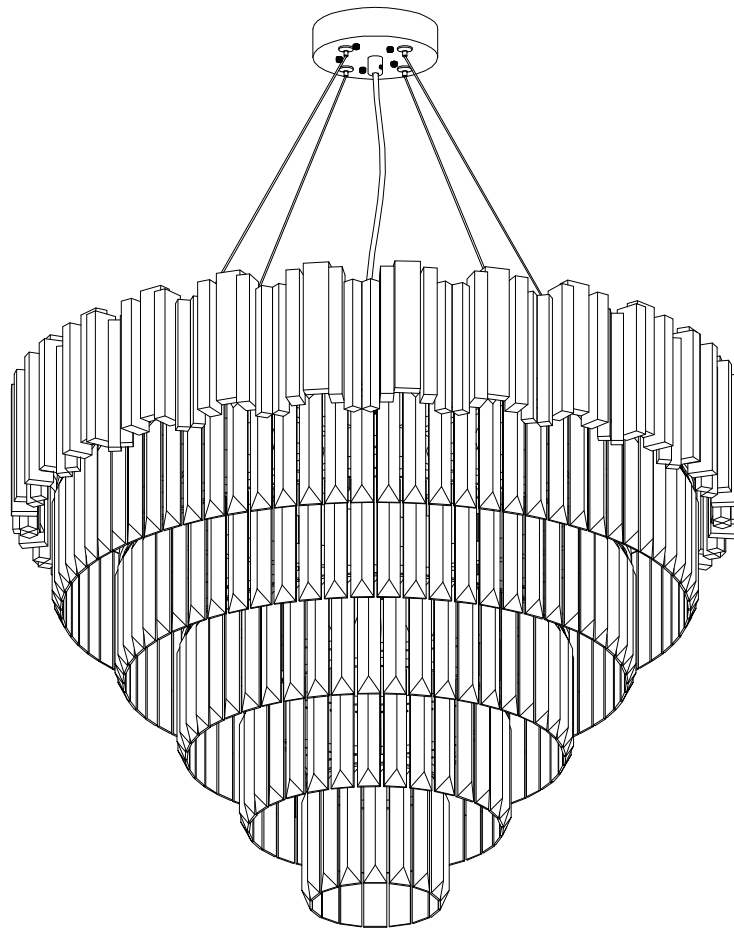







**NOTES:** Due to the handmade nature of the product, slight variations in dimensions may occur.

**Maintenance:**

To ensure safe and efficient use of this product, please clean the lamp regularly (once a month). Before cleaning, turn off the power and wait for the lamp to cool to room temperature. Then use a soft cloth dipped in water and wrung dry to wipe it clean.

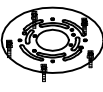
# Accessory list.

-   
2PCS
-   
4PCS
-   
4PCS
-   
4PCS
-   
x1
-   
5PCS

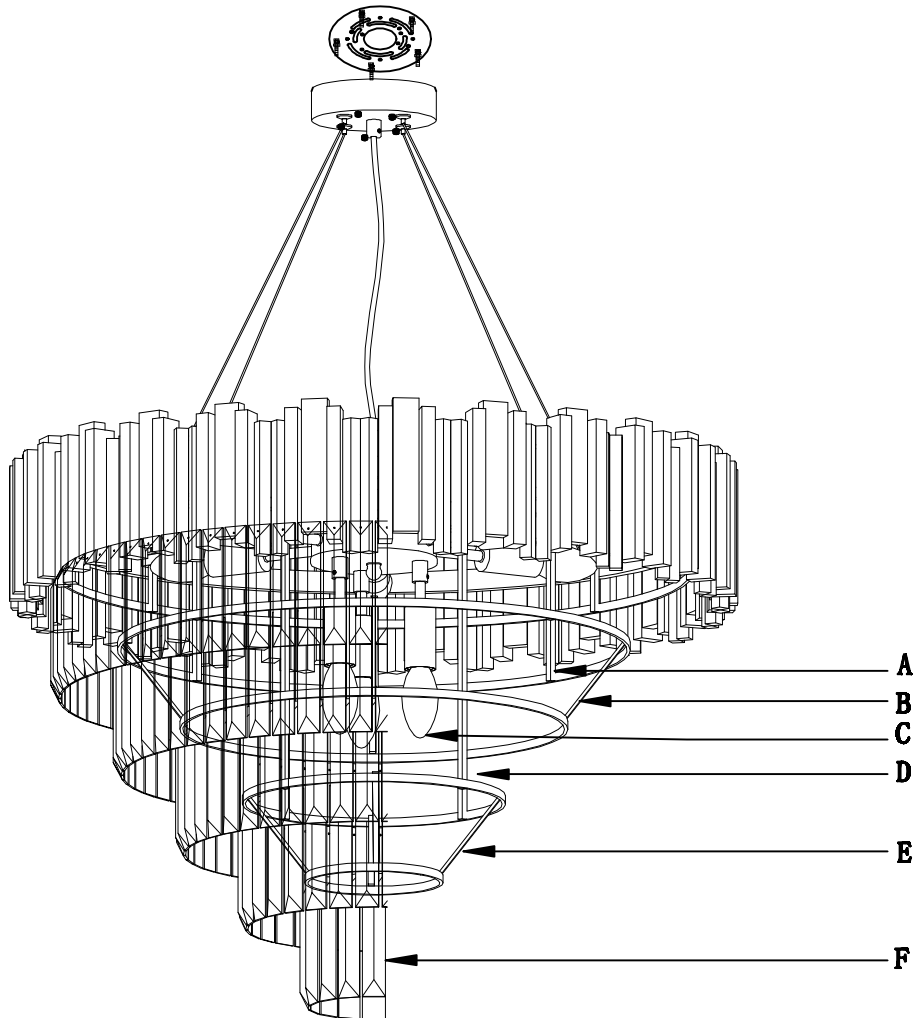

 A. 6\*6\*120—4 pieces

 B. D490 — 1 pieces

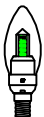
 C. Light sources - 9 pieces

 D. 6\*6\*270— 4 pieces

 E. D250 — 1 pieces

 F. 22\*120— 228 pieces

 G. D120-- 1 pieces

# FINISHED PRODUCTS

install effect A(angle ceiling)

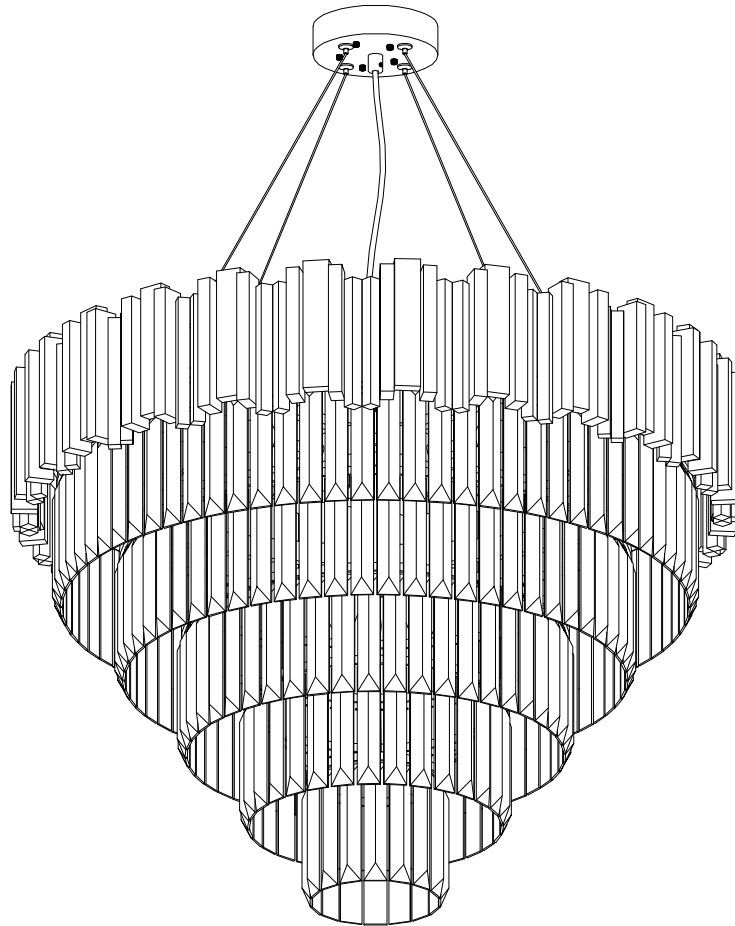

**NOTES:** Due to the handmade nature of the product, slight variations in dimensions may occur.

## **Cautions.**

- 1. This lamp can only be used indoors;**
- 2. TURN OFF THE POWER BEFORE THE INSTALLATION IS FINISHED.**

# Installation instruction

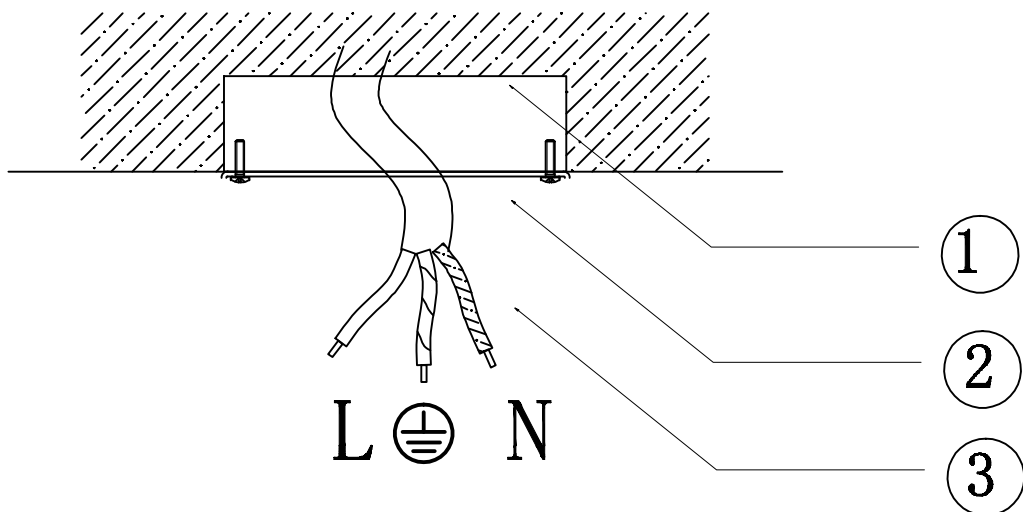
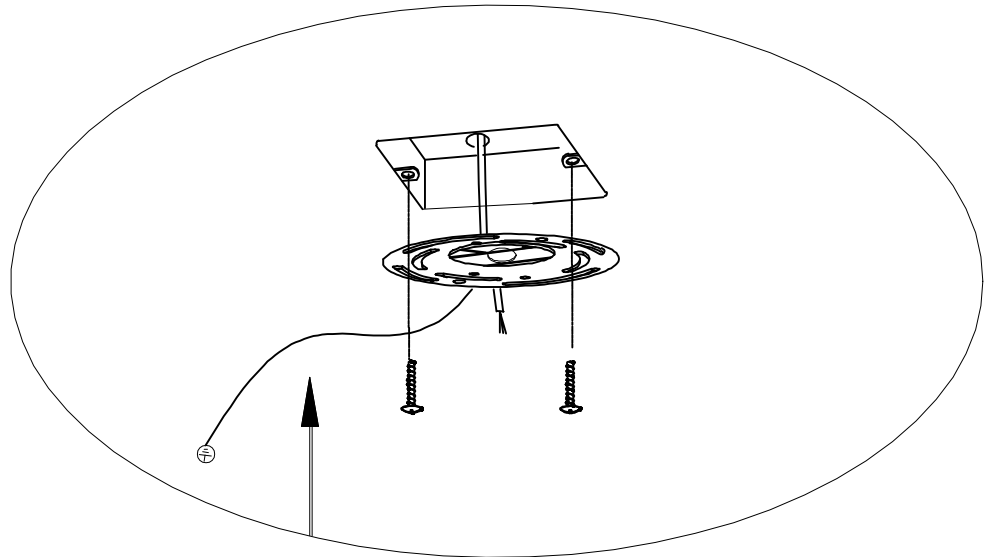

Steps:

1. Remove the crossbar from the preassembled mounting base;
2. Lock the crossbar on the junction box with the screw.

## ① Lamp body assembly:

- (1) Locate Lamp Body B from the sorting list.
- (2) Take out the rod tubes and connect them sequentially with Connector F to the desired length.
- (3) Thread the power cable from the lamp body through the tubes, and pass the chain into the ceiling plate, securing the lamp body and tubes with the lock clip.

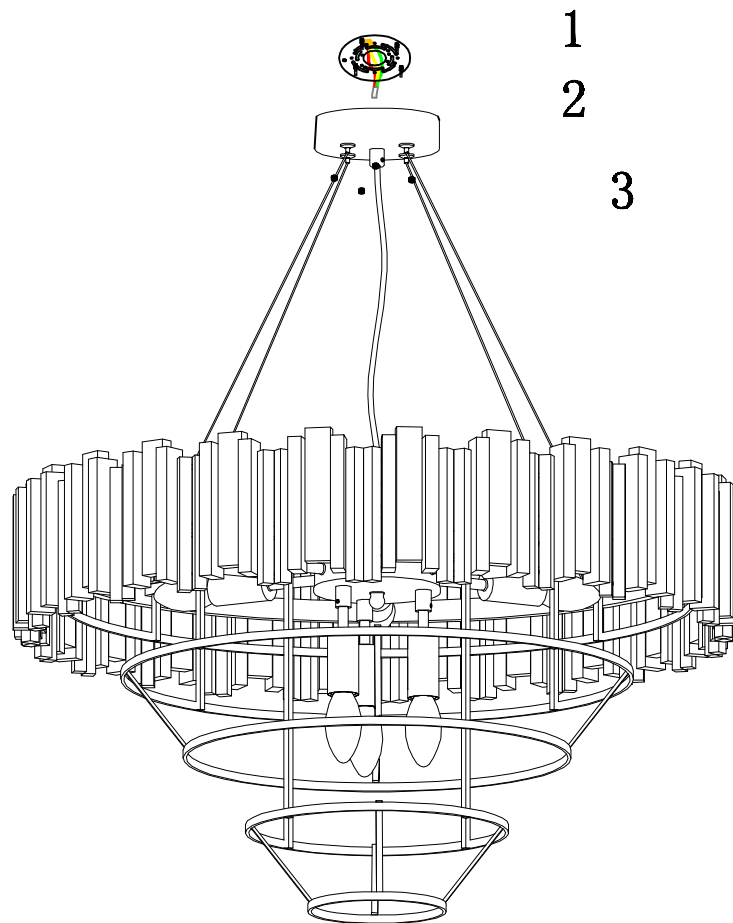

**★ If your product has any issues upon receipt, please:**

1. Provide your order number.
2. Attach a photo or video of the issue.
3. Contact us through the platform's customer service.

## ② Light source and lampshade assembly:

- (1) Take out the mounting plate and connect it to the ceiling.
- (2) 4 pieces of 120MM rectangular support locks on the top of the square pipe.
- (3) Lock the D490 large double-layer flat iron ring on the No.2 square support.
- (4) 4 rectangular support locks of 270MM length on the upper square pipe
- (5) Lock the D250 large double-layer flat iron ring on the No.4 square support.
- (6) Connect the main power line to the lamp body main line and secure the ceiling plate.
- (7) Use flower branches to fix the ceiling pot.
- (8) Fit the E12 bulb into the lamp holder.
- (9) Hang the 22\*120 crystal strip on the flat iron.
- (10) Installation completed

