

SECOND
STORY
HOME

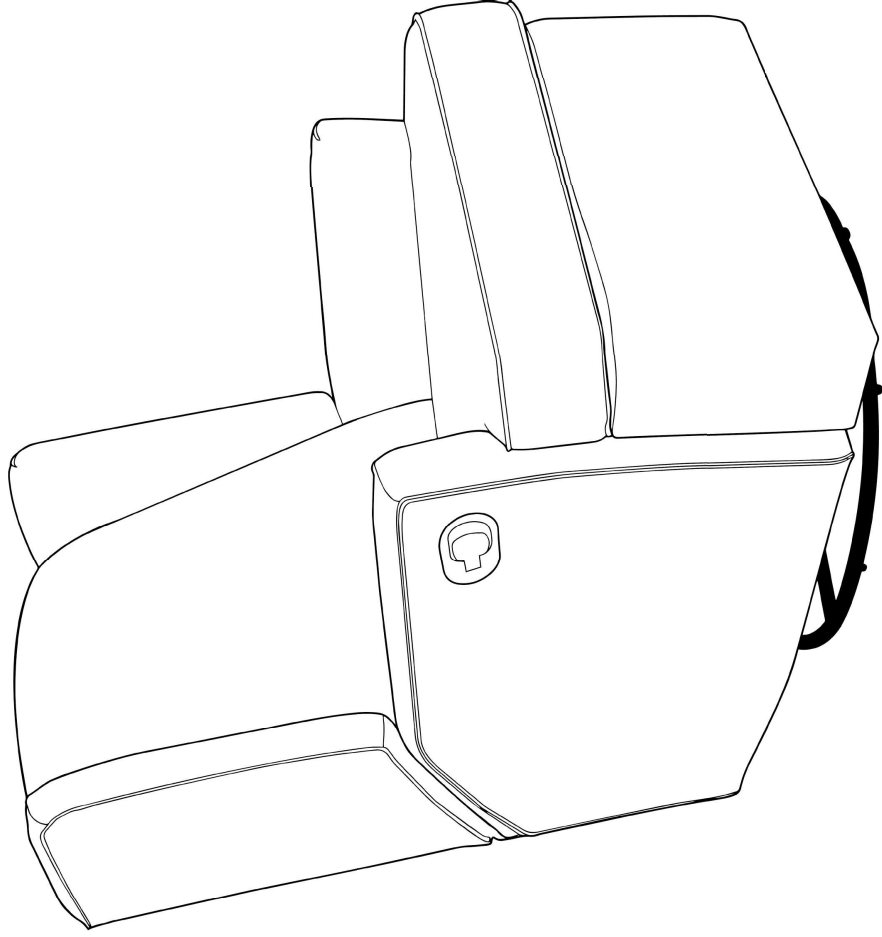

Hemingway Instructions

Swivel Recliner



Parts Guide

Left Wing and Right Wing

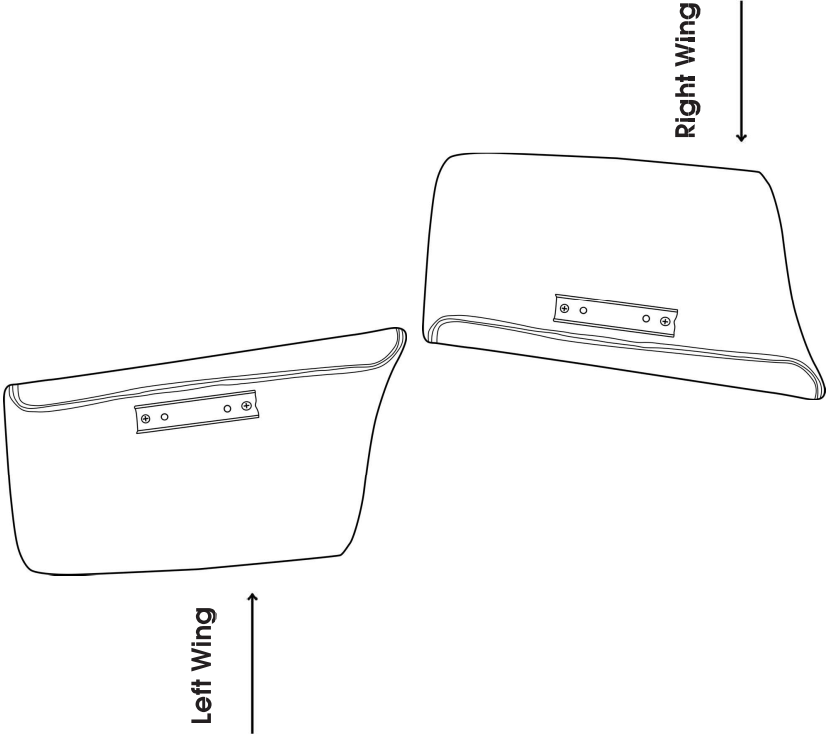

Back Support

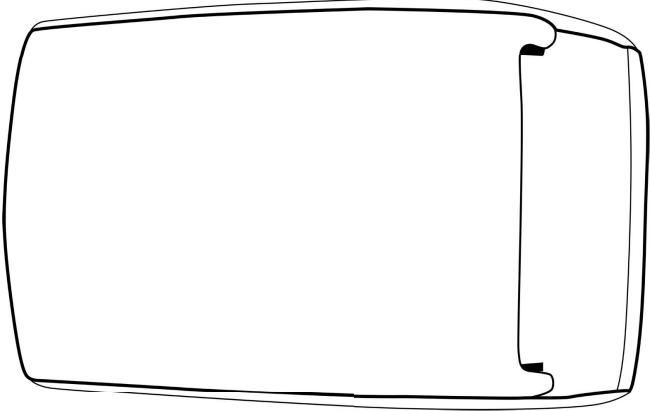

Base

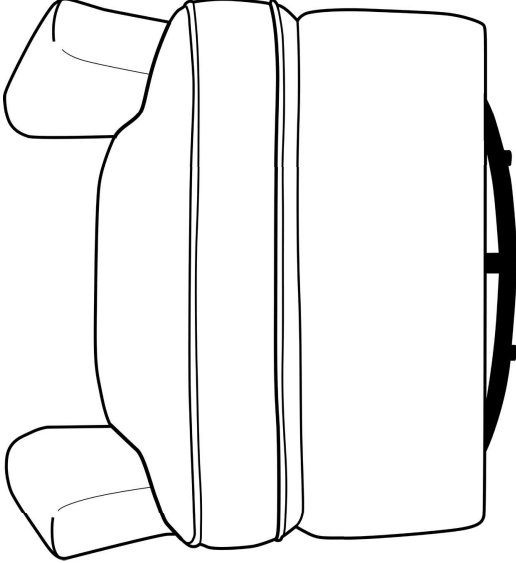

1.

Insert back support to base.

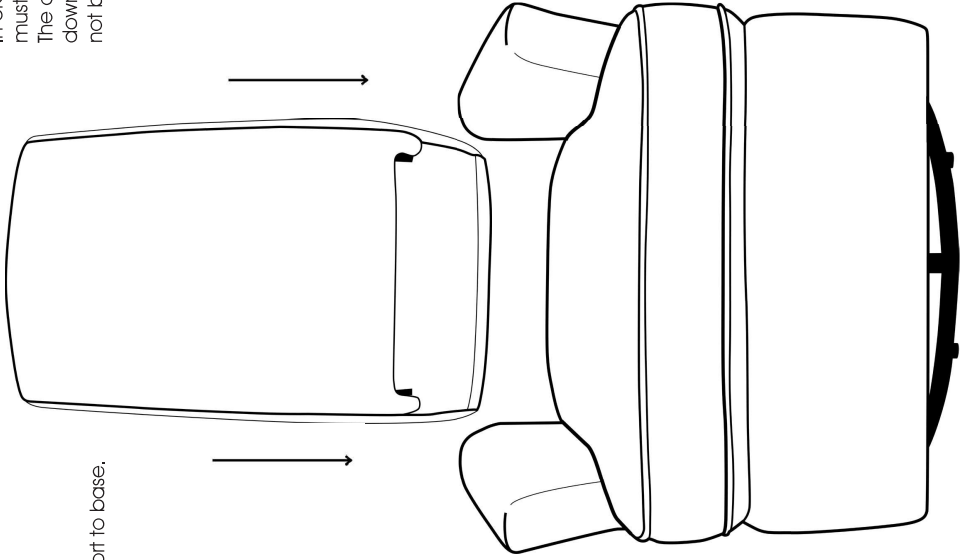

In order to connect the back support with the chair base, you must align the back support connector with chair base connector. The chair base will go inside the back support as shown. Press down until you hear a click. Once it is properly secured, you will not be able to lift it back up.

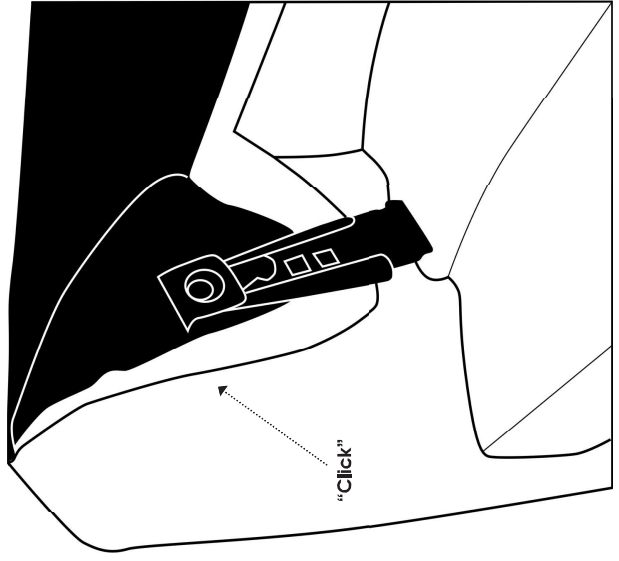
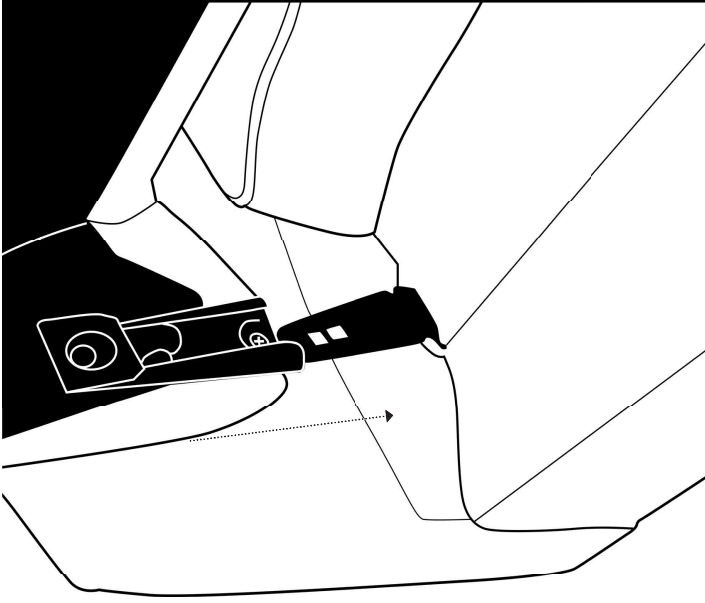

2.

Align the Left Wing to the corresponding metal brackets on the Back Support and push the wing down. Repeat for the Right Wing.

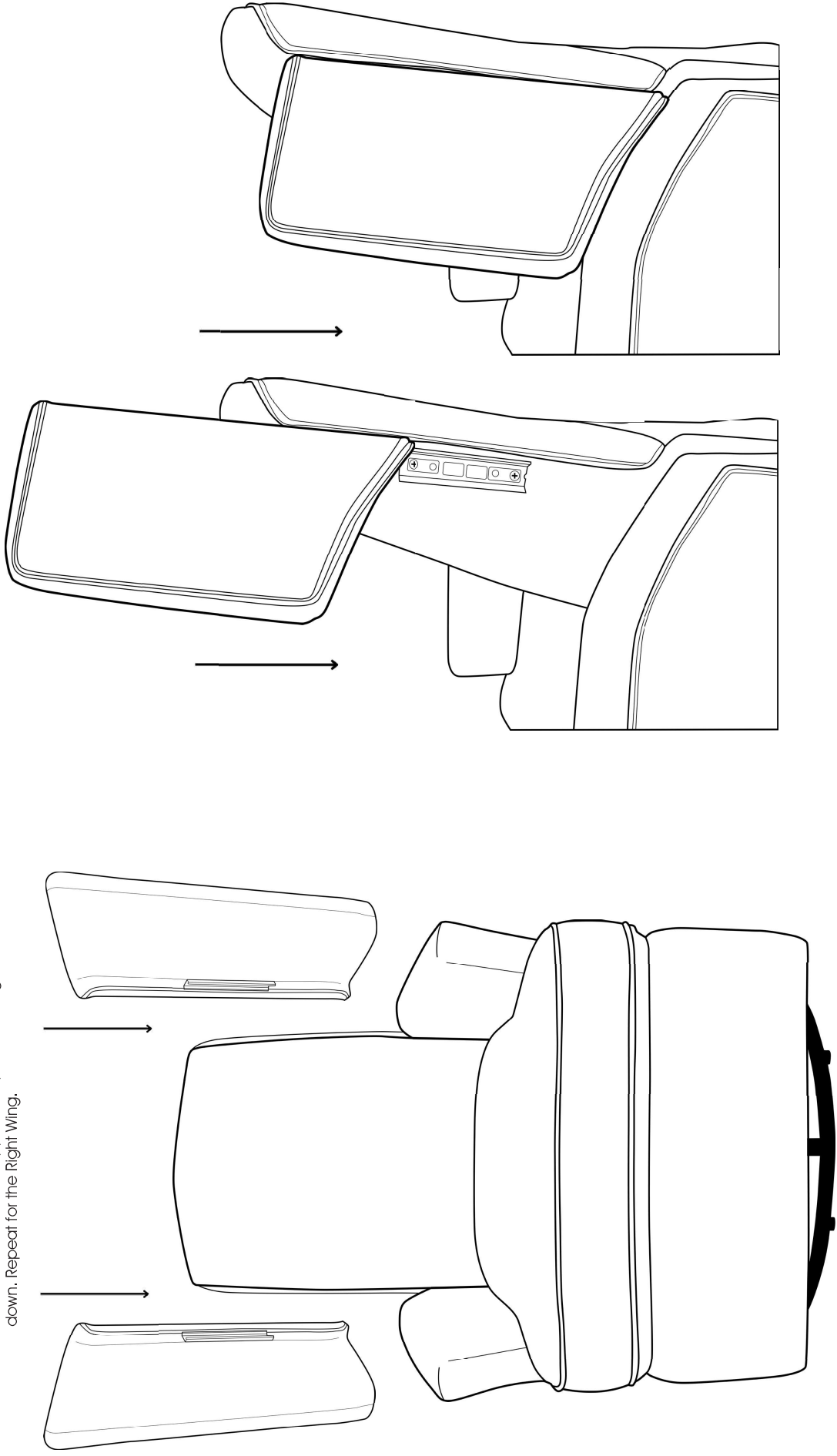

3.

Last, pull down the flap of the back support and match it to the strips of velcro on the chair base. One on each side and one directly under the chair base.

