

Parts Included

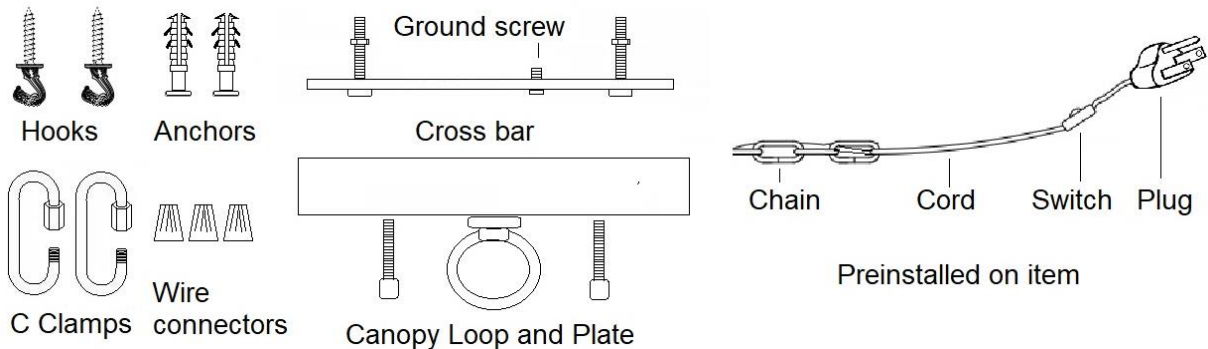

Plug-In - ASSEMBLY INSTRUCTIONS

Your lamp is ready to be installed as a Plug-In lamp, the Cord with Switch and Plug are already installed!

- Install the two provided wall anchors on the desired location, they must be anchored to a structure that can support 25 Lbs. or more.
 - NOTE: Make sure to measure the distance from the desired location to the nearest electrical wall outlet, the wire total length is 15 feet, the chain is 9 feet long.
- Thread the two Hooks to the Anchors, then adjust the chain's length based on the ceiling's height.
- Install the BULB(s) (Not included)

⚠ CAUTION - Refer to the wattage caution label located near the lamp holder for maximum wattage - do not exceed the maximum wattage.

⚠ WARNING - Do not attempt to replace the bulb(s) while the lamp is plugged into a wall receptacle

- Hang the lamp from the Chain to the Hooks and plug it to a wall receptacle.

⚠ WARNING - Do not hang the lamp by the wire, always hang from the Chain.

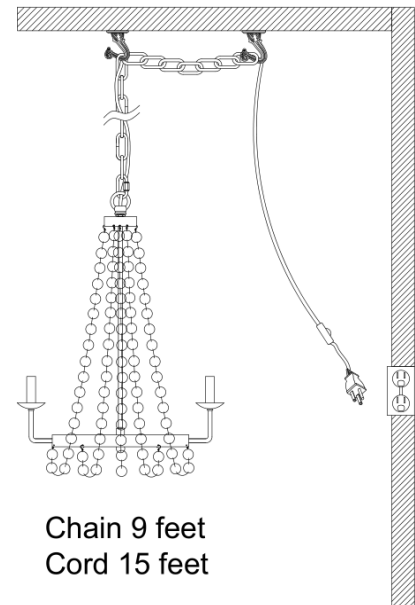

Plug-In Diagram

E12 Type B, 25W X 6 (Not included)

E12 CFL 5W X 6 (Not included)

Note: The above diagram is a representative drawing, it is not intended to match the shade style.

Hardwired - ASSEMBLY INSTRUCTIONS

“Professional Installation recommended”

1. **⚠ CAUTION** - Before starting the installation, disconnect the power by turning off the circuit breaker or by removing the fuse at the fuse box. Turning the power off using the light switch is not sufficient to prevent electrical shock.
2. Your lamp is assembled with the Cord, Switch and Plug out of the box, once the desired new *HARDWIRED* location is selected measure to measure the hanging distance from the ceiling.
3. With pliers open the Chain link to the desired length, then cut the wire at least 12 inches longer than the chain. This will ensure it will be long enough to make the connections to your electrical installation.
4. Fasten the Crossbar to the outlet box securely.
5. Pass the Cord through the Canopy Loop and Canopy Plate.
6. Make the electrical connections (two people recommended): the lamp has three encased wires, look carefully to identify the **Green** and **White** ribbed wires, then continue as follows using the provided Wire connectors:

⚠ WARNING – Failure to connect the wires following the below instructions will result on bodily harm and a fire hazard!

- a. Connect the lamp **Green** ribbed wire to the Cross bar green Ground Screw along with your installation ground wire.
 - b. Then connect the lamp **White** ribbed wire to the Negative wire in your installation.
 - c. Finally connect the last wire from your lamp to the Positive/Live wire in your installation.
7. Using the C Clamp connect the Chain to the Canopy Loop.
 8. Lastly secure the Canopy Plate to the Cross bar firmly using the provided screws.

⚠ WARNING

Follow wires connection instructions detailed in the instructions.

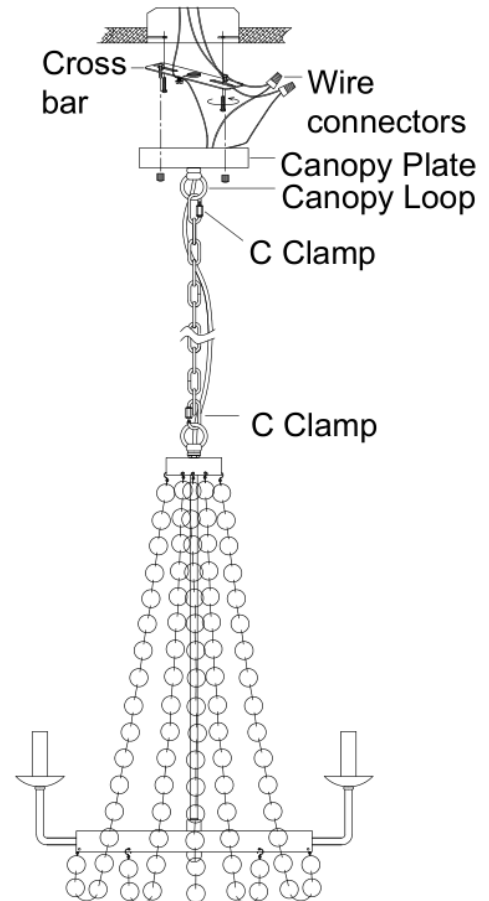

E12 Type B, 25W X 6 (Not included)

E12 CFL 5W X 6 (Not included)

Note: The above diagram is a representative drawing, it is not intended to match the shade style.

CARE INSTRUCTIONS - Use only a soft cloth; do not use any chemicals or abrasive cleaners.

