

Metal Bookcase

Installation Instructions

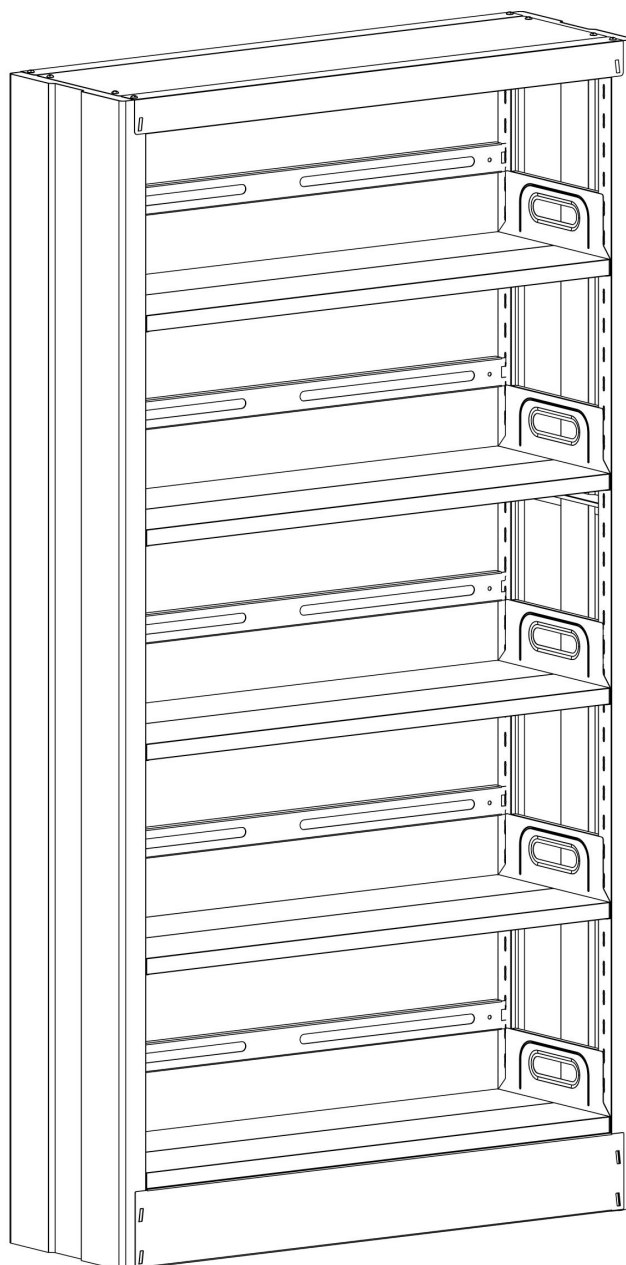

Thanks for choosing our goods. Before Install the goods must read carefully on our instal manual first if still have install problem or other things can contact our after-sales team.

Bookcase Accessories

A ×2

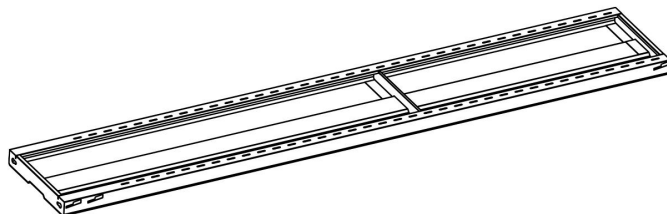

B ×2

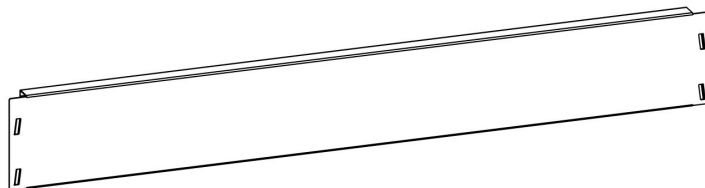

C ×2

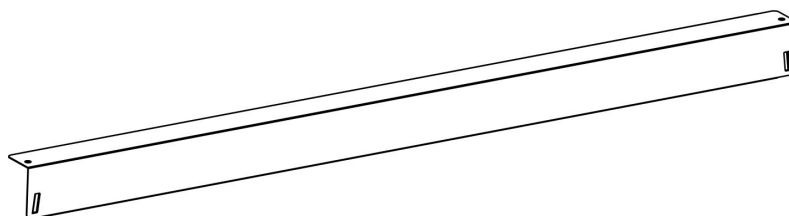

D ×1

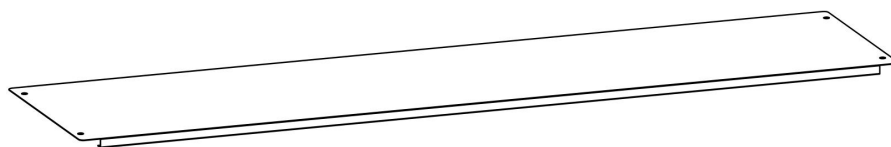

F ×10

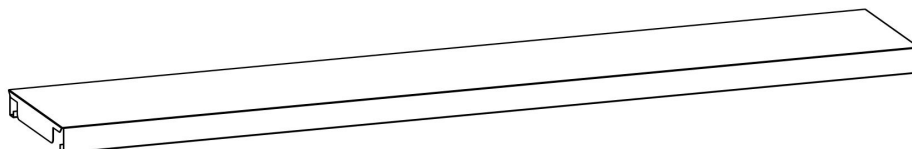

G ×5

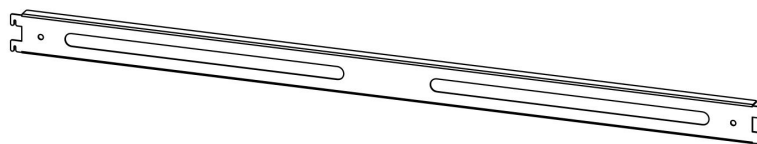

E ×10

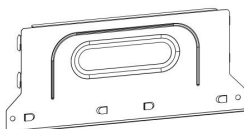

H ×4

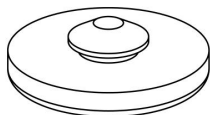

I ×2

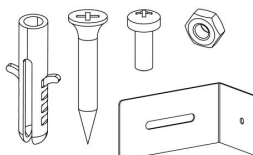

J ×8 (M5*10)



Step1

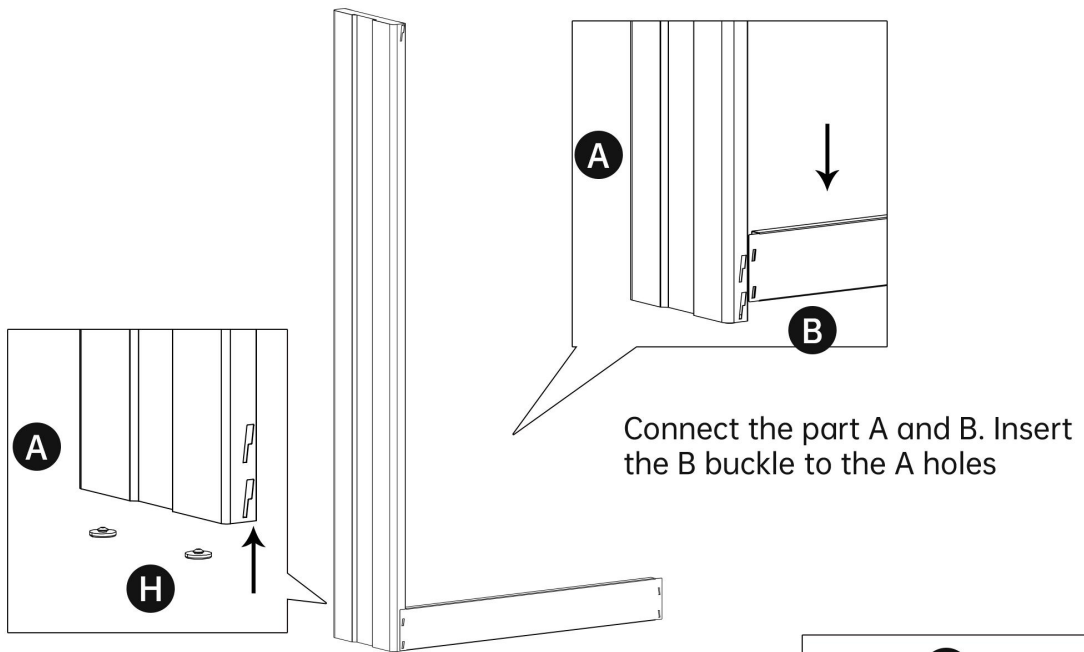

Tape part H to the bottom of part A. Please be careful to distinguish between the bottom and top of part A. Those with two holes in the side are the bottom and those with one hole are the top.

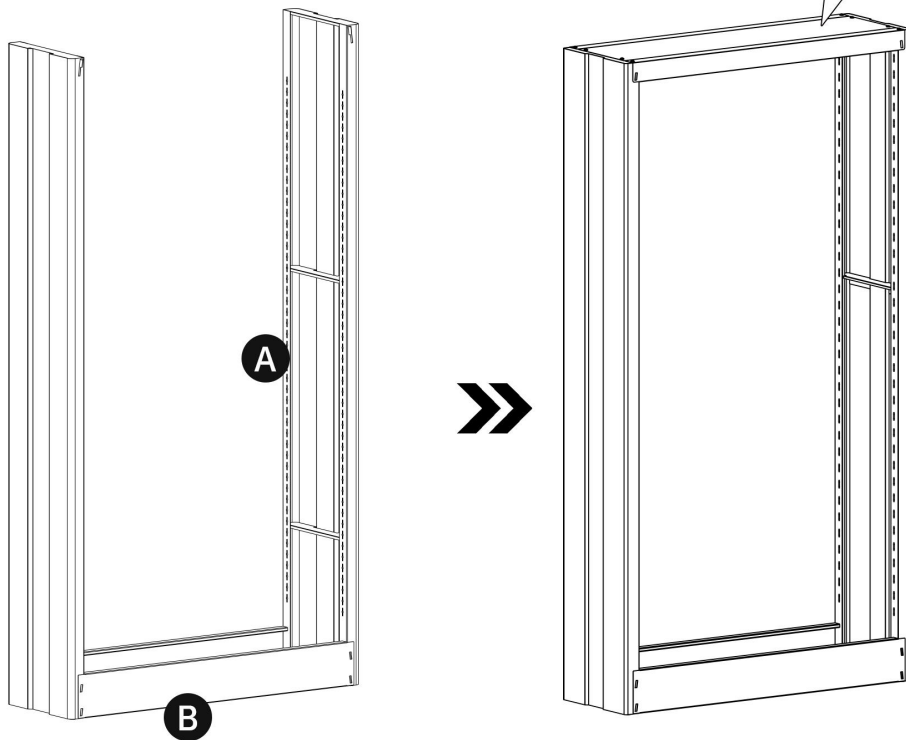
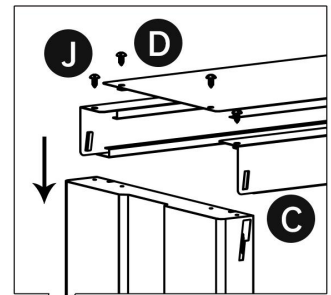

Install the another part B. Then side same way connect the part A and B.

Install the top part C and D with J. Insert the C buckle to the A holes

Step2

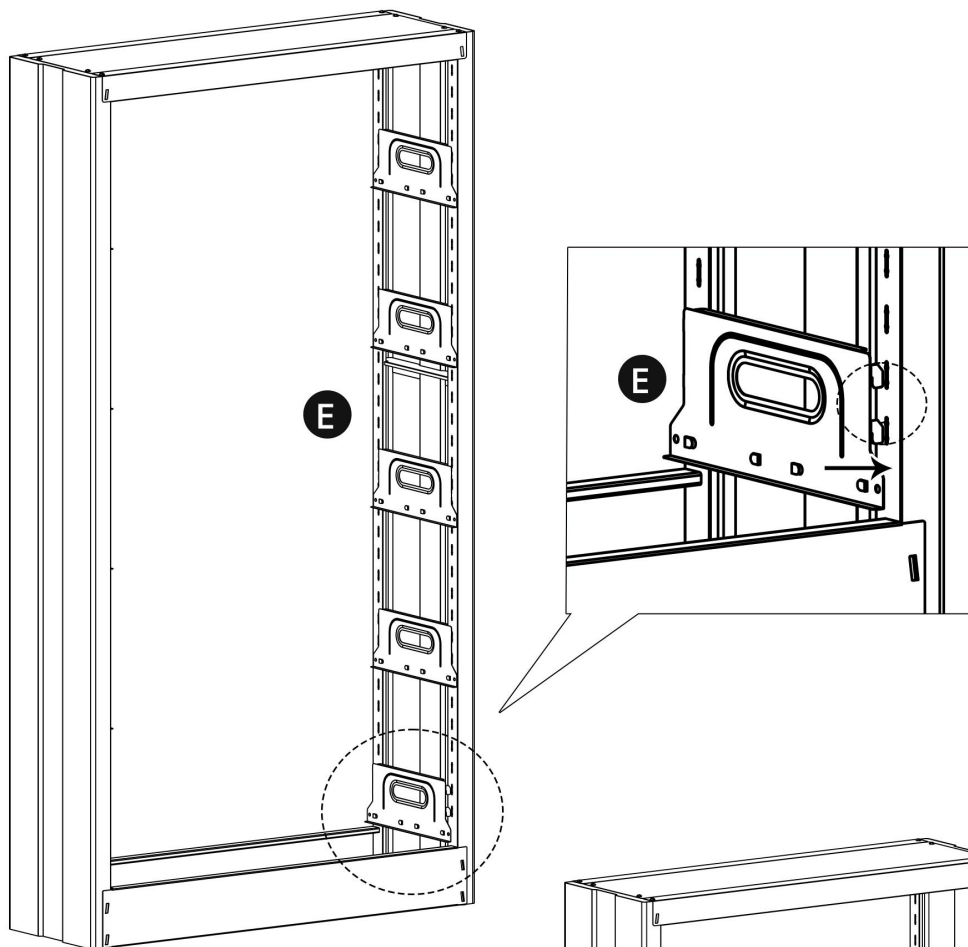

Install the part E to the A part holes. Part E wide side down. The two sides part E should in the same level.

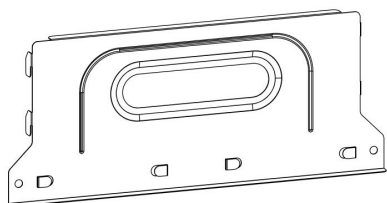

E ×10

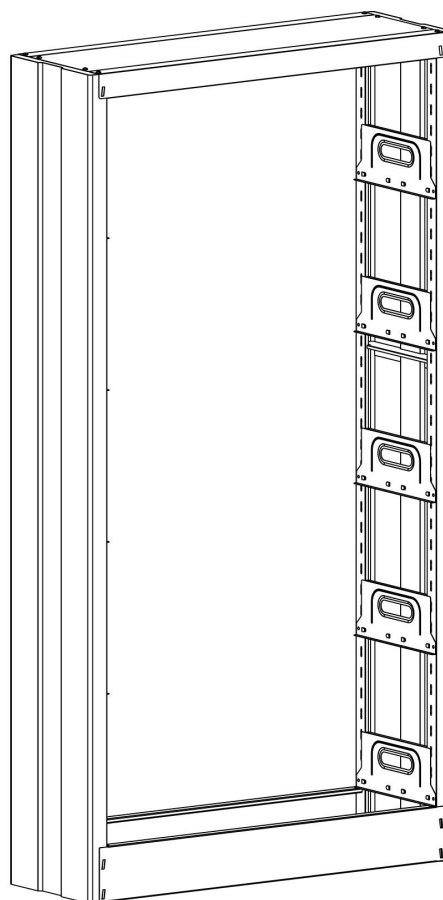

Step 3

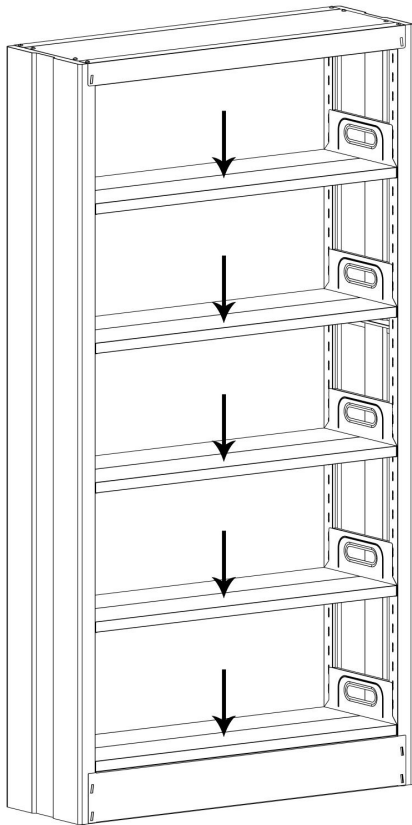
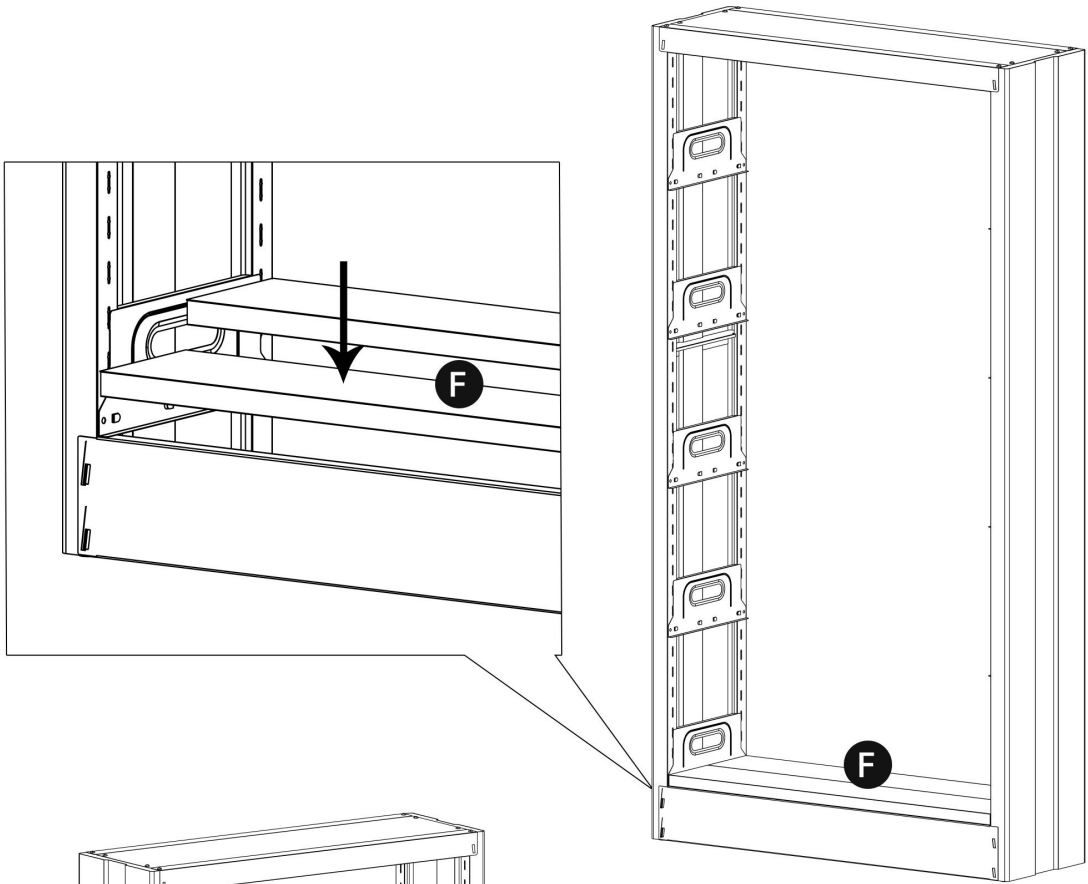

The part F shelf put on the part E.

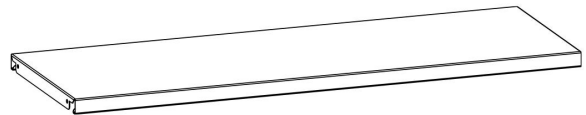

F × 5

Step4

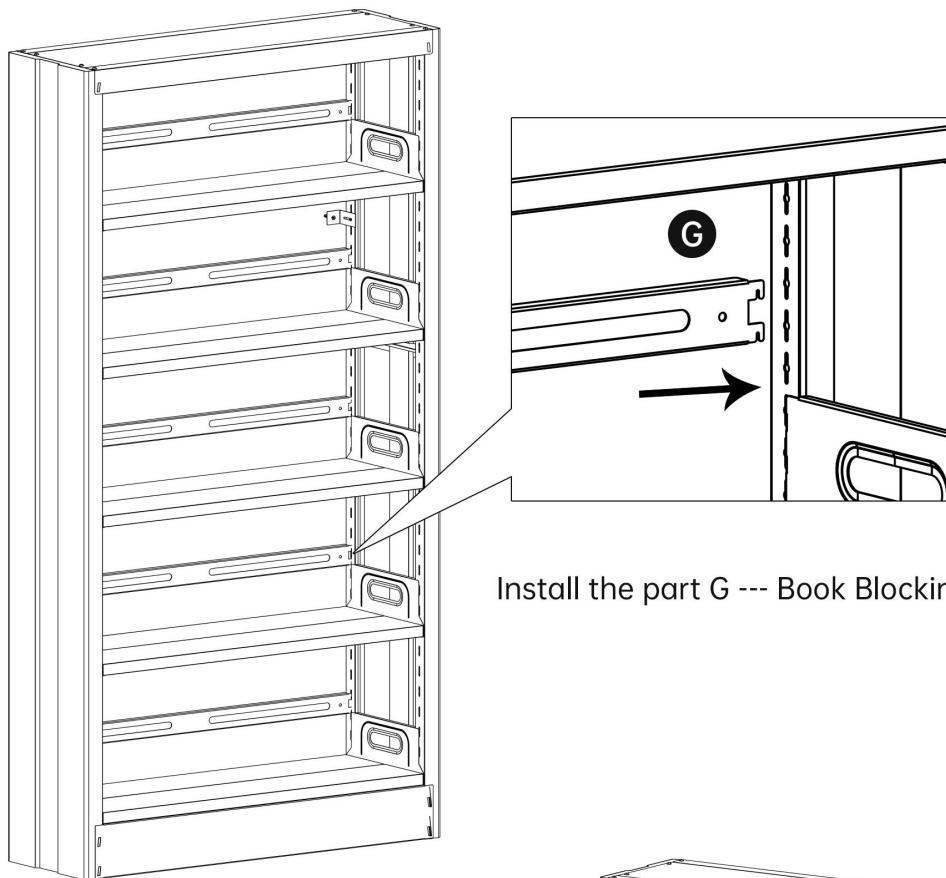

Install the part G --- Book Blocking Strip.

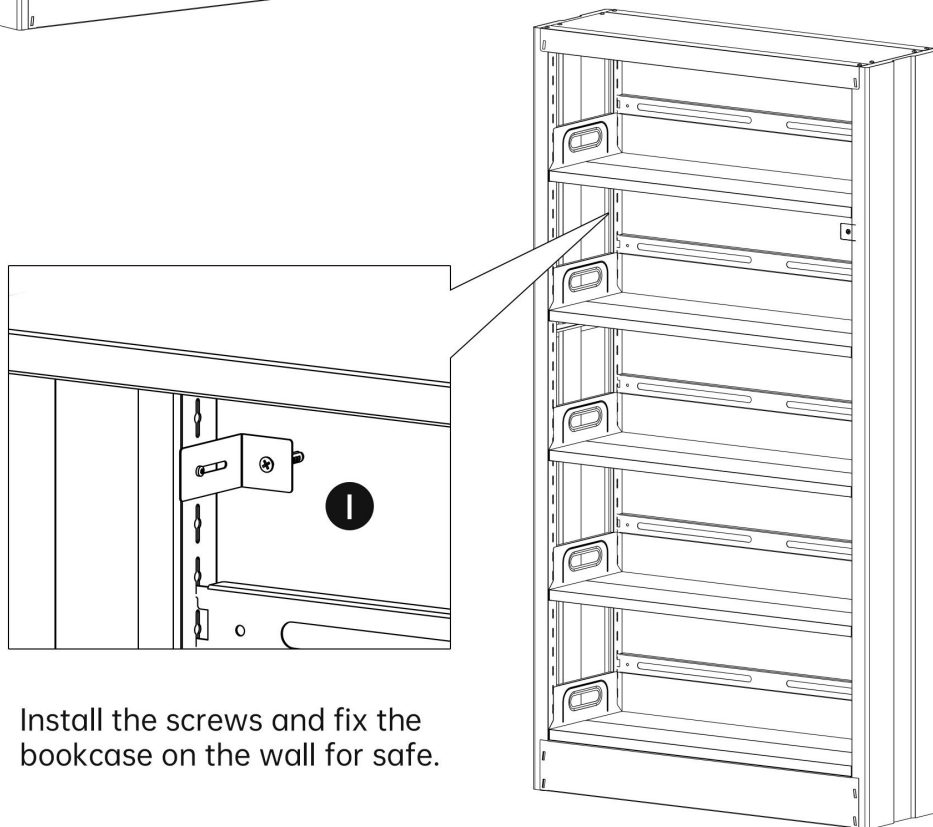

Install the screws and fix the bookcase on the wall for safe.