

Assembly Instructions

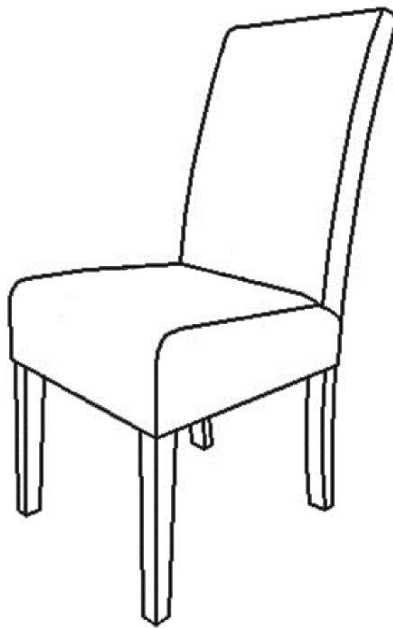

Caution: You must read this before you proceed.

Please look in the bottom of seat frame for hardware packs and legs. Sets often ship in multiple boxes and may arrive a day or two apart



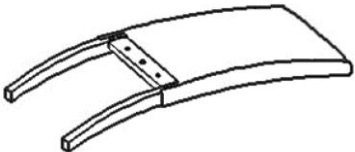
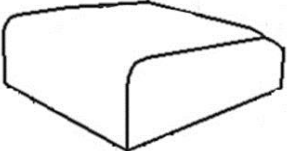

Dining Chair

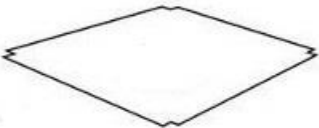

Parts List

Label	Picture	Description	QTY
A		Chair Back	1
B		Chair Seat	1
C		Wooden Leg	2
D		Seat Base Cover	1

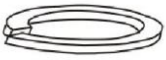
Hardware

Label	Picture	Description	QTY
①		Bolt M8X75	5
②		Bolt M8X45	7
③		Flat Washer Ring	11
④		Spring Washer Ring	11
⑤		Allen Key	1

Assembly Preparation

Before Beginning Assembly:

Unpack all the parts for a clear overview.

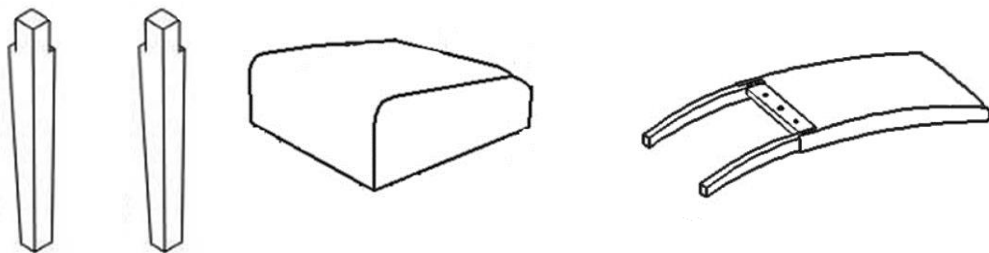

Pack A for Locking the front legs to the front corner blocks of the seat:
Four Dia.M8 Bolt:45mm(L)+four flat washer+four spring washer

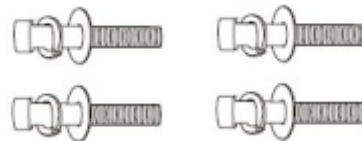

Pack B for locking the back panel of the seat to the horizontal panel of the backrest:
Four Dia.M8 Bolt:75mm(L)+one Dia.M8 Bolt:45mm(L)+five flat washer+five spring washer



Allen Key





- Read instructions, cover to cover-



- Have 2 adults on hand for assembly-



- Do not assemble on flooring or carpet-



- Assemble on a clean non-marring surface (packing foam)-



- Save all packaging until finished-

Assembly Steps

Parts Introduction

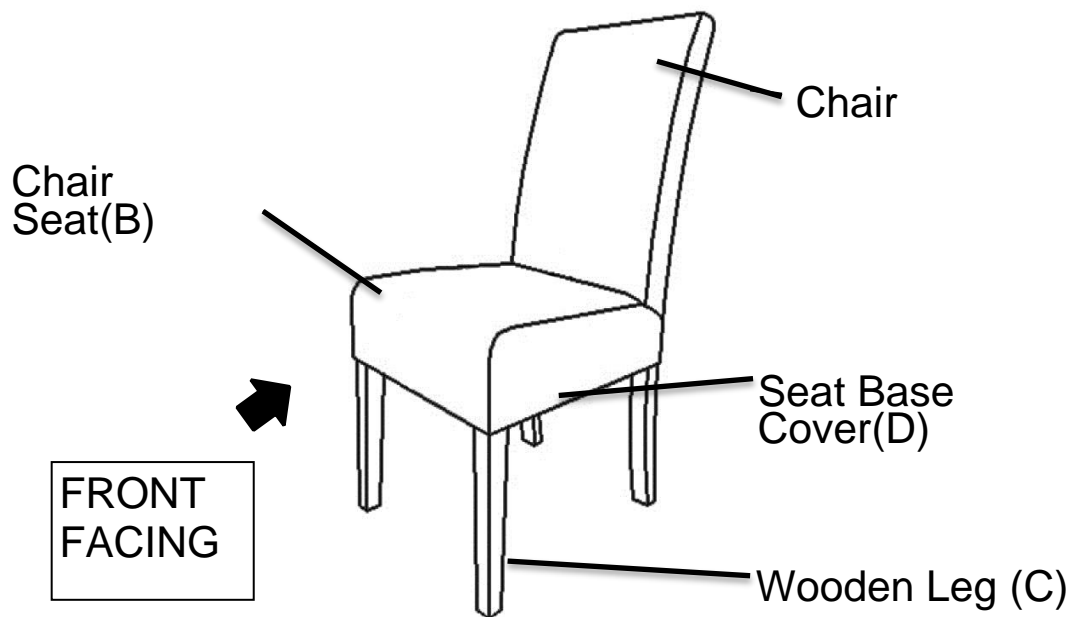

This Push Back Chair has multiple parts and may require up to some 30 minutes to assemble. To give you an overview of the Chair parts, the above picture is to help you put the various parts into perspective. Please read through the instructions below to familiarise yourself with the parts and steps before assembly.

Step 1

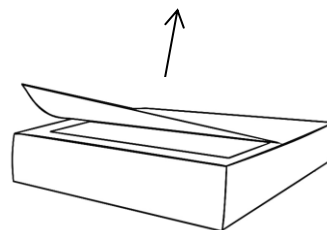
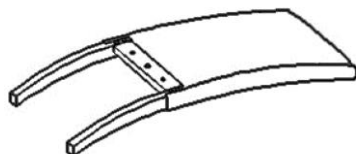

Place the Chair Back(A) on a soft surface to avoid any scratches or damages to the product.

REMOVE the Seat Base Cover from the Chair Seat(B), take out the front legs and hardware accessories.

Step 2

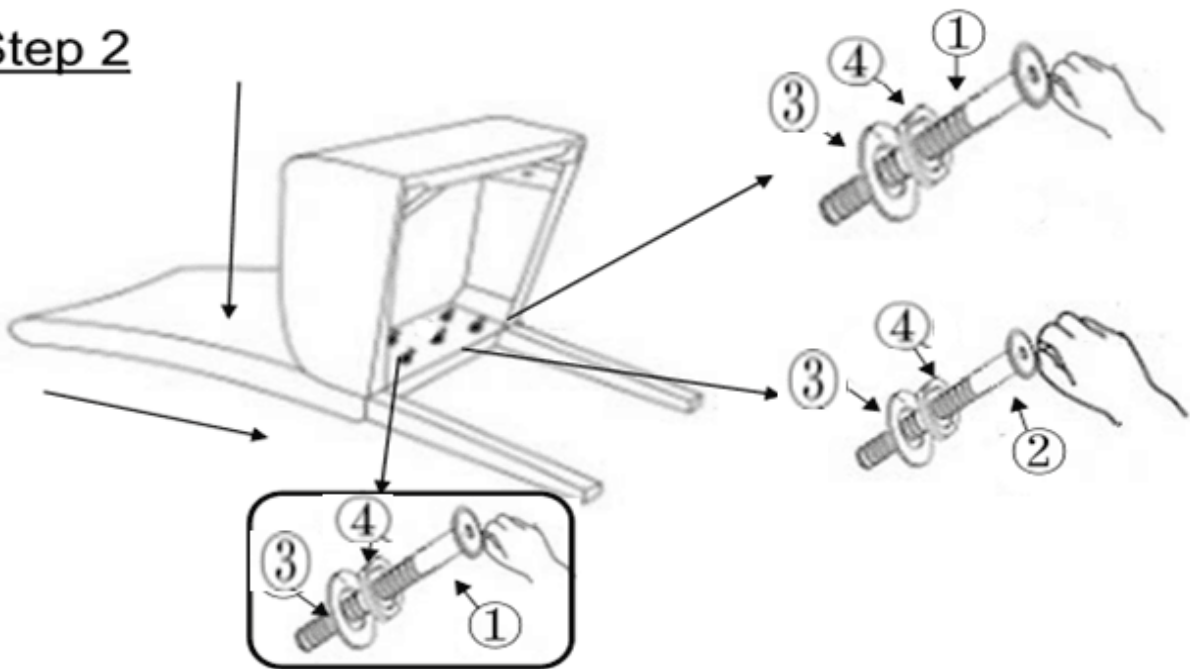

Put the chair back(A) onto a flat table or panel.

Align the positioning dowels on the Chair Seat with the mounting position located on the Chair Back- panel and Chair - Seat panel.

Use your left hand to push the seat frame floorwards, depicted by Arrow 1.

This action helps to ensure the chair seat(B) is pressed towards to the chair back(A) with no gap between these.

Then, lock the one middle hole(use Bolt②) and the four corner mounting positions later.

The hardware for these are : use Bolts (①)+ Bolts (②)+ Flat Washers (③) + Spring Washers (④) with the Allen key(⑤).

At this point of assembly, DO NOT overfasten the connections.

Step 3

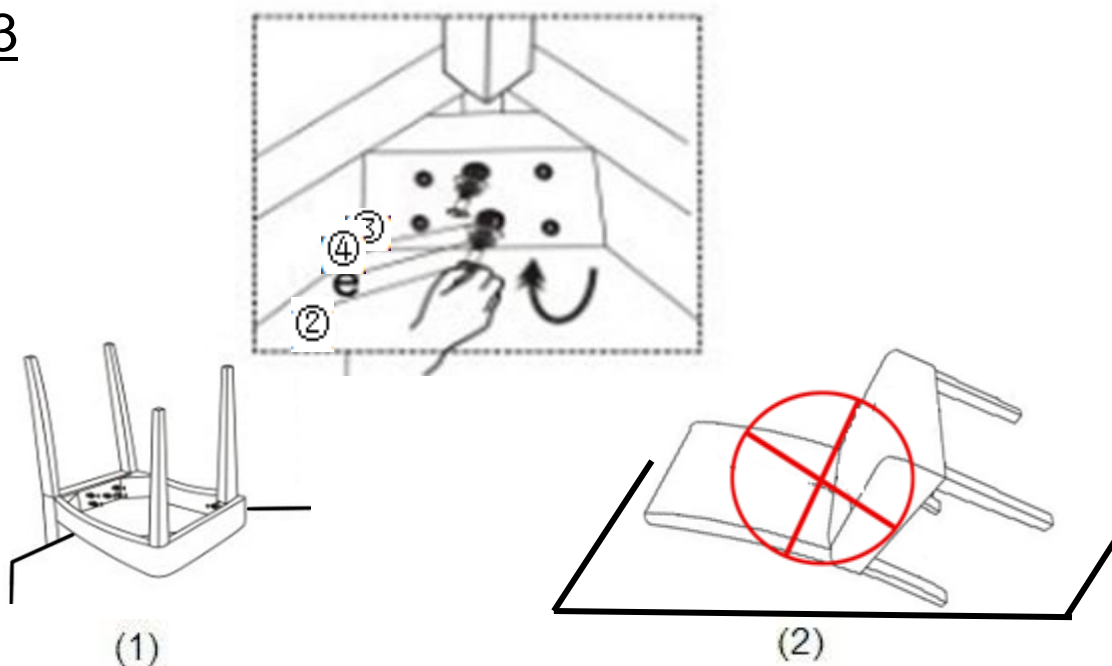

Next, place the chair onto the side of a table as seen in Picture 1. You will now have the chair bottom and all 4-legs facing skywards. Insert each front leg completely vertically into each seat frame corner. **PRESS FIRMLY DOWN** with your hand until there is no gap. **WARNING!! DO NOT POSITION THE FRONT LEG AS SHOWN IN PICTURE 2 .** THIS PICTURE SHOWS THE CHAIR BACK STAYS AGAINST THE GROUND and THE FRONT LEGS HORIZONTAL IN MIDAIR. Now tighten the bottom bolt first, then the bolt on the top by using Bolts (②) and Flat Washers (③) and Spring Washers (④). **DO NOT** tighten the top bolt first. **WARNING!! DO NOT OVER TIGHTEN. OVER TIGHTENING COULD LEAD TO DAMAGE OF THE PRODUCT.** TIGHTEN ONLY UNTIL SECURE AND STABLE.

Step 4

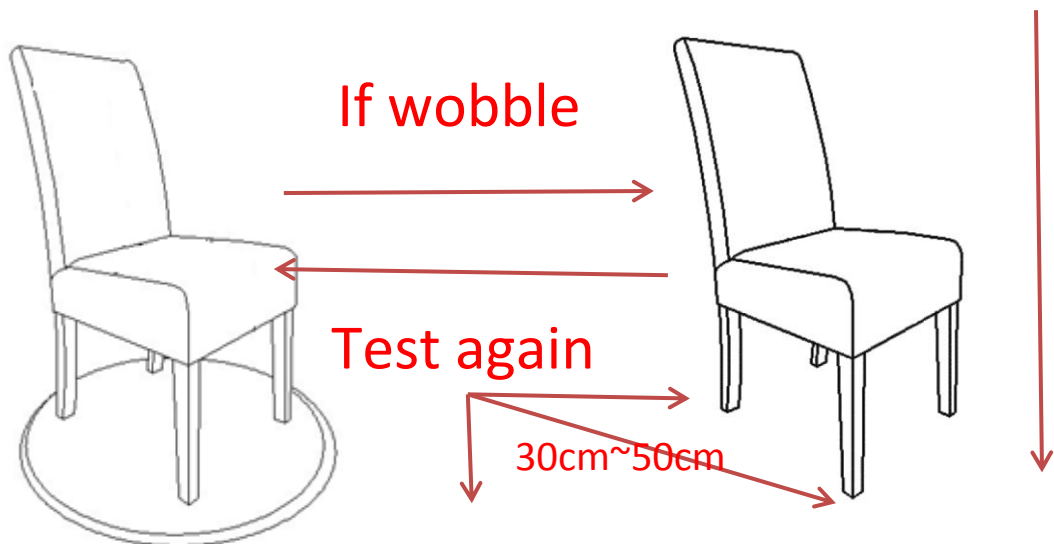





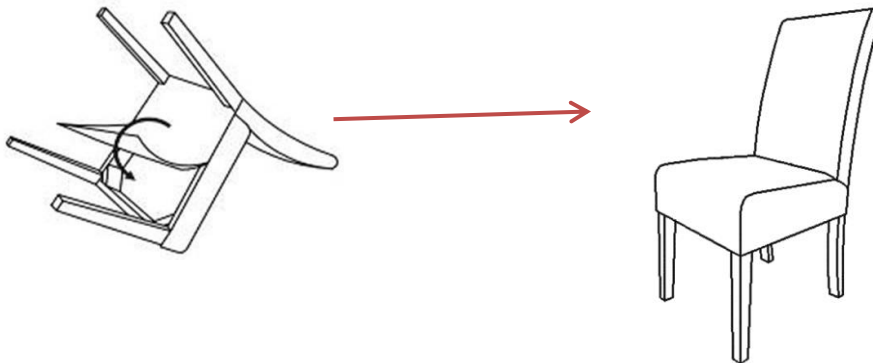















Place the chair on a LEVEL SURFACE to see if it wobbles.
If it wobbles, lift the chair to some 30cm to 50cm height from the ground.
Keep your feet and toes well away from the drop zone.
Drop the chair freely and vertically with the four legs, hitting the ground, at the same time.
This Drop Test will help to ensure that all the bolts and gaps to all reach full alignment status.
Test again for evenness on a LEVEL SURFACE.
If no wobbles found, proceed to tighten all the bolts.
CAUTION : When tightening these bolts, tighten sequentially.
DO NOT tighten any screw fully and then towards the next one.
This would cause the frame to warp.
If there is still wobbles, loosen the bolts and execute this same drop tests.
WARNING!! IF CHAIR IS NOT STABLE , IT COULD LEAD TO DAMAGING THE PRODUCT.

Step 5



Finally, seal the Seat Base Cover back on to the underside of the chair seat . Turn it the right side up.
Make sure all parts are connected and securely locked into position.
Your Chair is ready for use.
This Club Chair can only be used on a flat, level surface.

Care & Maintenance

-   ● Do not put hot items directly on furniture surface
 -   ● Do not clean furniture with harsh cleansers or polish.
 -   ● Do not place furniture under direct sunlight.
 -   ● Do not place furniture near heating or cooling vents.
 -   ● Do not write on furniture without a padded barrier to protect the surface.
 -   ● Do not place furniture outside . For indoor use only .
 -   ● Not for commercial use. For residential use only .
 -   ● Stains may be removed with mild soap solution and damp cloth.
 -   ● Children should not climb or jump on the furniture.
-
-   ● Dust and pick-up spills using a clean, non-colored, lint-free cloth .