

Assembly and Installation Guide

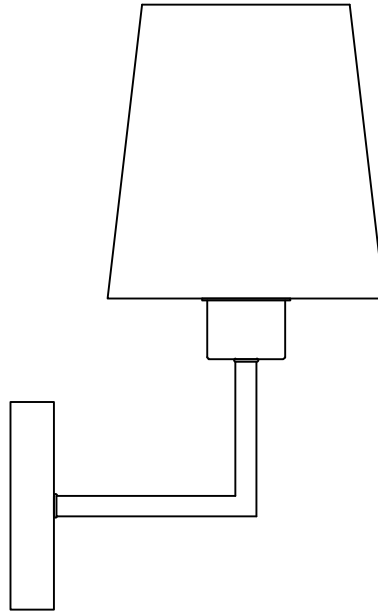





IMPORTANT:

Please read carefully and save these instructions, as you may need them at a later date. When using electrical equipment, basic safety precautions should always be followed as below:

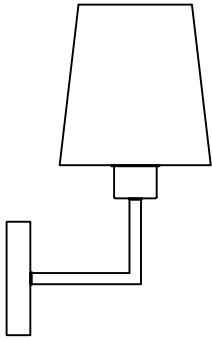
- 1.The lamps are recommended to be installed by authorized and qualified technicians in accordance with valid electrical installation regulations.
- 2.The manufacturer does not accept any responsibility for injuries or damages resulting from improper use of the light.
- 3.Attention! Before starting the installation work, make sure that the mains power line is voltage-free-turn off safety cutout or unscrew the protection fuse. The switch must be "OFF".
- 4.Warning! Before drilling the mounting holes, make sure that no gas, water or electricity pipes and wires can be drilled through or damaged in your chosen mounting location.
- 5.No user serviceable parts inside.
- 6.Place the device out of reach from children under 3 years old.
- 7.Risk of electric shock-do not use where directly exposed to water.
- 8.Description of the supply terminals: L=Phase N=Neutral conductor ⊕ =Earthed conductor

Installation Instruction



LIGHTING SOURCE	 x1	INCLUDED	<input checked="" type="checkbox"/>
		NOTINCLUDED	<input type="checkbox"/>
Mounting plate	 x1	INCLUDED	<input checked="" type="checkbox"/>
		NOTINCLUDED	<input type="checkbox"/>
Mounting screws	 x2  x2	INCLUDED	<input checked="" type="checkbox"/>
		NOTINCLUDED	<input type="checkbox"/>

1

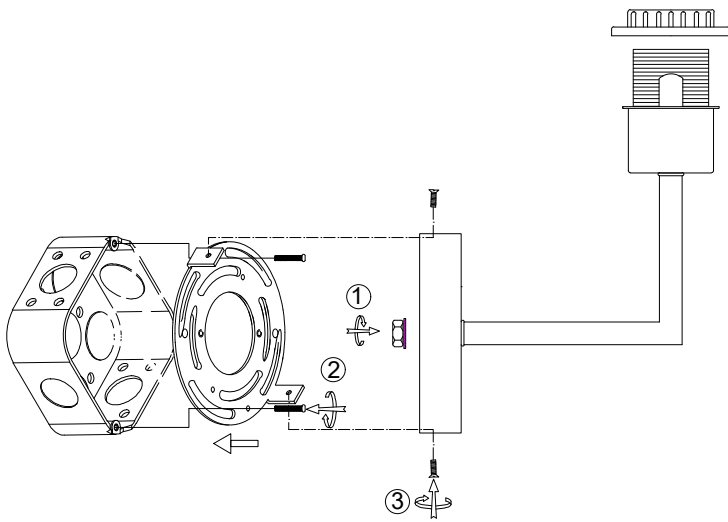

3

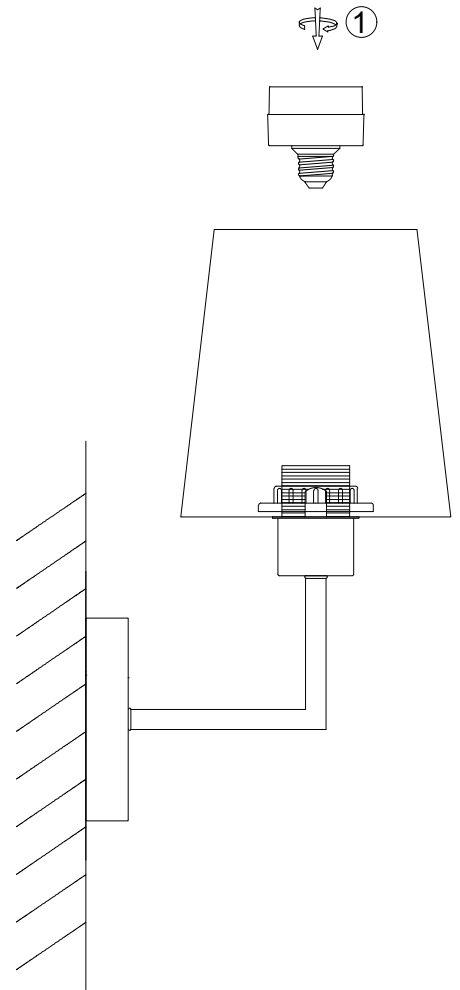

2

