

INSTRUCTIONS

ANWEISUNG

取扱説明書

INSTRUCTION

제품 설명서

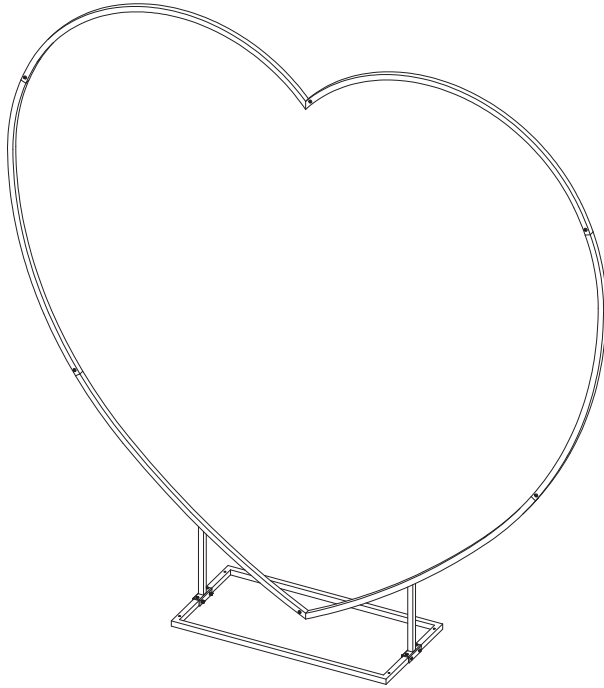

①\*1

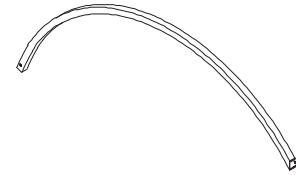

②\*1

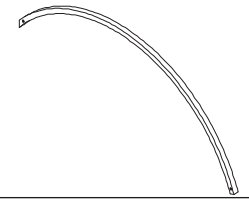

③\*1

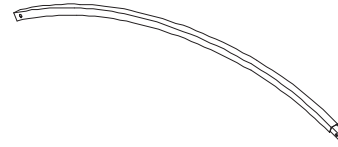

④\*1

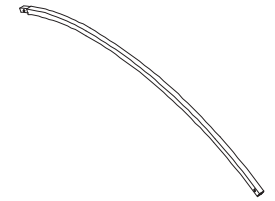

⑤\*1

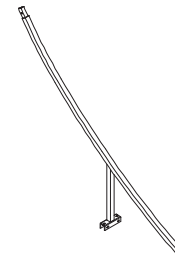

⑥\*1

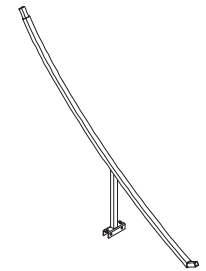

⑦\*1

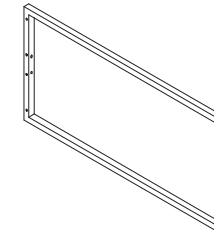

EC REP

UK REP



FR

Ce meuble se recycle,  
s'il n'est plus utilisable  
déposez-le en déchèterie.  
Notice à trier.

A\*10



M6x10

B\*4



M6x35

C\*4



D\*1

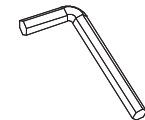

M4

E\*4

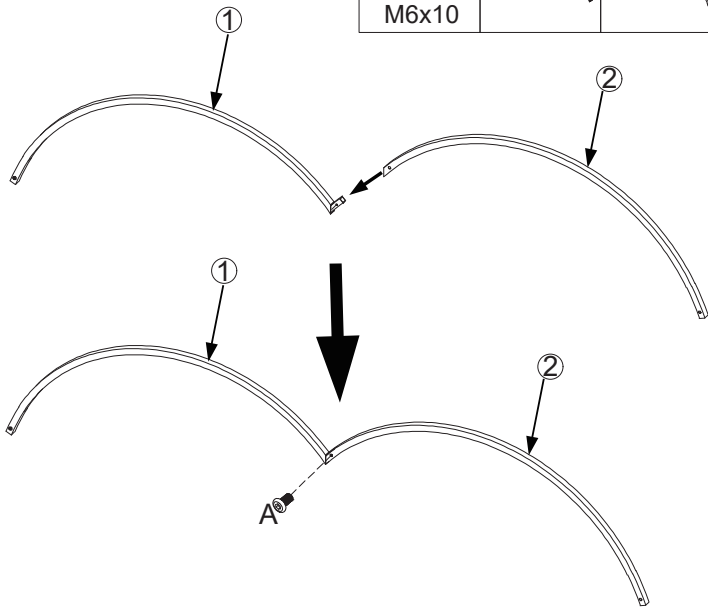
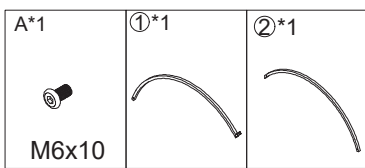
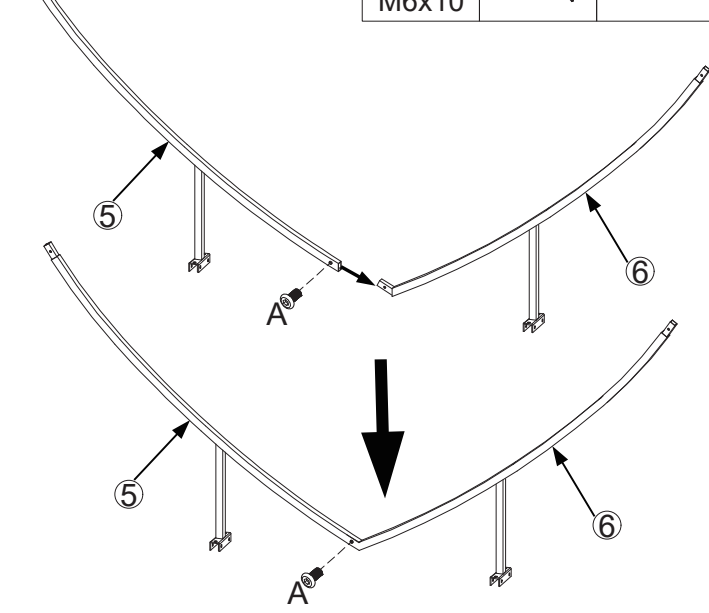
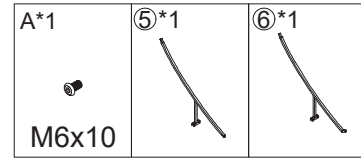
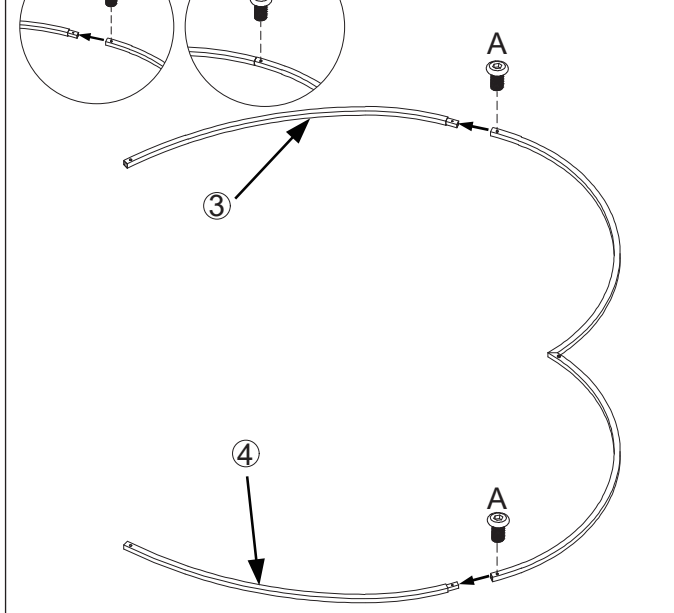
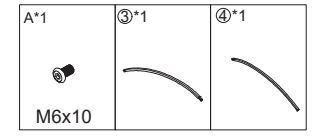
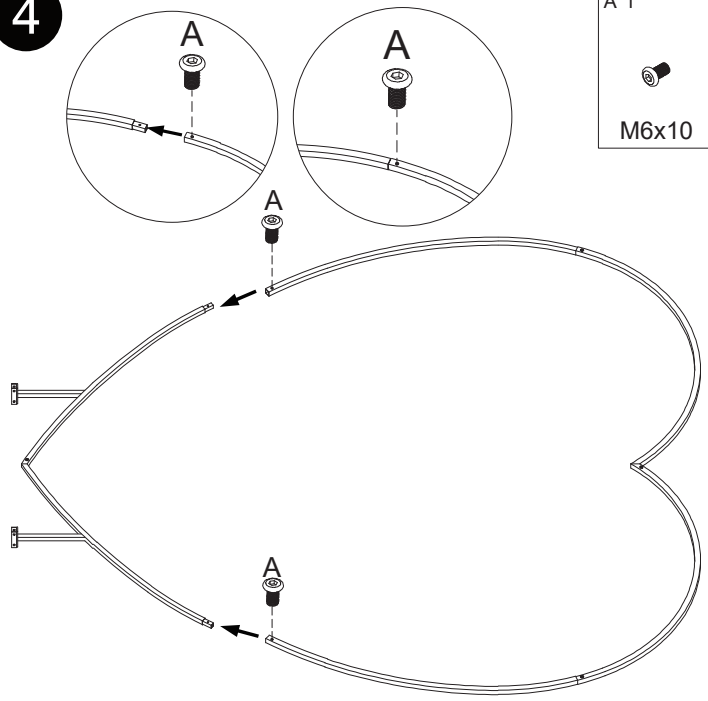
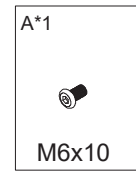
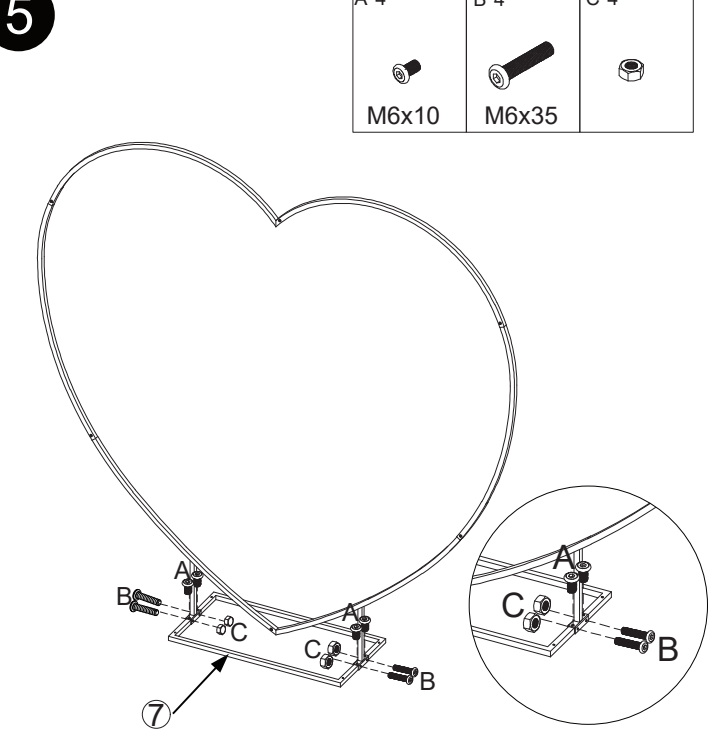
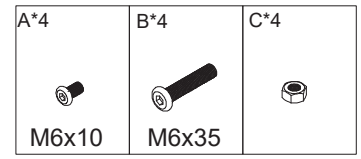
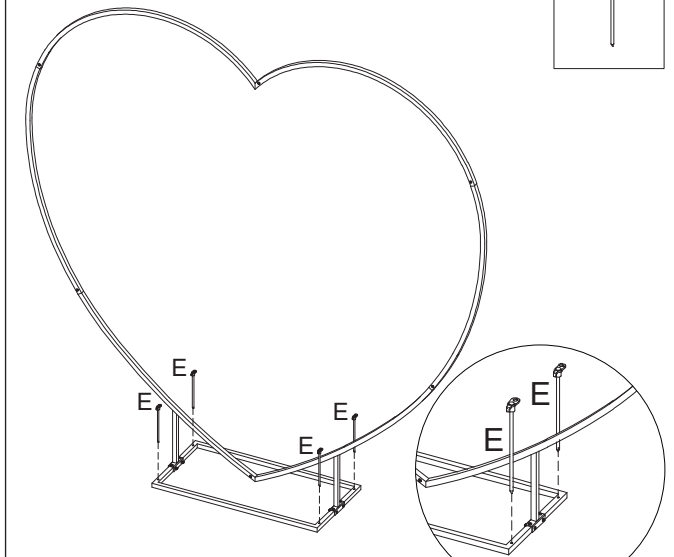
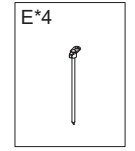

**1****2****3****4****5****6**

Use tools to drive the ground nails into the muddy ground  
 Schlagen Sie die Erdnägeln mit Werkzeugen in den schlammigen Boden  
 ハンマーなどの工具でくいを地面に叩き込んでください。  
 Enfoncez les piquets dans le sol boueux avec des outils  
 망치 등의 공구로 말뚝을 땅에 박아 주십시오.