

WARNING

- * Switch off the main electrical supply from the main fuse box / circuit breaker before installation.
- * Inspect item carefully before attempting to install.
- * If there is any damages or obvious defects, do not install.
- * Item may not be returned once it has been installed.













CARE AND MAINTENANCE

- * To clean the outside of the fixture, use a dry or slightly dampened clean cloth (use clean water, never a solvent) to wipe the surface of the fixture.
- * To clean the inside of the fixture, first disconnect power to the fixture by turning off the circuit breaker or by removing the fuse at the fuse box. Next, use a dry or slightly dampened clean cloth (use clean water, never a solvent) to wipe the interior surface of the fixture.
- * Do not use any cleaners with chemical, solvents or harsh abrasives. Use only a dry soft cloth to dust or wipe carefully.

NOTICE & IMPORTANT SAFETY INSTRUCTIONS

- ** WE RECOMMEND INSTALLATION OF THIS LIGHTING FIXTURE BE DONE BY A LICENSED ELECTRICIAN **
- * Please make sure that you have all parts indicated before you begin assembly of this item
- * This item should be assembled on a soft surface to prevent scratching the finish during assembly
- * To reduce the risk of fire, electrical shock or injury to persons or property, please follow the guideline below for safe use and installation
- *The external flexible cable or cord of this lamp cannot be replaced
If the cord is damaged, the lamp shall be destroyed

Part List and Hardware List

PIECE	DESCRIPTION	PICTURE	QUANTITY	PIECE	DESCRIPTION	PICTURE	QUANTITY
A	Lamp Body		1X	H	Canopy		1X
B	Bulb		6X	I	Mounting Plate 100 mmL x 20 mmW		1X
C	Fixture Loop		1X	J	Mounting Screw 4 mmD x 26 mmL		2X
D	Closable Link		5X	K	Wire Nut		3X
E	Chain		1X	L	Loop Assembly		1X
F	Canopy Nut		1X	M	Connecting Rod		3X
G	Hanging Loop		1X				

Product Dimensions:

26.25"L X 26.25"W X 30.5-102.5"H

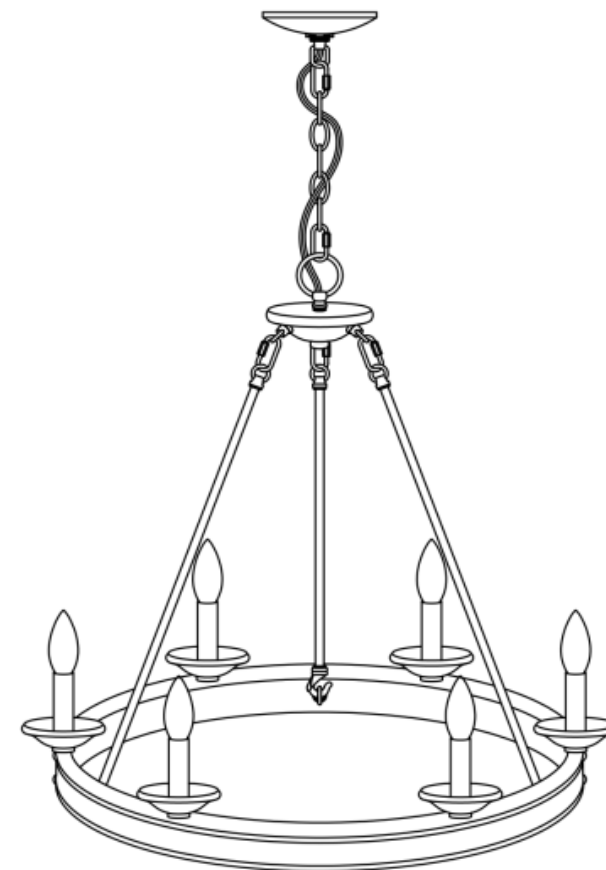

PREPARATION

- * Before beginning assembly of product, make sure all parts are present. Compare parts with package contents list and hardware contents list.
- * If any part is missing or damaged, do not attempt to assemble the product.
- * Estimated Assembly Time: 20 minutes.
- * If you are having difficulty, our friendly Customer Care team is always here to help.

NOTE: PLEASE USE TYPE "B" BULB MAX 40-WATT OR LED BULB MAX 9-WATT, THERE ARE 6PCS LED 4-WATT BULB IN THE BOX

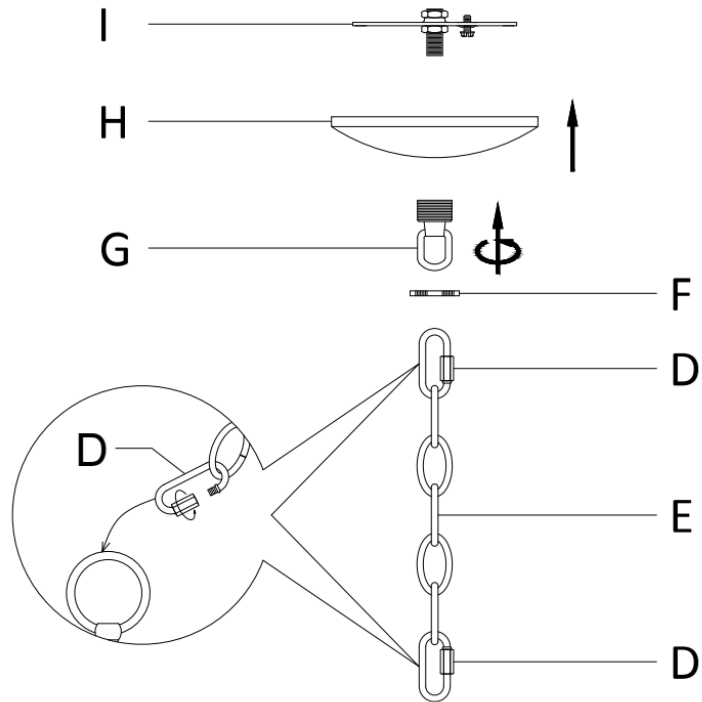

Step 1: Unpack all parts from cartons carefully. Place the Canopy(H) onto the Hanging Loop(G), Place the tube of Mounting Plate(I) into the threaded portion of the Hanging Loop(G) and fix it by turning the Canopy, Nut(F) clockwise till tight. Attach the Closable Link(D) onto the Hanging Loop(G)

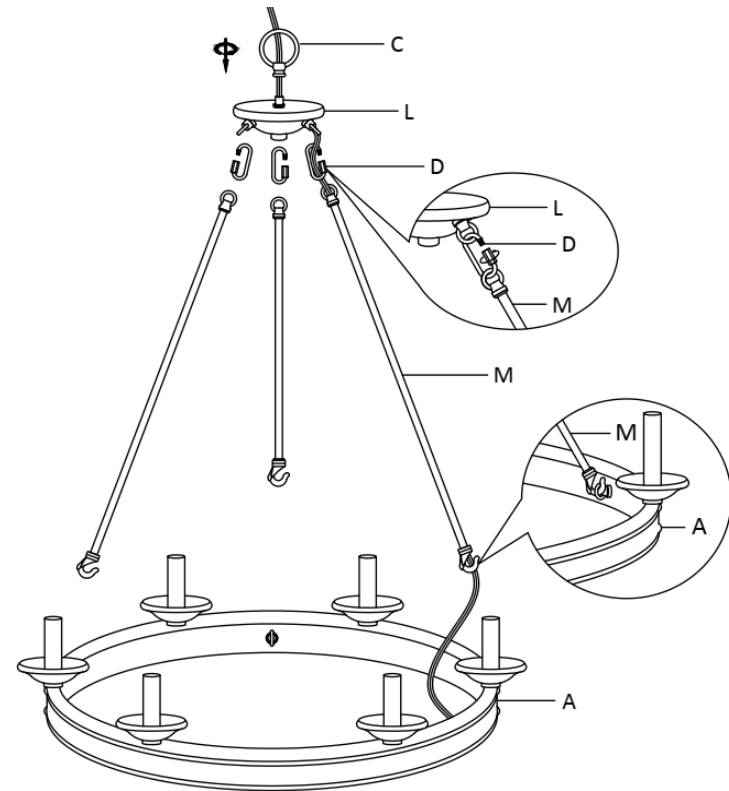

Step 2: Thread Fixture Loop (C) to Loop Assembly (L). Respectively attach the Closable Link(D) onto the loop of the Loop Assembly (L) and Connecting Rod (M), then respectively attach clip of the Loop Assembly (L) to ring of the Lamp Body (A).

PREPARATION

- * Before beginning assembly of product, make sure all parts are present. Compare parts with package contents list and hardware contents list.
- * If any part is missing or damaged, do not attempt to assemble the product.
- * Estimated Assembly Time: 20 minutes.
- * If you are having difficulty, our friendly Customer Care team is always here to help.

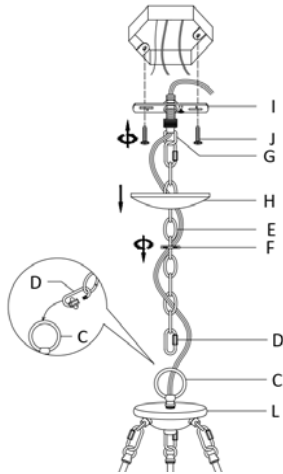

Step 3: Use Closable Link (D) attach the Chain (E) end onto the Fixture Loop (C). Separate the Mounting Plate (I) from the Canopy (H) by turning the Canopy Nut (F) anti-clockwise. Install the Mounting Plate (I) to the junction box with Mounting Screw (J). Gently cord and ground wire through Canopy Nut (F) and Canopy (H), then through Chain (E) about every third link. Next, carefully thread cord and ground wire through hole in Canopy Loop (G) and pull into Junction Box in preparation for electrical connection in next step. Permit cord and wire to hang freely next to Chain.

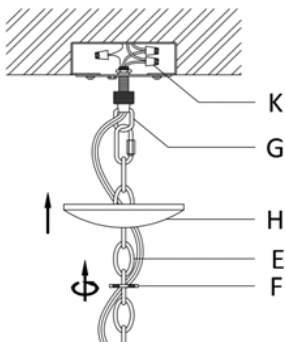

Step 5: Tuck wires inside junction box. Attach the Canopy (H) to the junction box and fix it by turning the Canopy Nut (F) clockwise.

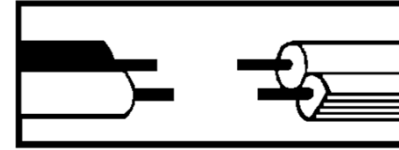

Step 4: Wire connection

Connect fixture neutral wire (ribbed) to the outlet box neutral wire (usually white) using a wire connector (K).

Connect fixture hot wire (smooth with markings) to the outlet box hot wire (usually black) using a wire connector (K).

CAUTION: Do not reverse the hot and neutral connections

Grounding Instructions:

Wrap ground wire from outlet box around green ground screw on mounting bracket, no less than 2" from wire end. Tighten ground screw. If fixture is supplied with a ground wire, connect to outlet ground wire with a wire connector (K).

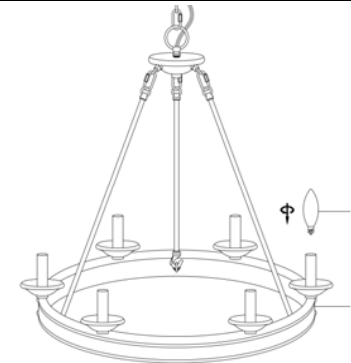

Step 6: Insert the Bulbs (B) into the socket.