

ASSEMBLY INSTRUCTIONS

MODULAR SOFA

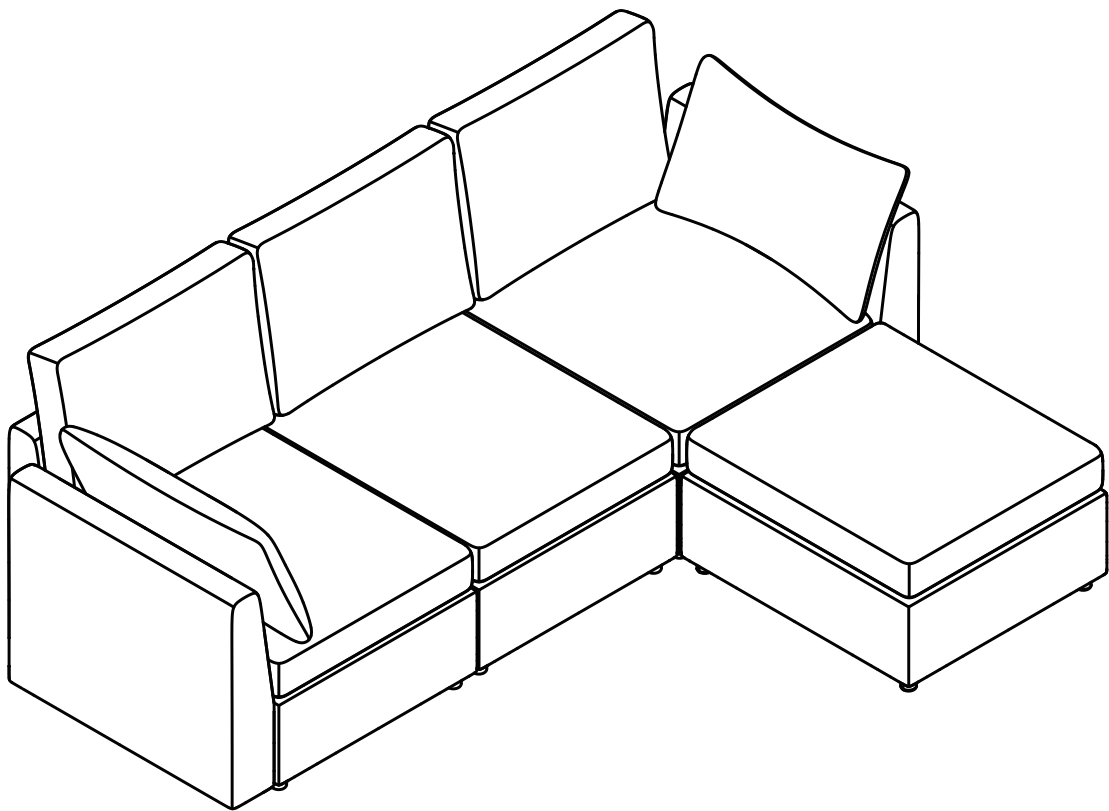

TIME



2 OF PEOPLE



DIFFICULTY

NOTICE

Instruction Booklet - Important Safety Information

Thank you for choosing our product. Please review this booklet carefully for essential safety information and keep it for future reference.

- Upon receiving the product, ***ensure all parts are present and intact*** before proceeding with installation. Follow the entire installation instructions provided.
- During installation, exercise caution and refrain from immediately tightening screws. Secure all screws to 80% before final tightening.
- The item has been divided into **2** packages. If your multi-package order does not arrive simultaneously, please allow 1-3 working days for the remaining package to arrive promptly.
- Note: Cushions are ***compressed*** and cannot be recompressed once opened. Returns are accepted only for items in their ***original, unopened condition***.



Before installation, please check that the parts are all included !

Carton A

Materials ▶

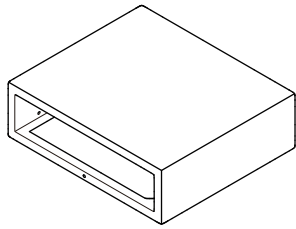

Sideling frame

D-L*1

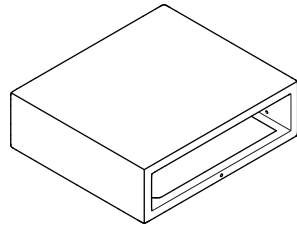

Sideling frame

F-R*1

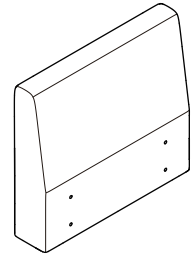

Left armrest

A*1

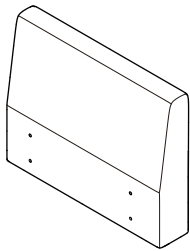

Right armrest

B*1

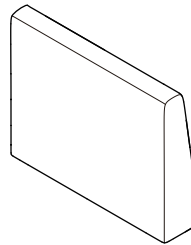

Backrest frame

C*2

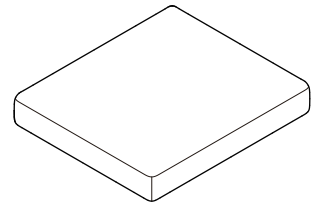

Seat cushion bag

H*2

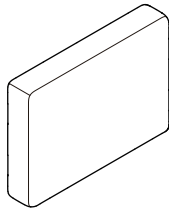

Back cushion

I*2

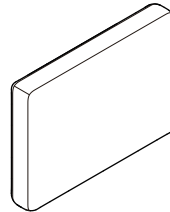

Armrest pillow

J*2

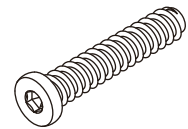

M8*50

Screw

L*16

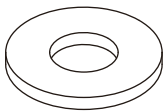

washer

M*18

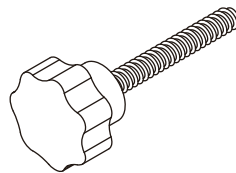

M8*90

Screw

N*1

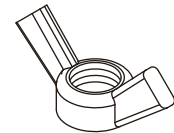

Nut

O*1

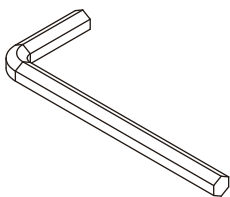

Wrench

P*1

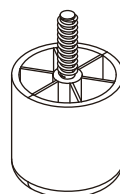

Leg

K*8

Carton B

Materials ▶

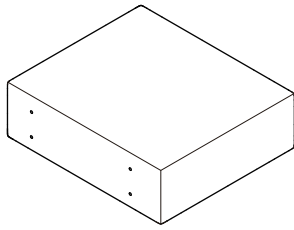

Intermediate seat frame **E*1**

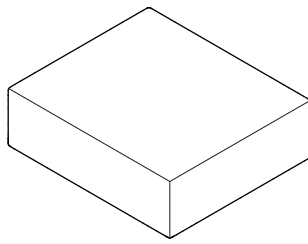

Footstool seat frame **G*1**

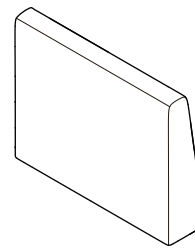

Center backrest frame **C*1**

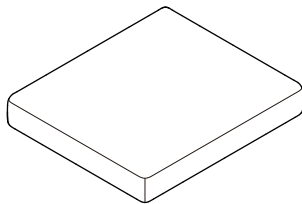

Seat cushion bag **H*2**

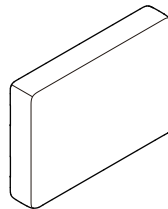

Back cushion **I*1**

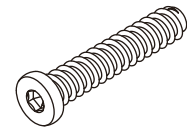

M8*50

Screw **L*4**

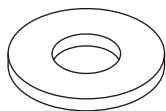

washer **M*6**

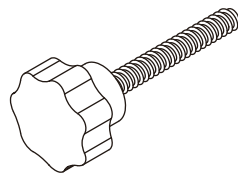

M8*90

Screw **N*1**

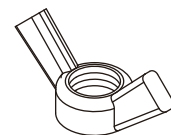

Nut **O*1**

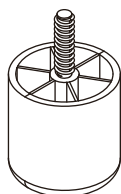

Leg **K*8**

Installation Steps

Materials ▶

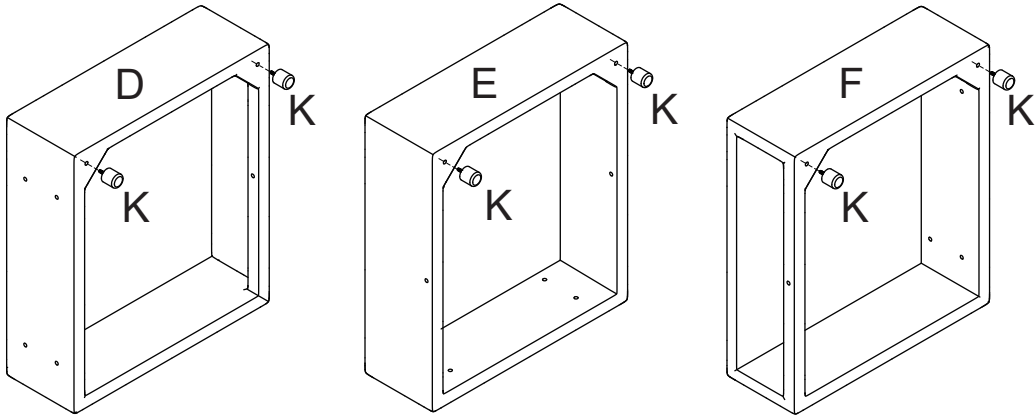

STEP 1

Install K on the D, E, and F frames.

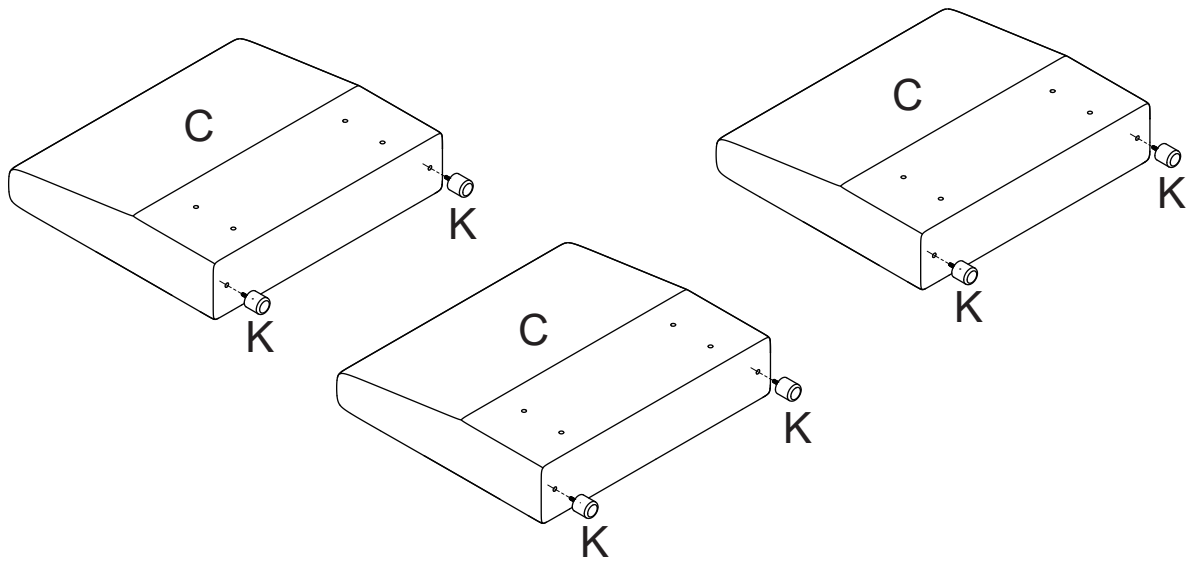

STEP 2

Install K on each of the three C backrests.

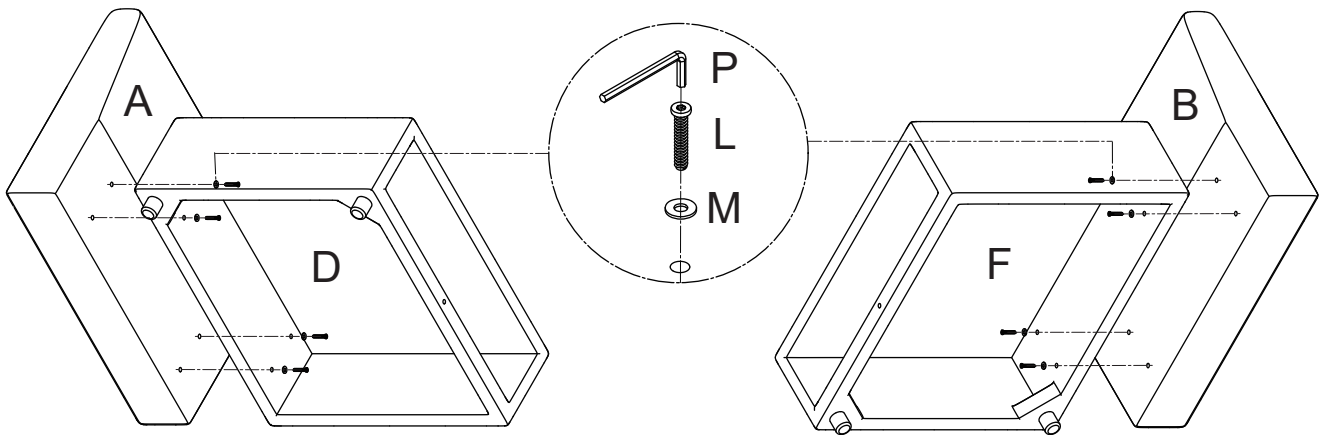

STEP 3

Slip M over L using P to connect A to D and B to F.

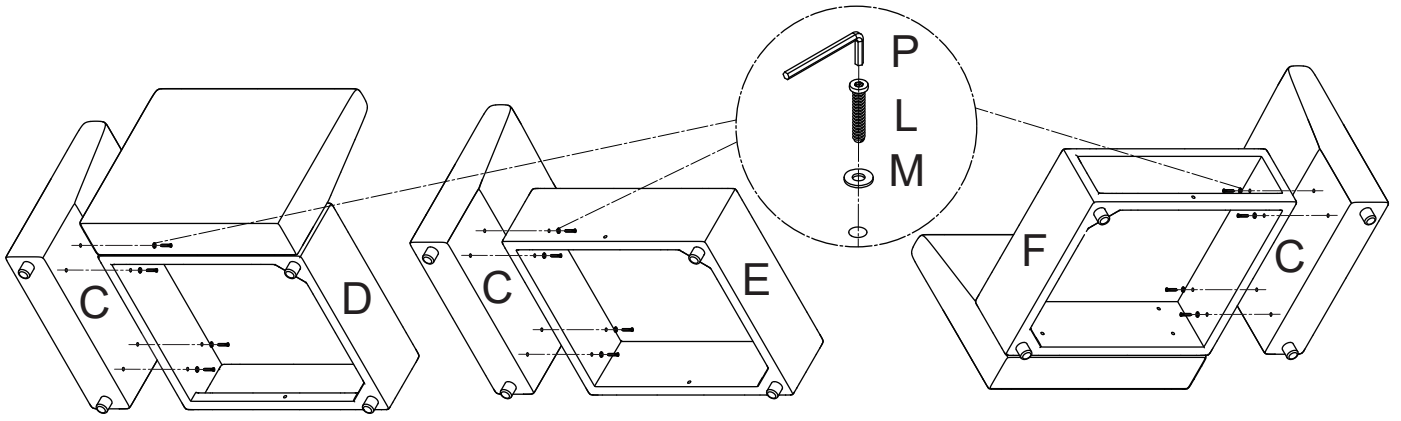

STEP 4

Slip M over L using P to connect the three C's to D, E, and F.

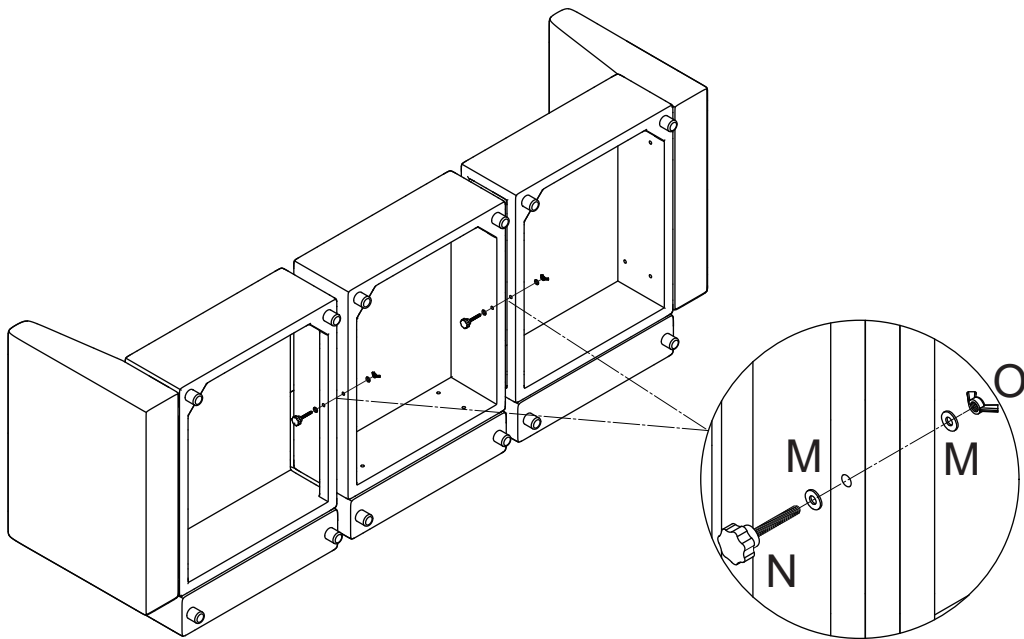

STEP 5

Slip M over N through the connection holes of the two frames, then slip another M over it, and secure it with O hardware.

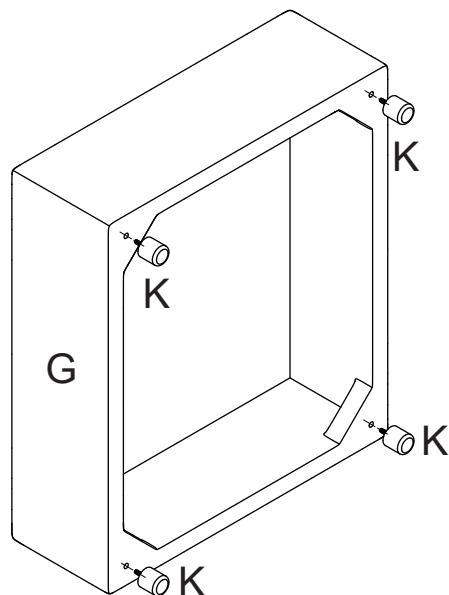

Install K on G.

STEP 6

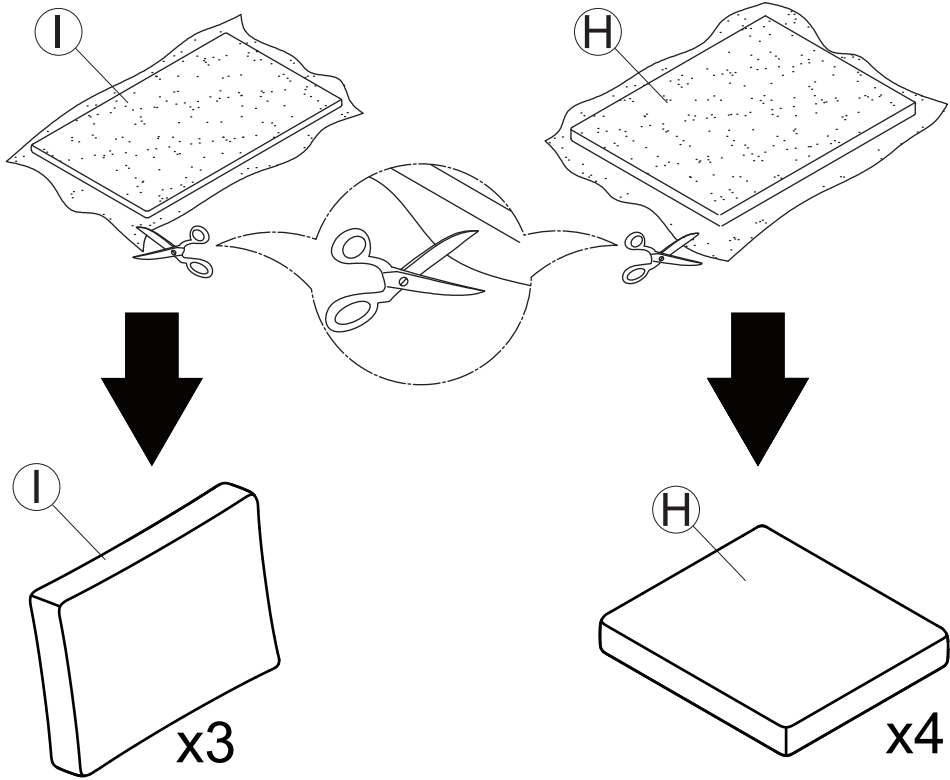

Open I and H compression bags, shake them to fluff them up and let them sit for at least 24 hours until the bags fully recover.

STEP 7

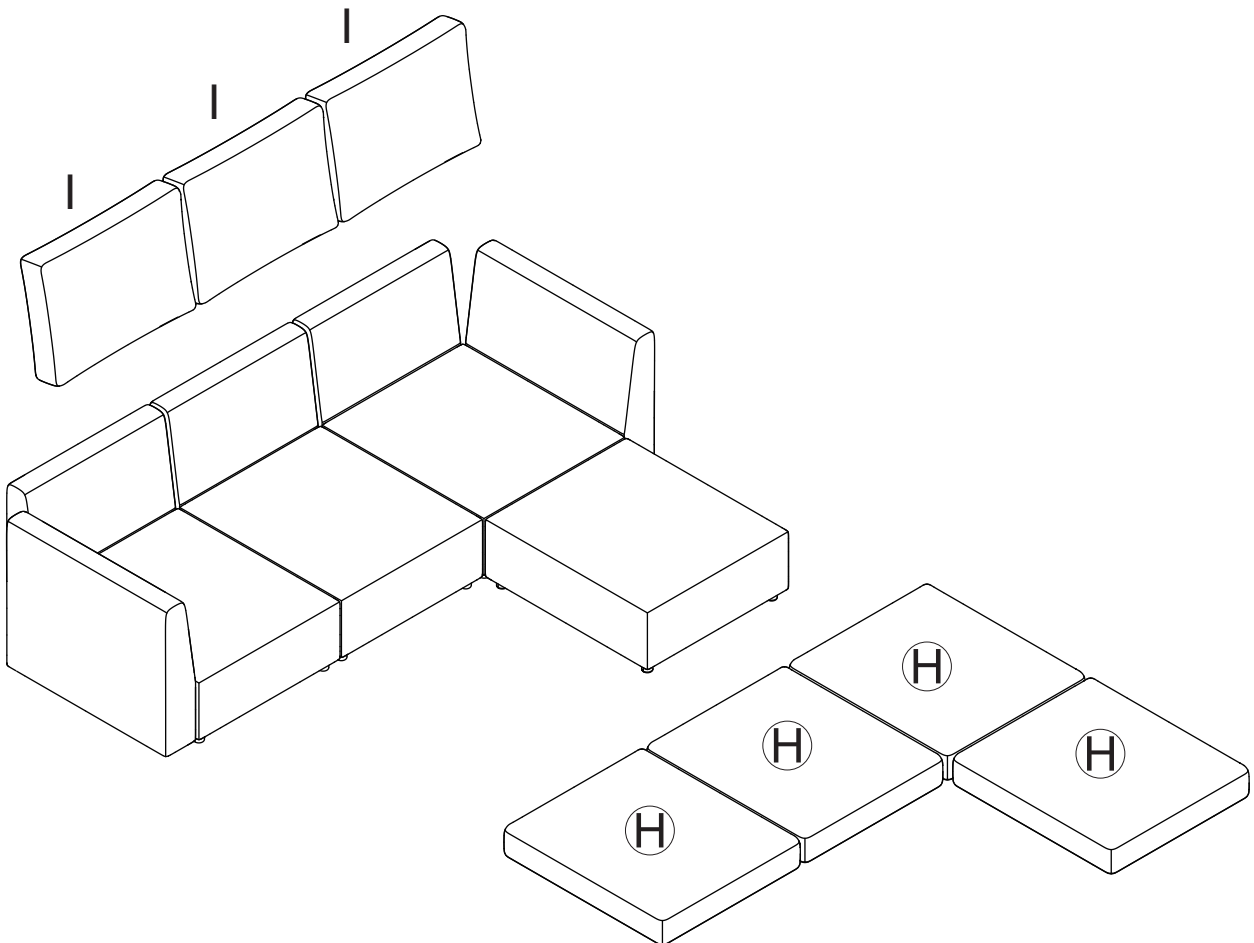

Place I and H on the sofa.

STEP 8

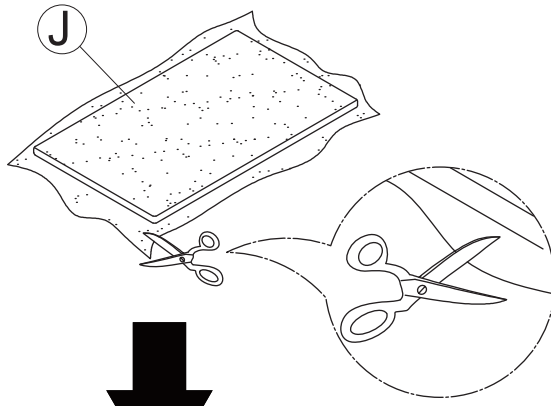

Open J compression bag, shake it to fluff it up and let it sit for at least 24 hours until the bag fully recovers.

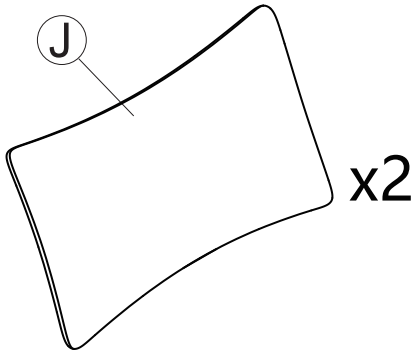

STEP 9

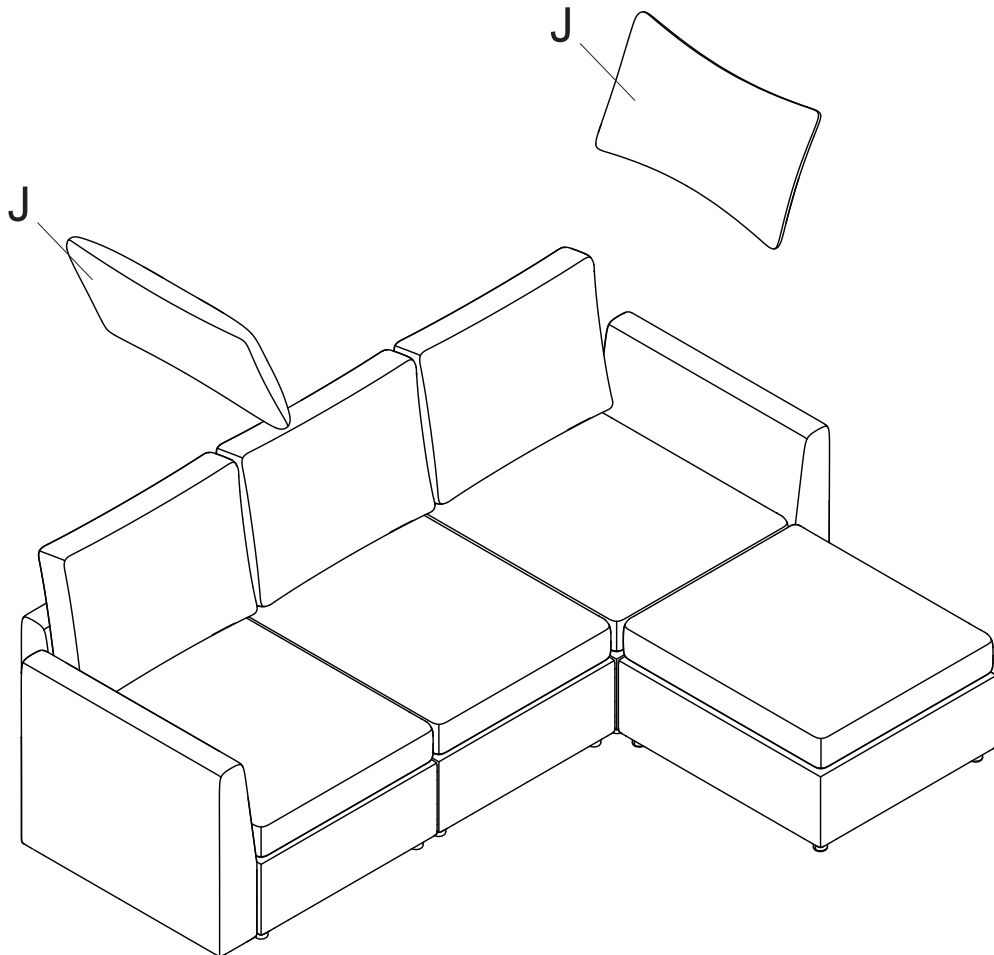

STEP 10

Place J on the sofa.

Care

Instructions

Your furniture, when treated with care and affection, will endure for years to come. Each piece demands gentle upkeep to enhance daily comfort and extend its lifespan. Just like any cherished possession, when treated kindly, it reciprocates that kindness. Your furniture is crafted to support you and bring joy into your life, enriching your home and your experiences.

1. Place the sofa away from direct sunlight, or utilize curtains or blinds to minimize exposure.

2. Regularly clean the sofa with a dry, soft cloth or a vacuum equipped with a gentle attachment.

3. Address stubborn stains promptly by blotting the affected area with a soft cloth soaked in warm water and mild soap. Follow up by drying with a clean cloth.

4. Avoid excessive rubbing during cleaning, as it may damage the weave and cause discoloration.

5. We recommend affixing felt pads underneath the sofa to prevent floor scratches. Additionally, laying a rug beneath can provide both protection and aesthetic appeal to your living space.

6. Ensure even weight distribution on the cushions regularly for optimal care.

By adhering to these care instructions, your furniture will continue to serve you well in return. We look forward to welcoming you back soon!

Frequently Asked Questions

We understand that receiving damaged or defective products can be disappointing, and we're here to assist you every step of the way. Here's how to address common concerns and initiate a damage claim:

1.What should I do if my shipment is damaged or products received are defective?

We're genuinely sorry to hear about any inconvenience caused. Please reach out to us promptly, and our team will prioritize resolving the matter swiftly and effectively. To file a damage claim, follow these steps:

- A. Retain the original box in case a return is required.
- B. Take photos of the damaged box, the damaged part of the item, tracking number, and return label on the box to help us process a replacement or refund.

2.Can I return the product if I'm not satisfied?

While we uphold stringent quality standards and collaborate with experienced manufacturers, we acknowledge that dissatisfaction may arise. If you're still unsatisfied, you can initiate a return within 30 days of receiving the product. Simply message us with your reasons for return, and we'll facilitate the process.