

# Assembly Instruction

---

## Coffee table

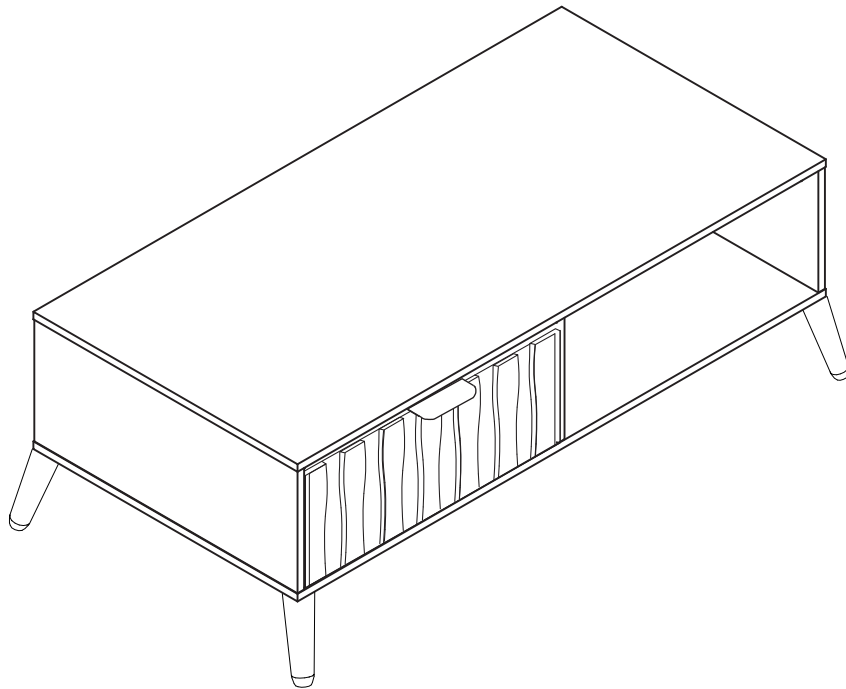

---

### ASSEMBLY TIPS:

1. Remove hardware from box and sort by size.
2. Please check to see that all hardware and parts are present prior to start of assembly.
3. Please follow attached instructions in the same sequence as numbered to assure fast & easy assembly.



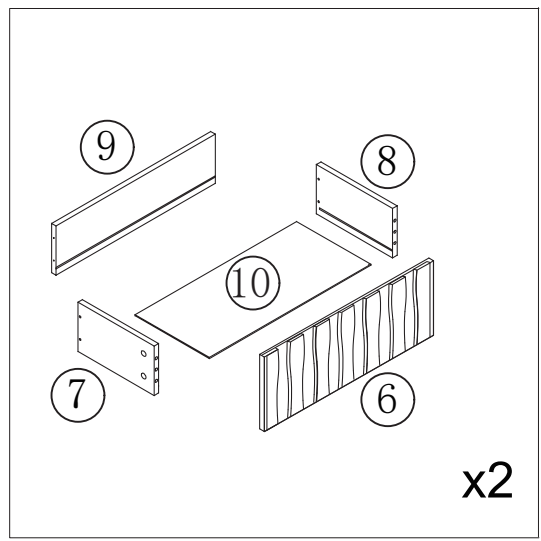
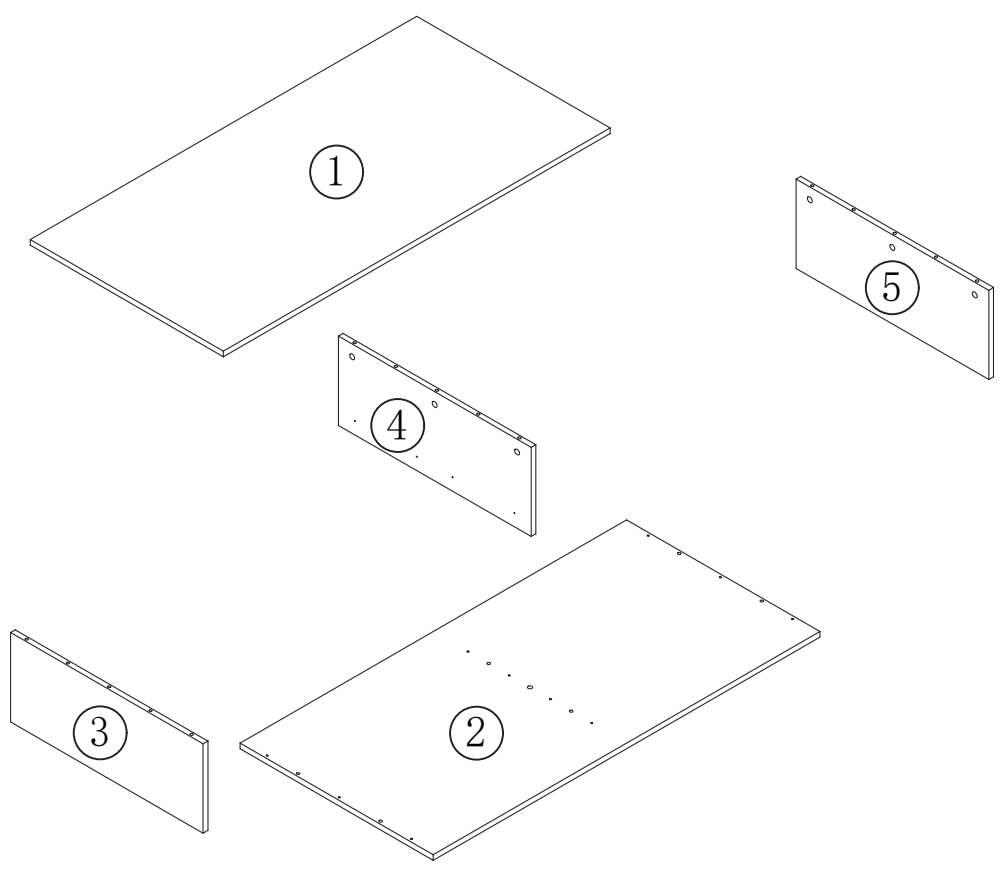



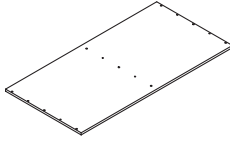
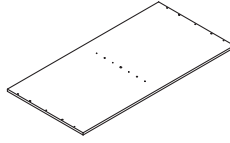
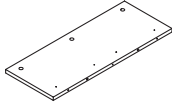
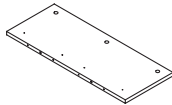
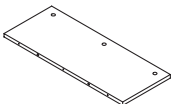
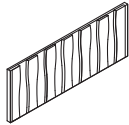
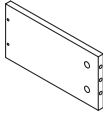
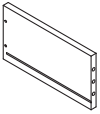
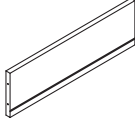
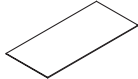



# Parts List

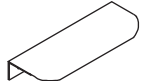
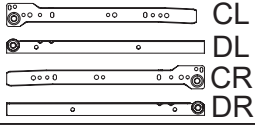

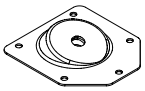
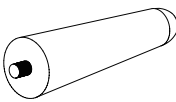
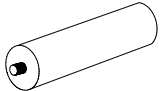
# Parts List

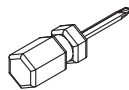

Number	Name	Part	Qty
1	Table top panel		x1PC
2	Base plate		x1PC
3	Left side panel		x1PC
4	Neutral plate		x1PC
5	Right side panel		x1PC
6	Drawer panel		x2PC
7	Left side of the chest cavity		x2PC
8	Right side of the chest cavity		x2PC
9	Drawer back panel		x2PC
10	Drawer bottom plate		x2PC

# Hardware List

Number	Hardware	Part	Qty
A	6X40 15X11.5		x17+1PCS
B	8x30		x16+1PCS
C			x2PCS
D	L250	 CL DL CR DR	x2PCS
E	3.5*35		x8+1PCS
F	3.5x14		x40+1PCS
G			x4PCS
H			x4PCS
I			x1PCS
J	5x40		x10+1PCS
K			x1PCS
L			x1PCS
M	M15		x5PCS
N	M20		x17+1PCS

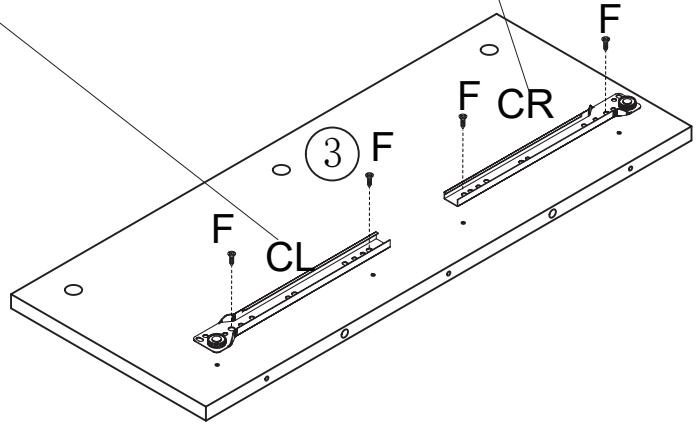
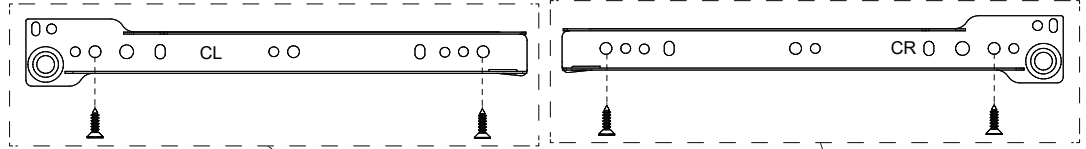
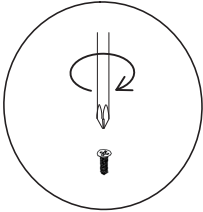

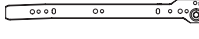
# 1

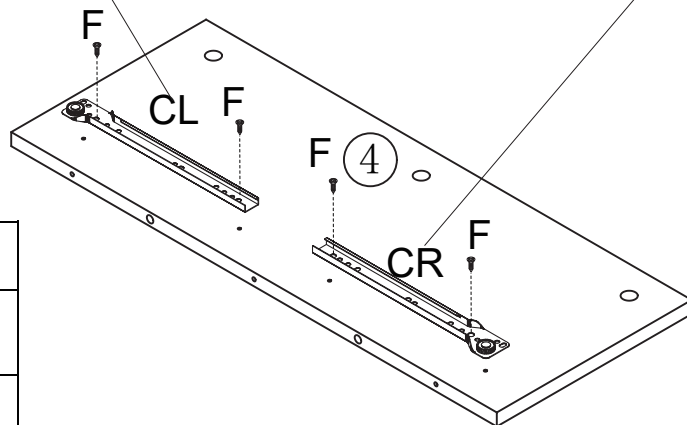
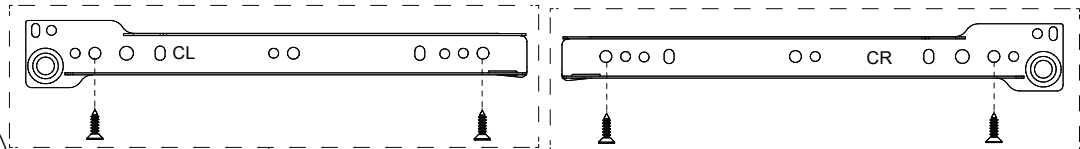
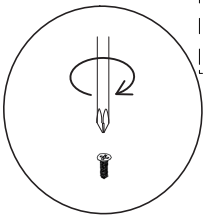

YOU WILL NEED		
CL		x1
CR		x1
F		x4

# 2



YOU WILL NEED		
CL		x1
CR		x1
F		x4

3

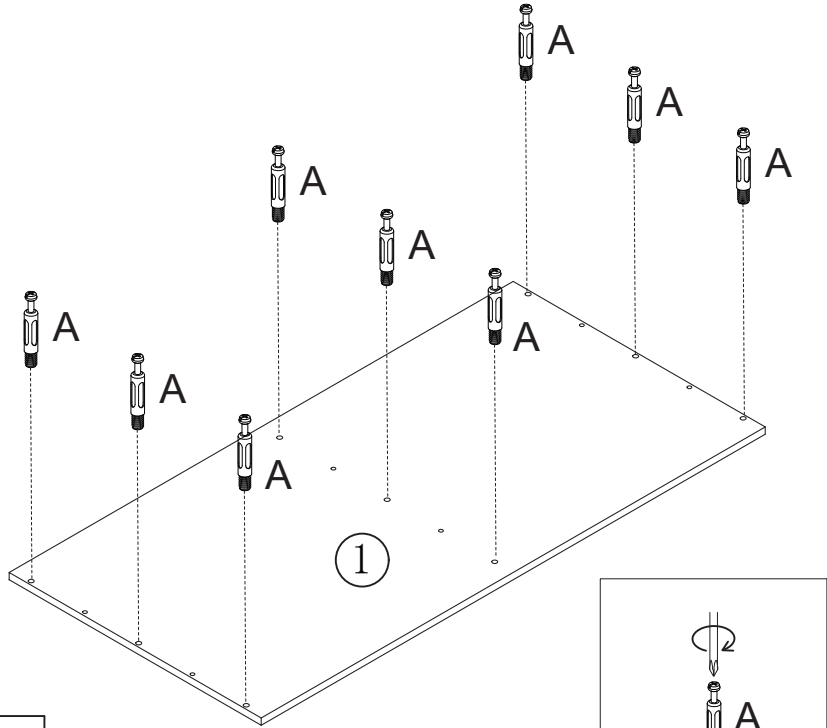



YOU WILL NEED

A		x9
---	--	----

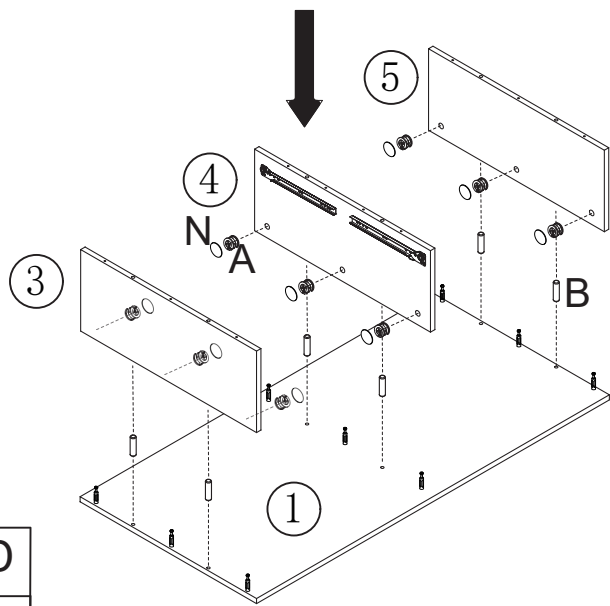
4



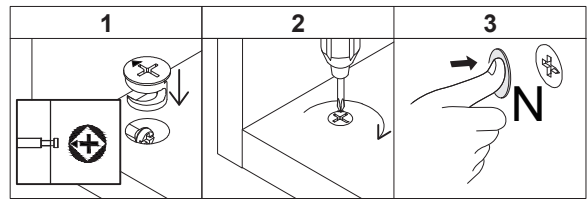

YOU WILL NEED

A		x9
B		x6
N		x9



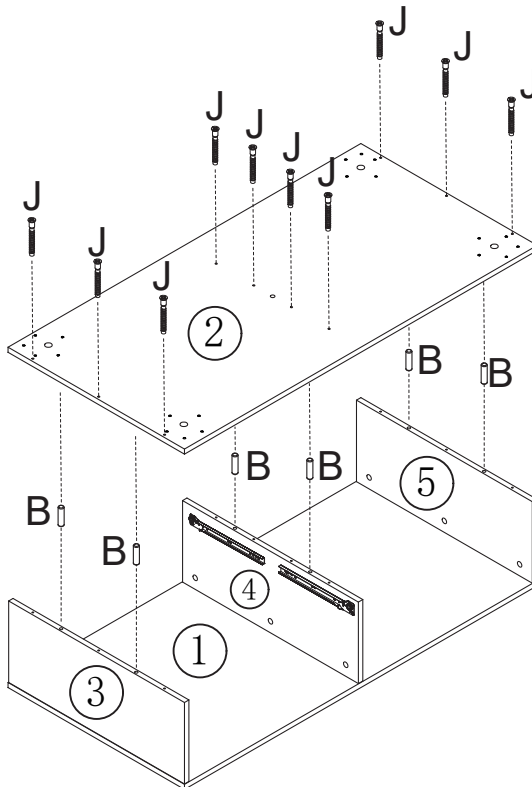





5

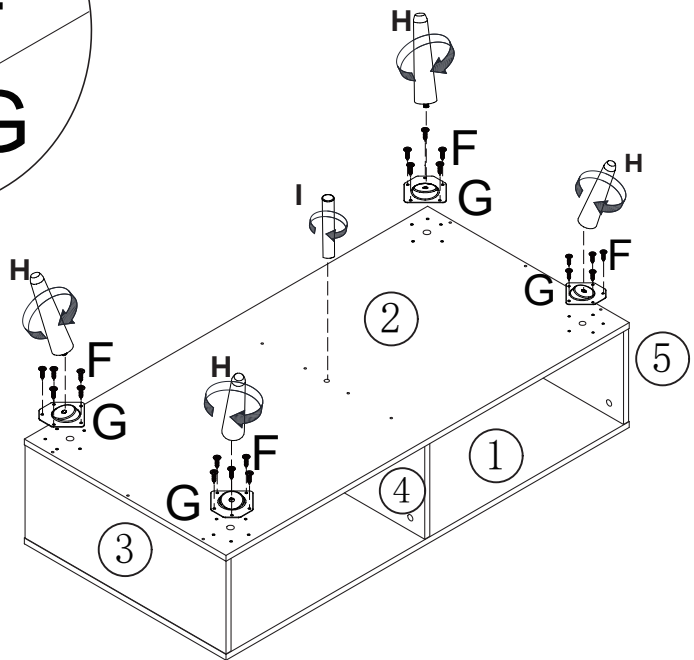
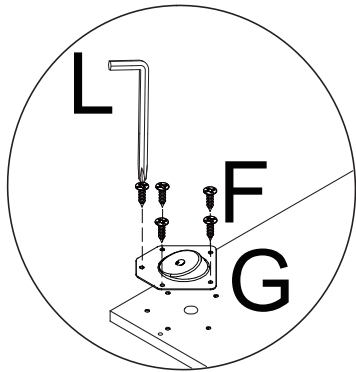

YOU WILL NEED		
B		x6
J		x10

6



YOU WILL NEED		
H		x4
I		x1
F		x20
G		x4
L		x1

7

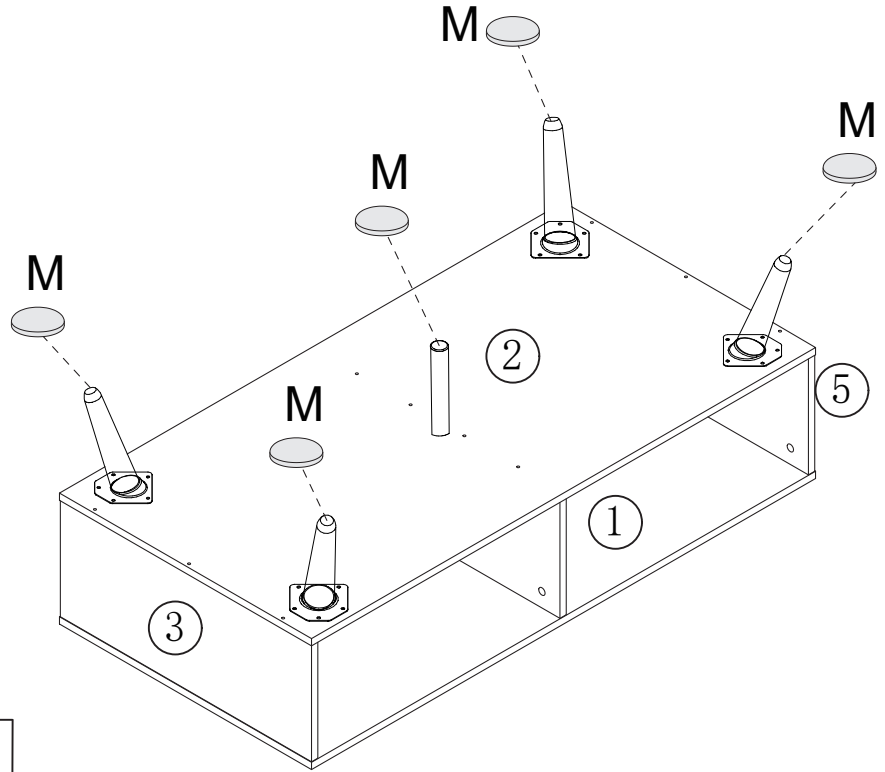

YOU WILL NEED		
M		x5

8

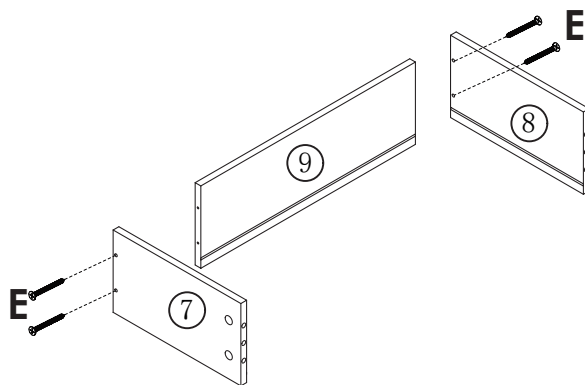

YOU WILL NEED		
E		x8

x2

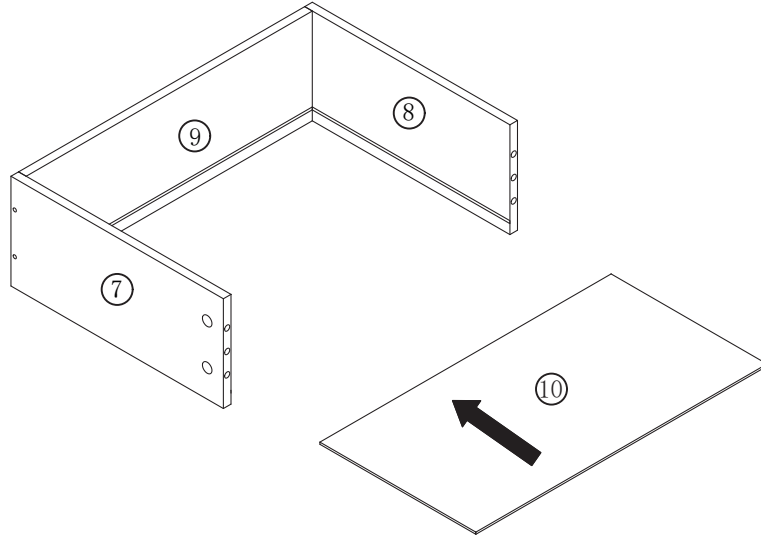

9

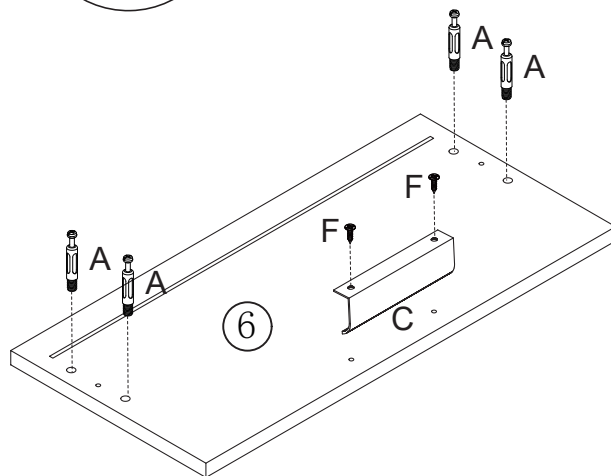
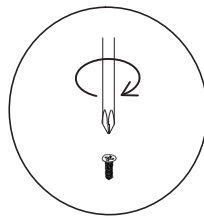
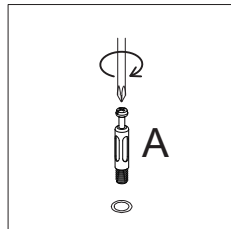

x2

10

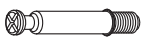





YOU WILL NEED		
A		x8
C		x2
F		x4

x2

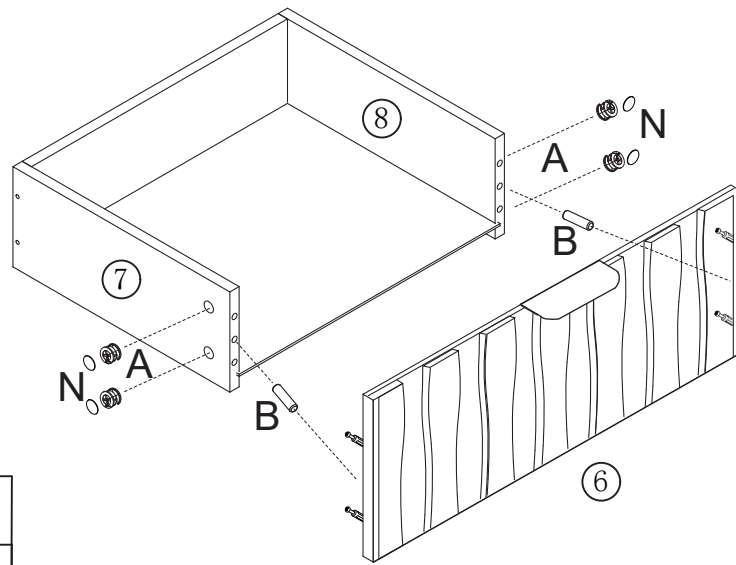
# 11

x2



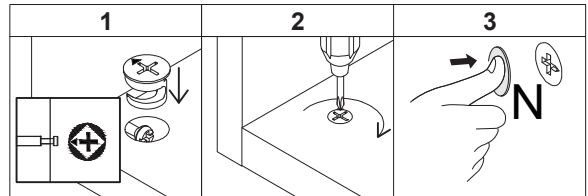

YOU WILL NEED		
A		x8
B		x4
N		x8

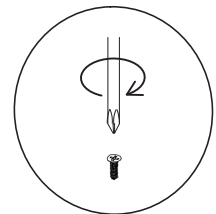
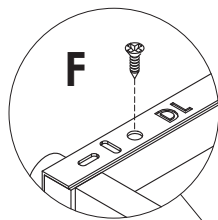

# 12

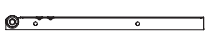
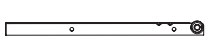

YOU WILL NEED		
DL		x2
DR		x2
F		x8

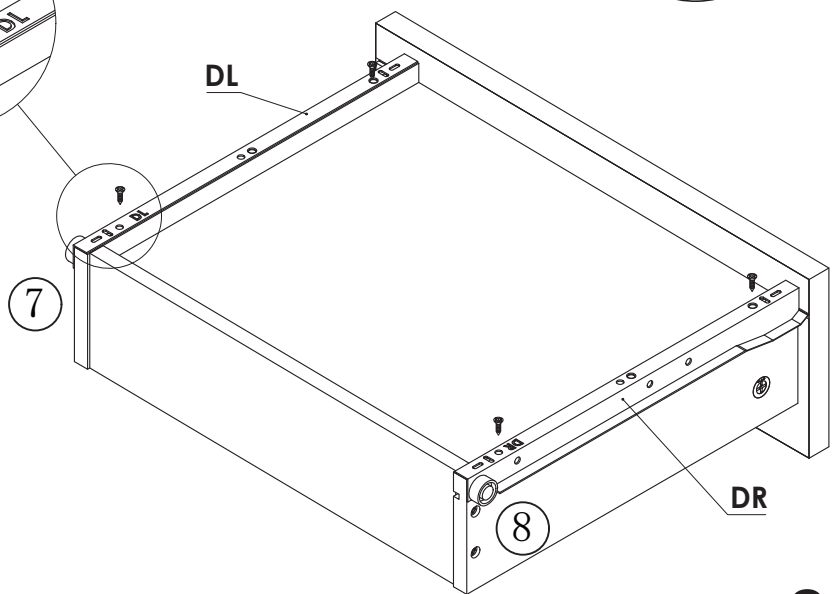

x2

13

