







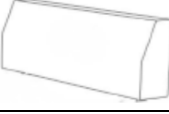
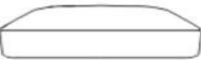

ASSEMBLY INSTRUCTIONS

ELLINGTON U-SECTIONAL

Avoid using sharp objects such as a knife to cut open packaging, as you may accidentally damage the upholstery.

PARTS LIST

| ITEM | DESCRIPTION | SKETCH | QUANTITY |
|------|--------------------------|--|----------|
| 1 | LEGS |  | 24x |
| 2 | SEAT DECK / OTTOMAN BASE |  | 6x |
| 3 | BACKREST |  | 4x |
| 4 | ARM REST |  | 2x |
| 5 | SEAT CUSHION |  | 4x |
| 6 | BACK CUSHION |  | 4x |
| 7 | ARM CUSHION |  | 2x |
| 8 | OTTOMAN CUSHION |  | 2x |
| A | BRACKETS |  | 12x |
| B | FELT PADS |  | 24x |

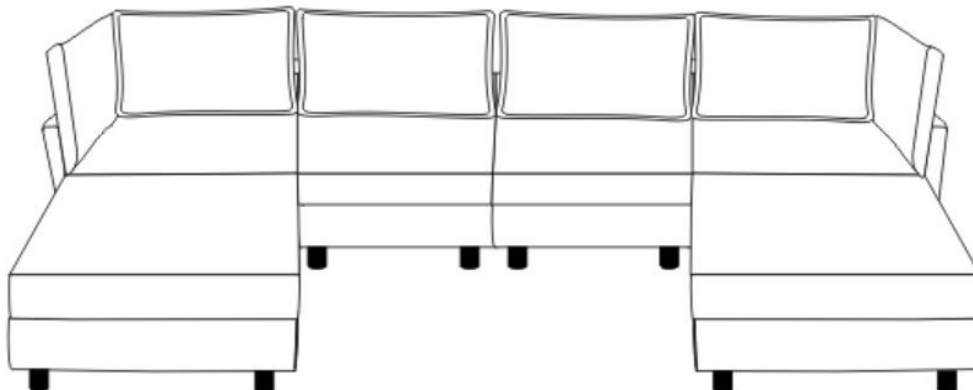

STEP 1: Flip over the **Seat Deck/Ottoman Base (2)** to see woven fabric with Velcro closure. Cut the black strap and remove parts for assembly.

Please allow up to 24 hours for the cushions to recover to their natural state after removal from packaging.

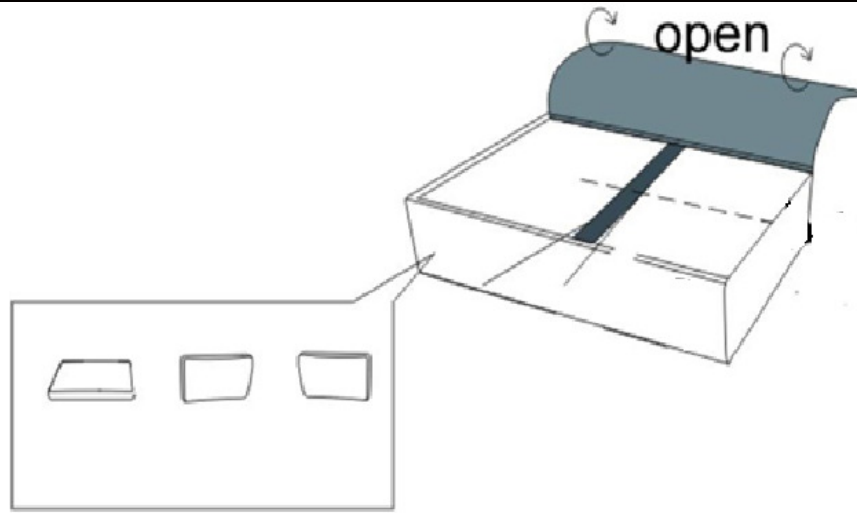

STEP 2: Attach **Legs (1)** to **Seat Deck (2)** by hand turning until tight. Then stick 4 pieces of the **Felt Pads (B)** to the bottom of the **Legs (1)**.

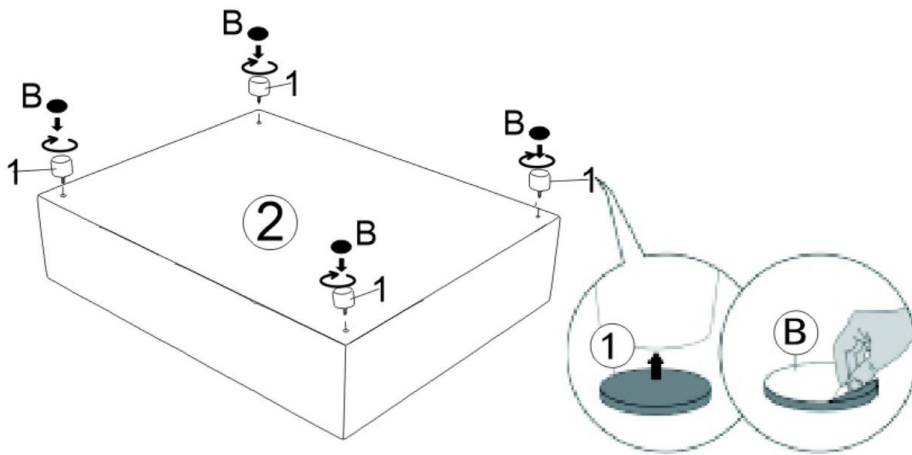

STEP 3: On the bottom of the **Seat Deck (2)** there is Velcro to connect the seats together as shown below.

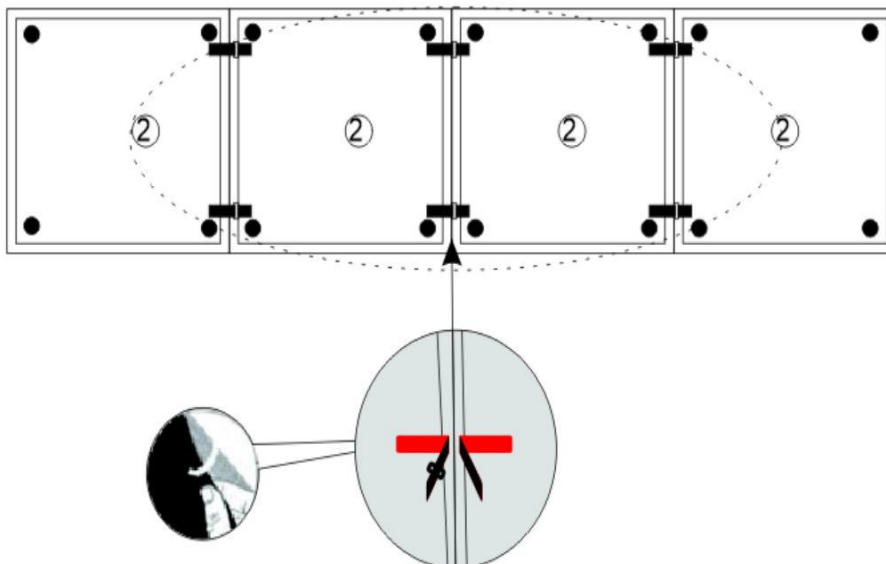

STEP 4: Insert **Brackets (A)** into **Backrest (3)** and **Arms (4)**. Attach **Backrest (3)** to **Seat Deck (2)** by sliding the brackets on **Backrest (A)** into the glides on **Seat Deck (2)**.

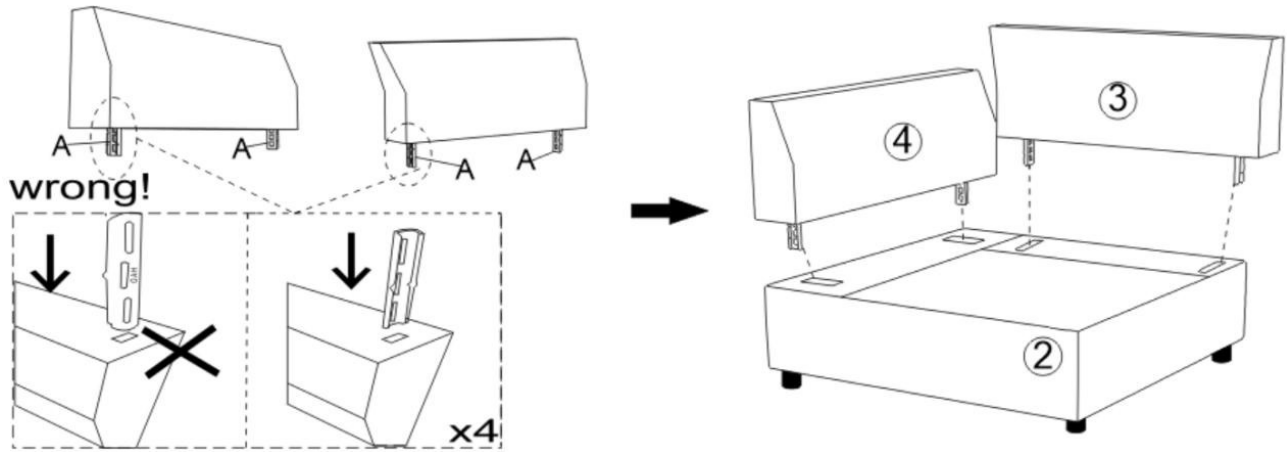
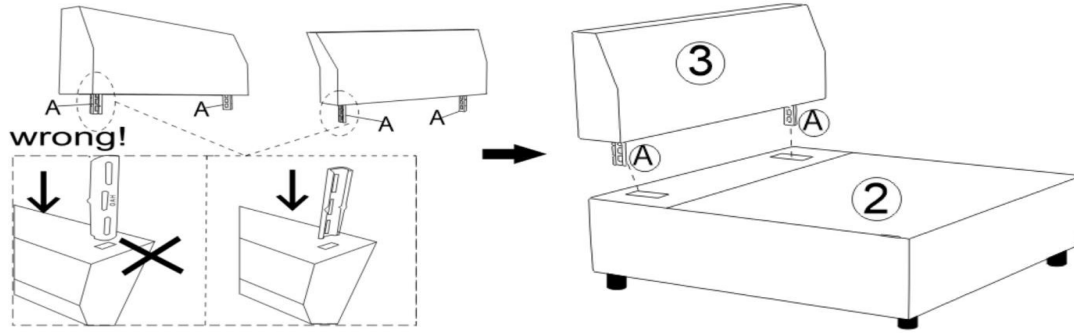

STEP 5: Remove the black cover tape from the Velcro before placing the cushion on top. Carefully put **Seat Cushion (5)**, **Back Cushion (6)**, **Arm Cushion (7)** and **Ottoman Cushion (8)** to the assembled **Sofa Seat/Ottoman (2)** and **Sofa Back (3)** and **Arm Back (4)** as shown.

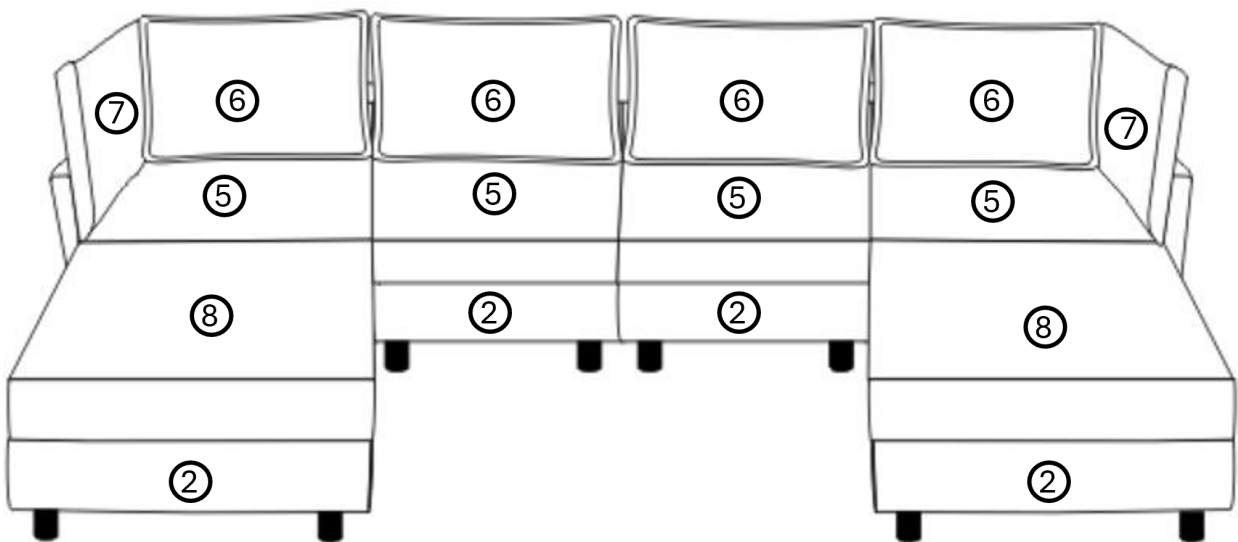

STEP 6: Enjoy your new sofa.

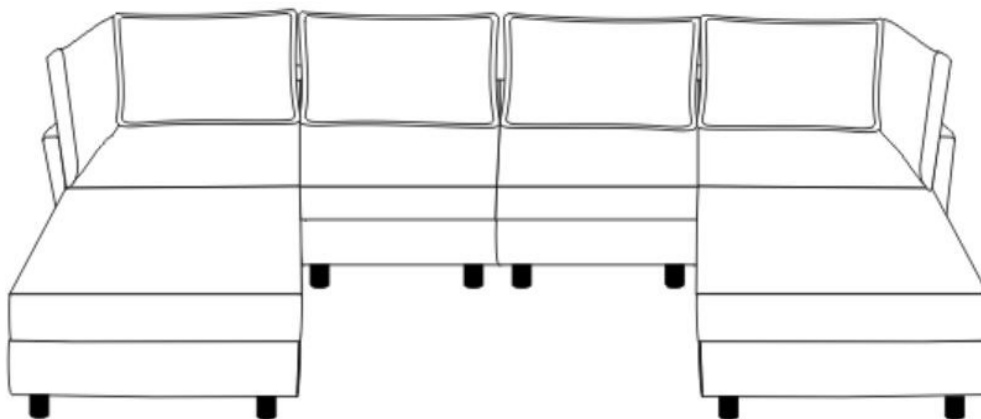

CLEANING INSTRUCTIONS: Clean with a Soft cloth, brush, or lightly vacuum

ADULT ASSEMBLY REQUIRED / REQUIERE MONTAJE POR ADULTOS

If you are missing any parts or have any questions regarding assembly, do not return this item to the retailer's store. Please call our toll-free, customer service number and have this assembly manual open to the parts list ready to provide the model name, number and part name or number.

Customer Service

1-877-864-5752

8:30 AM PST - 4:00 PM PST (Monday-Friday)

Website: www.dwellhom.com

Missing Parts: parts@dwellhom.com

Warranty Information: www.dwellhom.com/warranty



WARNING: This product may contain small components, please ensure they are kept away from small children.