















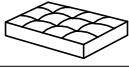



ASSEMBLY INSTRUCTIONS

Caution: Please read instructions thoroughly before unpacking assembly parts. Sharp, exposed staple tips can cause injury, therefore, for your protection, please remove any exposed staple used in packing.

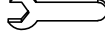
1. We recommend that you should assemble this product with the assistance of another person; this will make assembly easier, and will help to eliminate damage to the product or injury to persons during assembly.
2. Be sure to check all packing materials carefully for small parts that may have come loose inside the carton during shipment.
3. please do not over tighten screws or bolts until the assembly is complete.
4. Please put all parts on a non-abrasive floor before assembly, and follow the assembly steps to assemble your newly purchased product correctly and efficiently.

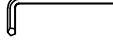
PARTS LIST			
NO	DESCRIPTION	DRAWING	QTY
A1	Backrest		2 Pcs
A2	Backrest Console		1 Pc
A3	Armrest Left		1 Pc
A4	Armrest Right		1 Pc
A5	Laf Frame		1 Pc
A6	Raf Frame		1 Pc
A7	Console Frame		1 Pc
A8	Seat cushion		2 Pcs
A9	Back cushion		2 Pcs
A10	Pillow		2 Pcs
A11	Leg		4 Pcs
A12	Wood Leg		4 Pcs
A13	Adapter		2 Pcs

HARDWARE				
NO	DESCRIPTION	SKETCH	SIZE	QTY
①	Thread Bolt		1/4 x 80 mm	8 Pcs
②	Flat Washer		1/4	8 Pcs
③	Hexnut		1/4 x 10 mm	8 Pcs
④	Wrench		10 x 90	1 Pc
⑤	Bolt		1/4 x 30 mm	8 Pcs
⑥	Allen Key		1/4	1 Pc

HARDWARE CONSOLE				
NO	DESCRIPTION	SKETCH	SIZE	QTY
⑦	Thumb Bolts		5/16 x 50 mm	2 Pcs
⑧	Flat Washer		5/16	2 Pcs

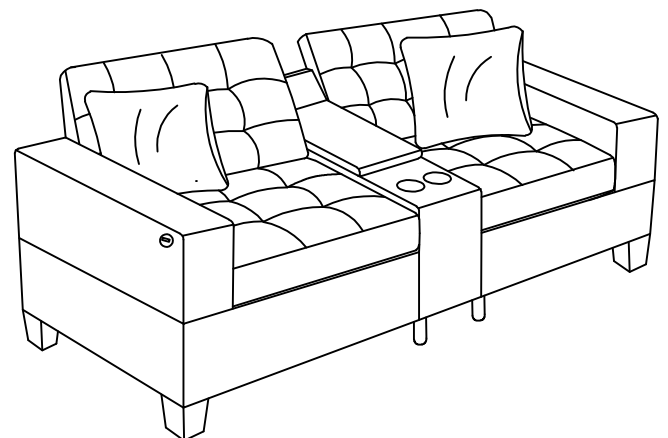

IMPORTANT NOTE

Do not use a power tool to assemble this product as it could damage the thread of the hardware and affect the solidity /durability of the product

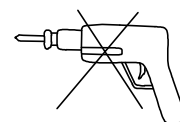

STEP 1

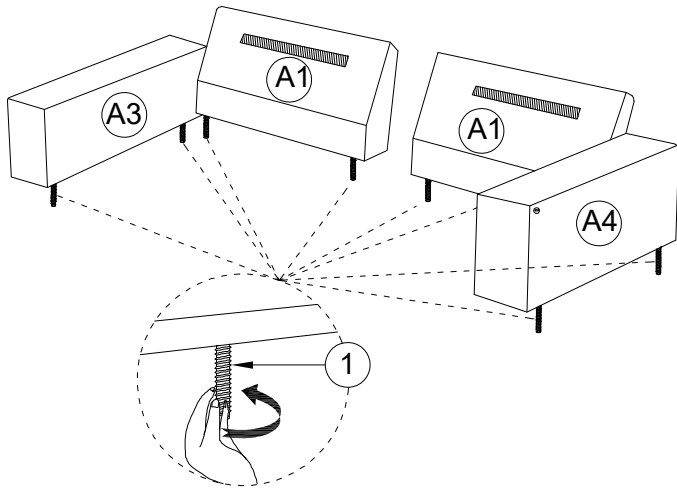

STEP 2

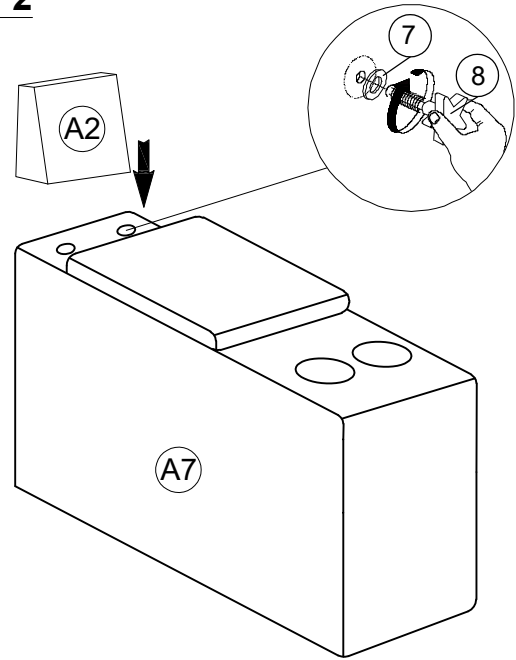

STEP 3

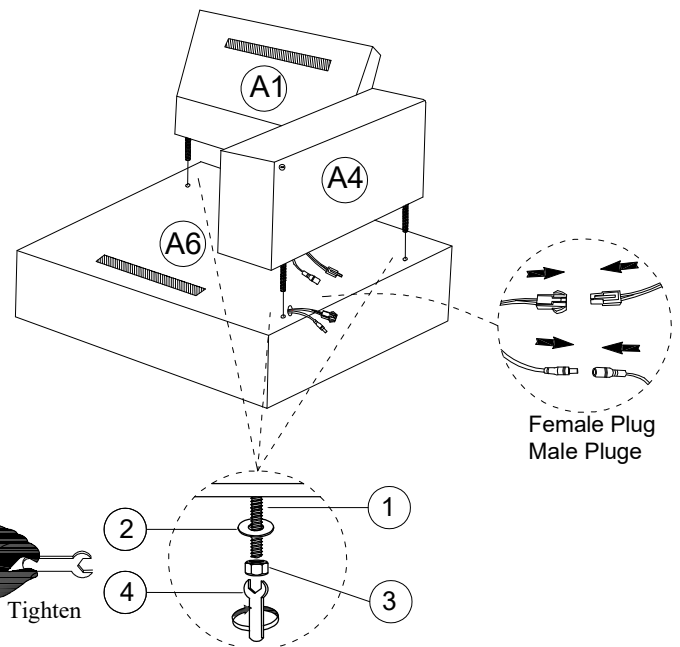
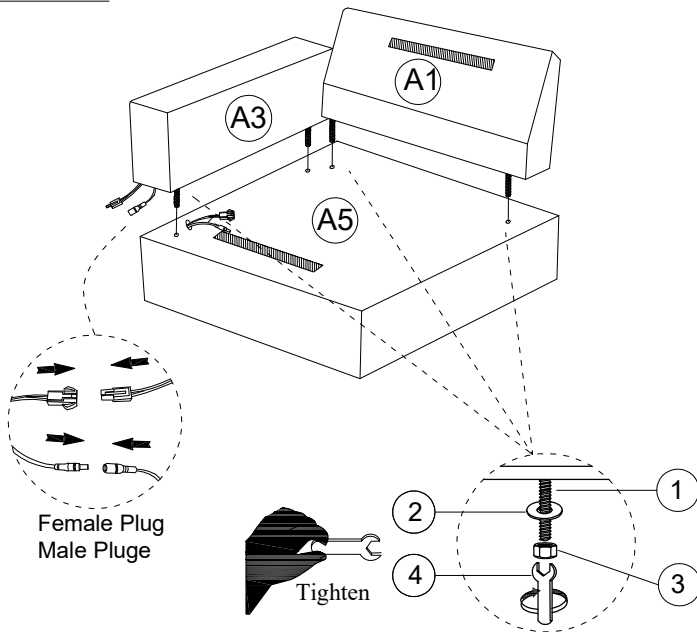

STEP 4

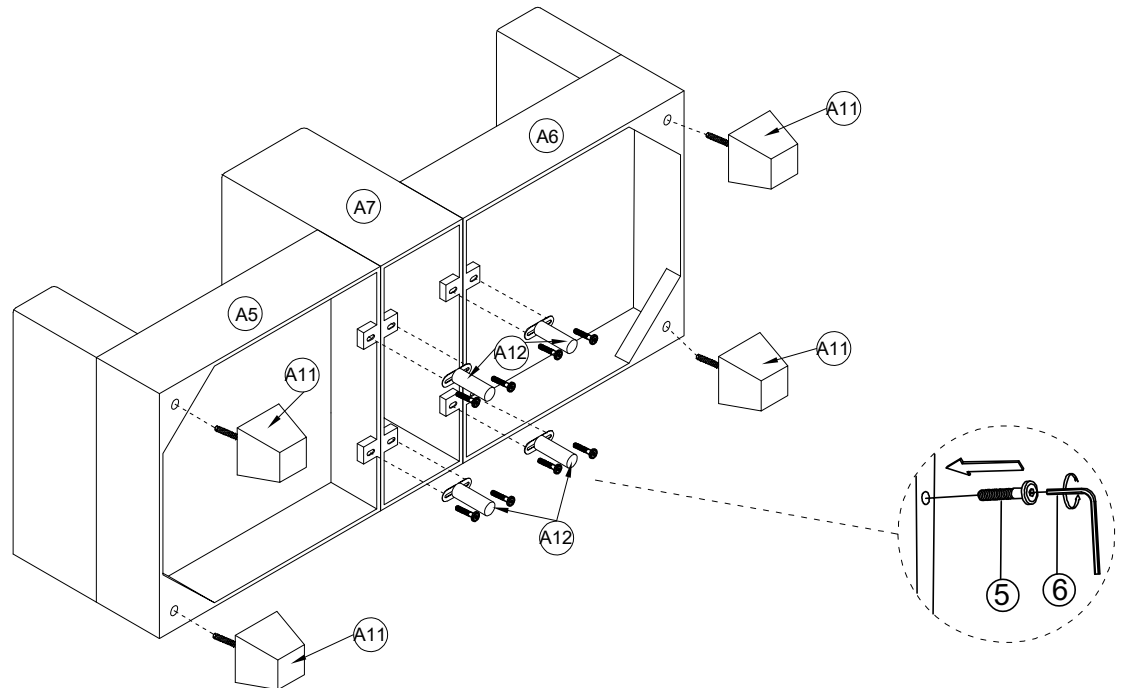

STEP 5

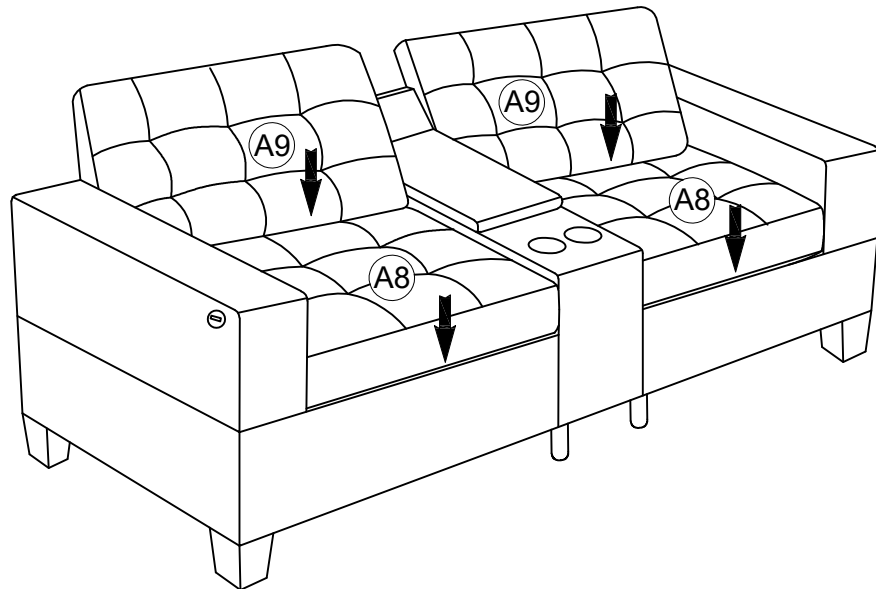

STEP 6

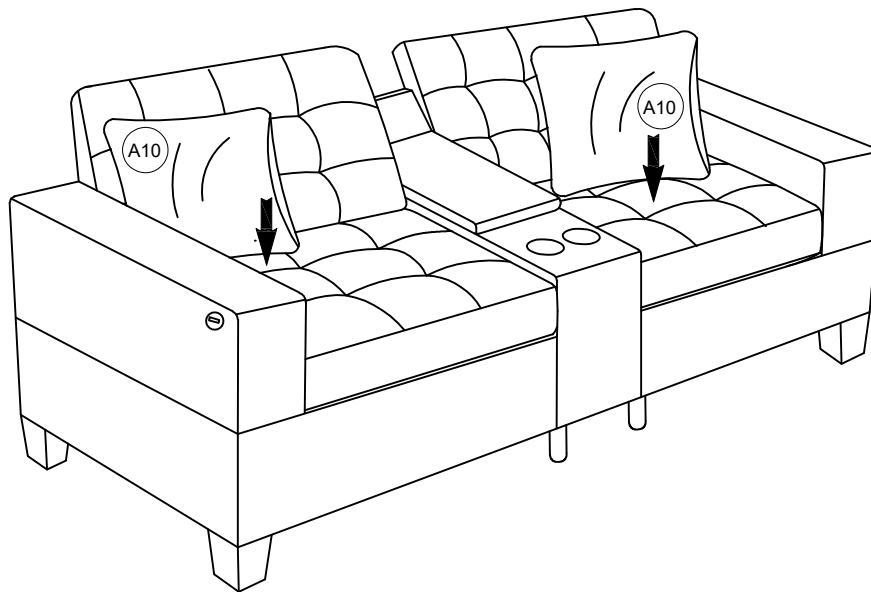

COMPLETE

