

Assembly Instructions

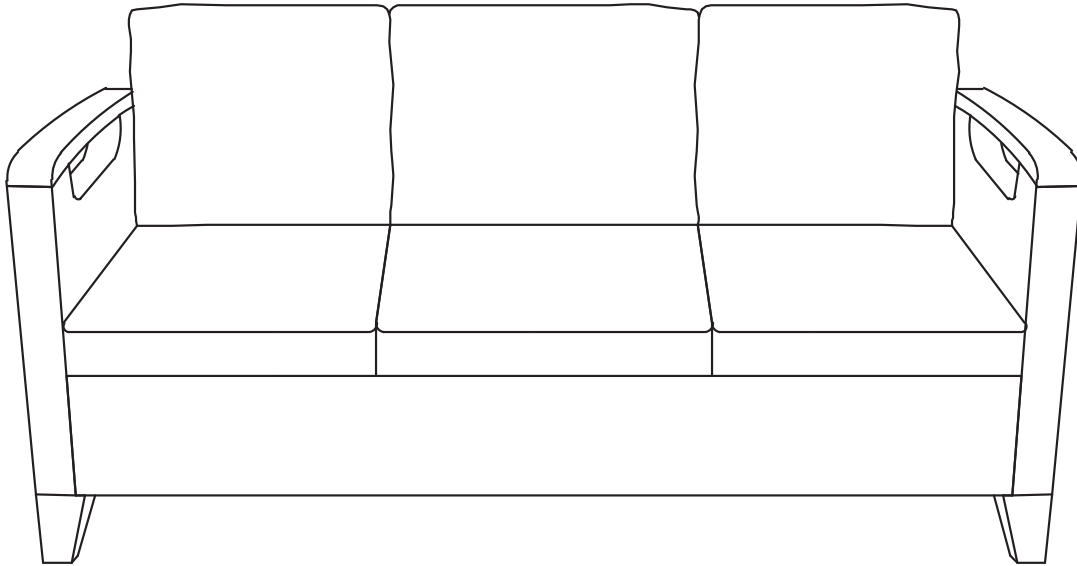

**Assembly
video**



For any missing hardware, damaged parts and other problems.
WELCOME to email us at: service@behousewell.com

Or call at 1-888-733-8169 Toll free
Between 9AM and 5PM Eastern time, Monday through Friday

***Don't fully tighten all the bolts till the very end!**

PRE-ASSEMBLY PREPARATION:

- A cordless drill is recommended for ease of assembly.
- Clear out the space for assembly and lay out all of the parts based on the Parts List, extra room will allow you to easily determine if all the pieces are present.
- Keep small parts and pieces away from children until fully assembled.



A1

Left arm
1 pc

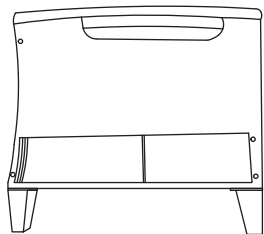

B2

Right back
1 pc

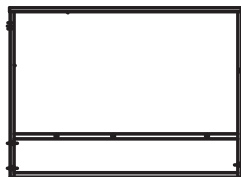

D

Seat
3 pcs

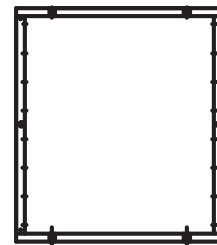

A2

Right arm
1 pc

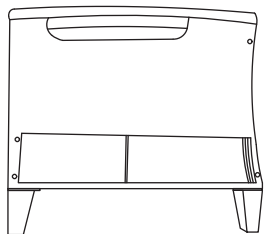

C1

Left front panel
1 pc



E

Middle foot
2 pcs



B1

Left back
1 pc

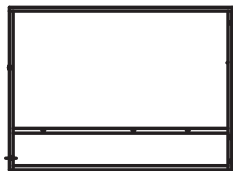

C2



Right front panel
1 pc



M+N

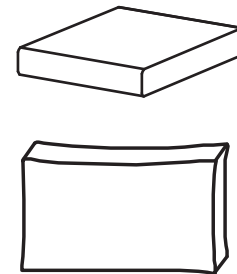

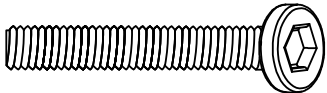
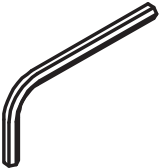
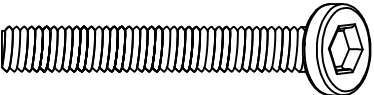
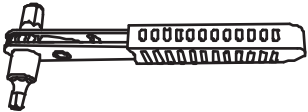
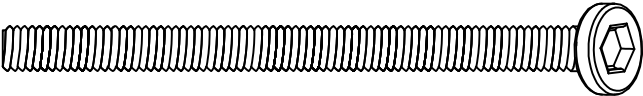
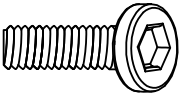
3 pcs seat cushion
3 pcs back cushion



| No. | Part/Size | QTY | Image | No. | Part/Size | QTY | Image |
|----------|--------------------------|-----------|---|----------|---------------------|-----------|---|
| F | Bolt (M6*35mm) | 10 | <p style="text-align: center;">**Actural Scale</p>  | K | Allen Wrench | 1 |  |
| G | Bolt (M6*40mm) | 12 | <p style="text-align: center;">**Actural Scale</p>  | L | Wrench | 1 |  |
| H | Bolt (M6*80mm) | 2 | <p style="text-align: center;">**Actural Scale</p>  | | | | |
| I | Bolt (M6*15mm) | 4 | <p style="text-align: center;">**Actural Scale</p>  | J | Washer | 28 |  |

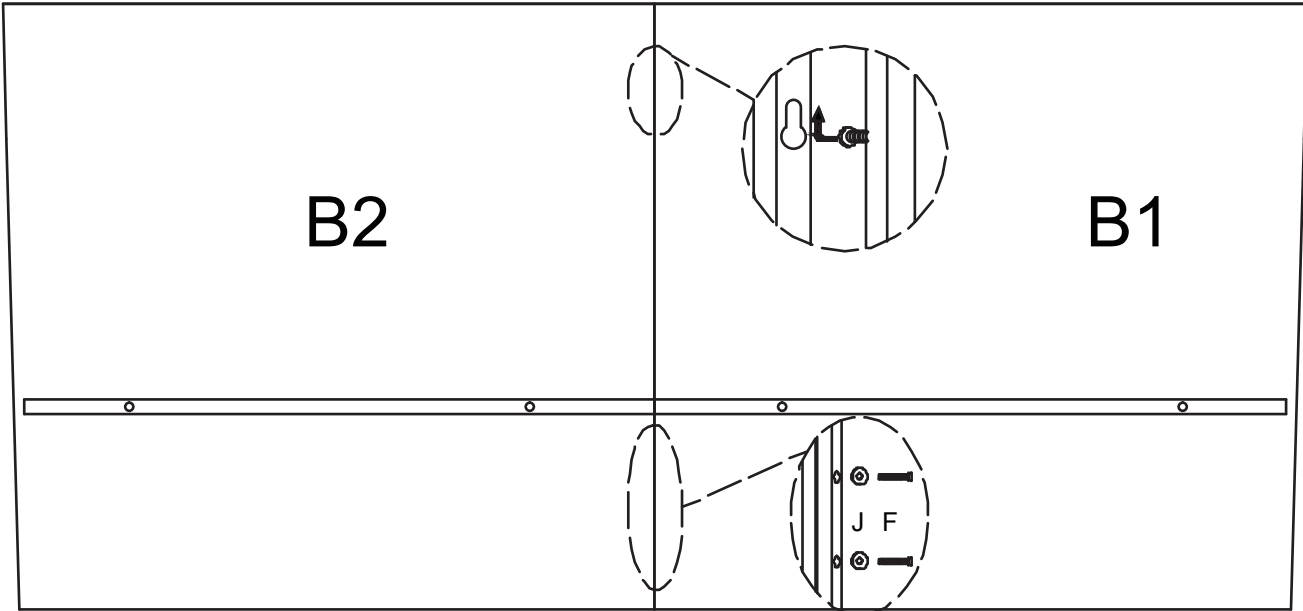

Step 1: Attach backs B1&B2 with 2pcs bolts F and 2pcs washers J, using Allen wrench K. Note: Don't fully tighten the bolts.



| | | | |
|---|--|------------|---|
| F |  | M6*35 | 2 |
| J |  | Ø16*Ø6.5*1 | 2 |



Step 2: Attach front panels C1&C2 with 2pcs bolts F and 2pcs washers J, using Allen wrench K. Note: Don't fully tighten the bolts.



| | | | |
|---|---|------------|---|
| F |  | M6*35 | 2 |
| J |  | Ø16*Ø6.5*1 | 2 |

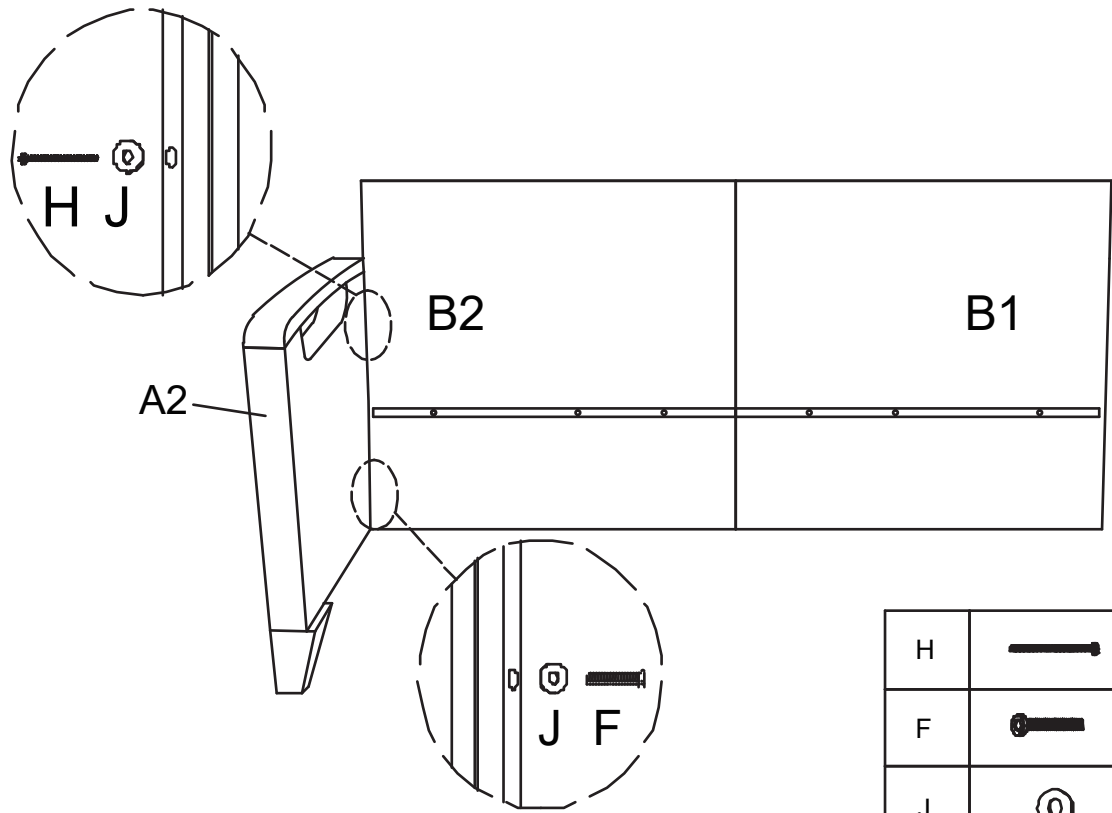

Step 3: Attach A2 to B2 with 1pc bolt H, 1pc bolt F and 2pcs washers J, using Allen wrench K. Note: Don't fully tighten the bolts.



| | | | |
|---|---|------------|---|
| H |  | M6*80 | 1 |
| F |  | M6*35 | 1 |
| J |  | Ø16*Ø6.5*1 | 2 |

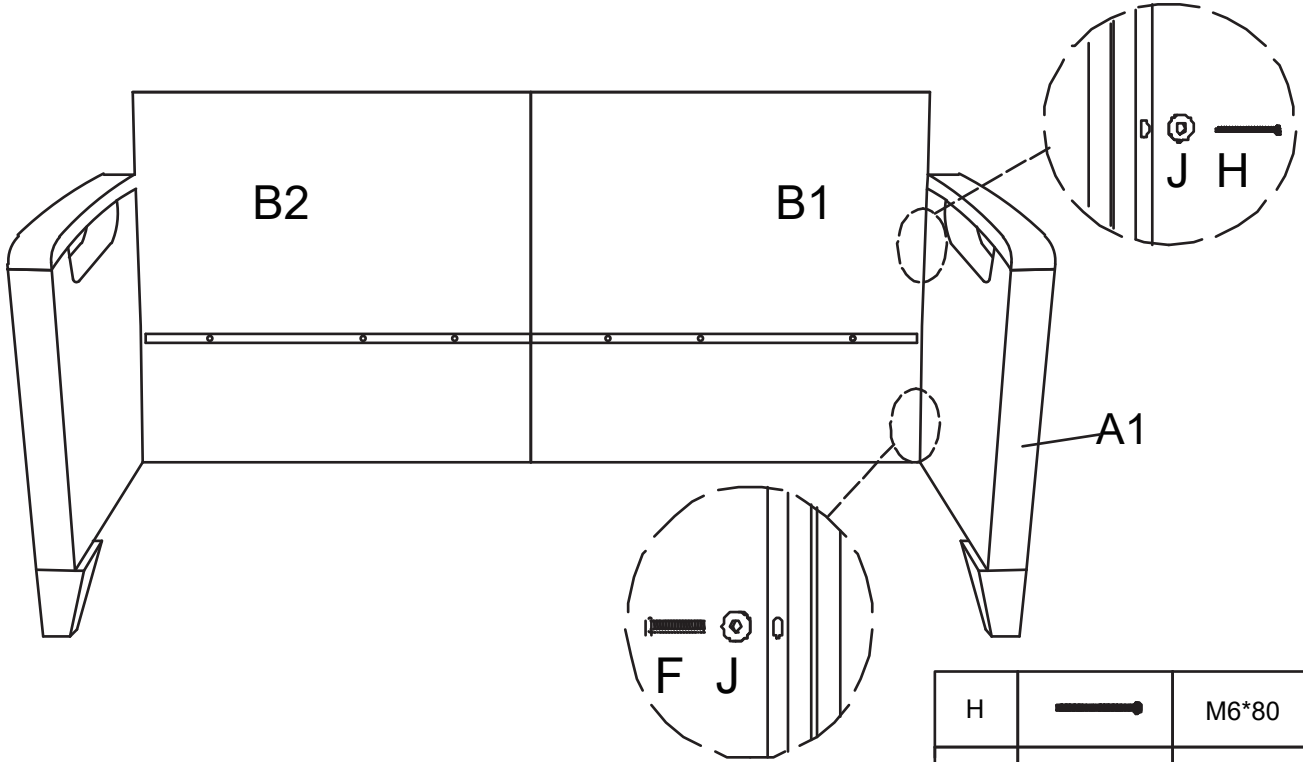

Step 4: Attach A1 to B1 with 1pc bolt H, 1pc bolt F and 2pcs washers J, using Allen wrench K. Note: Don't fully tighten the bolts.



| | | | |
|---|---|------------|---|
| H |  | M6*80 | 1 |
| F |  | M6*35 | 1 |
| J |  | Ø16*Ø6.5*1 | 2 |

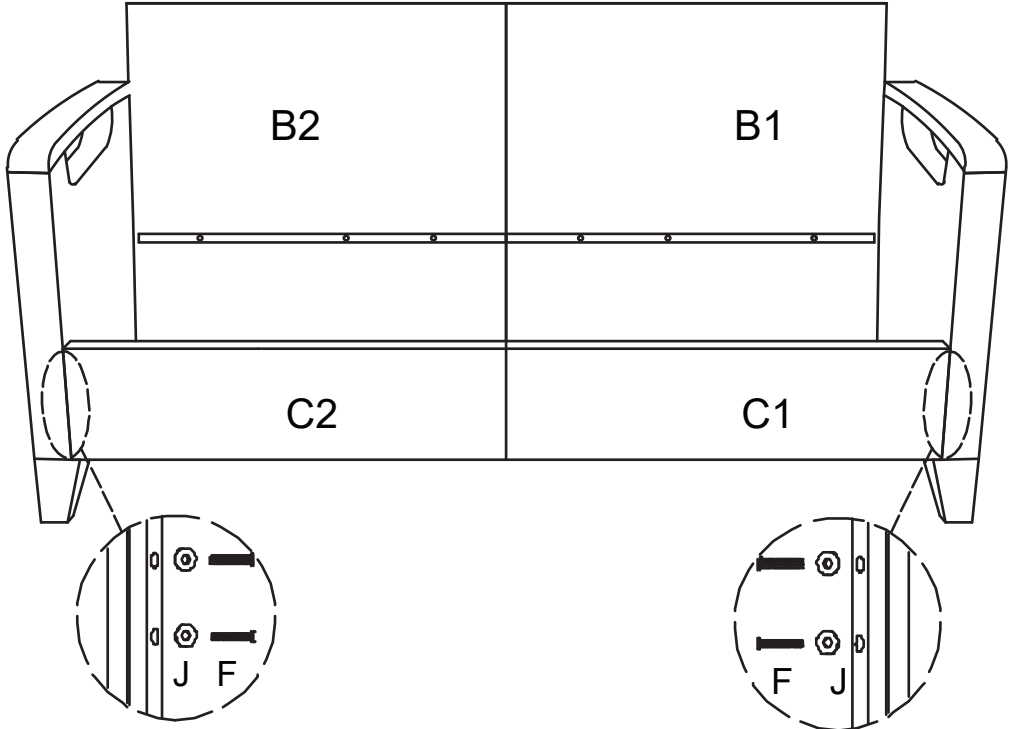

Step 5: Attach front panels C1&C2 to arms with 4pcs bolts F and 4pcs washers J, using Allen wrench K. Note: Don't fully tighten the bolts.

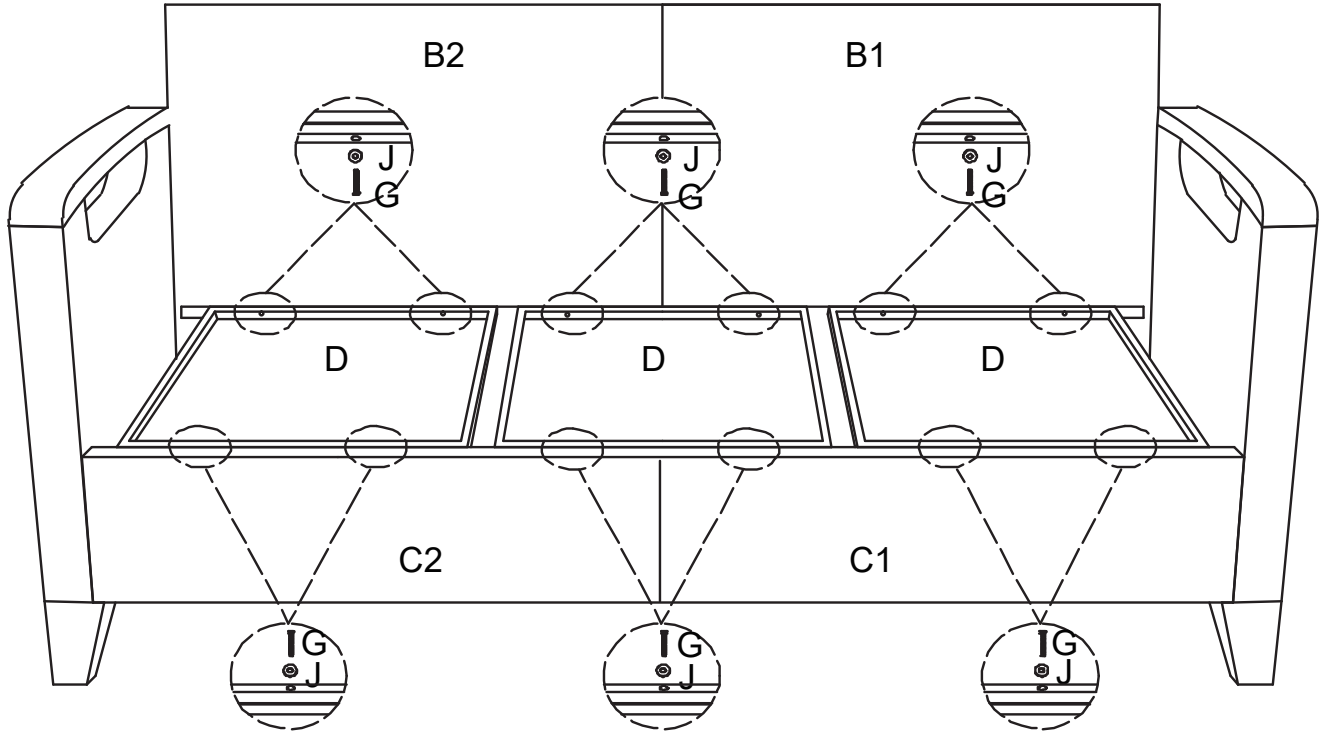

| | | | |
|---|---|------------|---|
| F |  | M6*35 | 4 |
| J |  | Ø16*Ø6.5*1 | 4 |

Step 6: Attach seat panels D to back panels and front panels with 12pcs bolts G and 12pcs washers J, using Allen wrench K. Note: Don't fully tighten the bolts.



| | | | |
|---|---|------------|----|
| G |  | M6*40 | 12 |
| J |  | Ø16*Ø6.5*1 | 12 |

Step 7: Attach middle 2pcs feet E to seat panels with 4pcs bolts I and 4pcs washers J, using Allen wrench K. Note: Please fully tighten all the bolts.

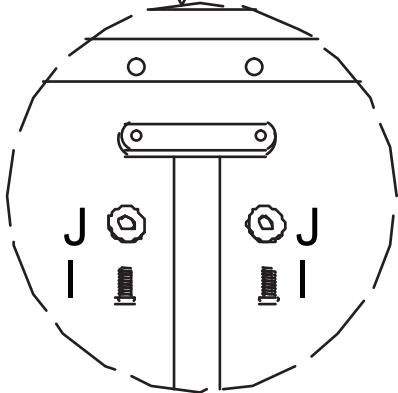
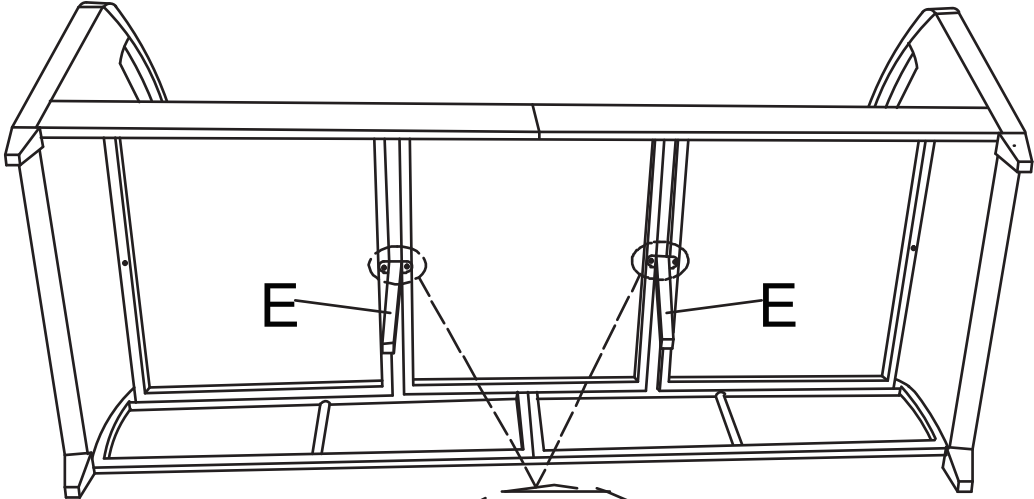

| | | | |
|---|---|------------|---|
| I |  | M6*15 | 4 |
| J |  | Ø16*Ø6.5*1 | 4 |

Step 8: Put seat cushions M and back cushions N onto the seat. Assembly is now complete and the product is ready for use.

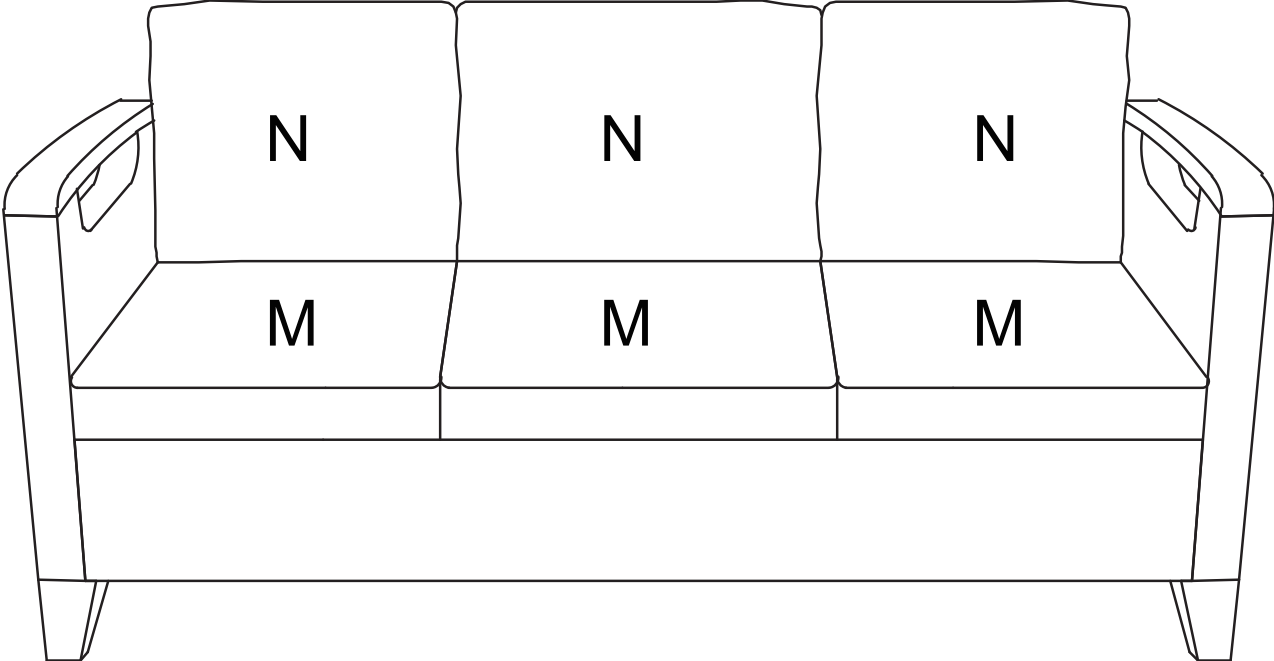

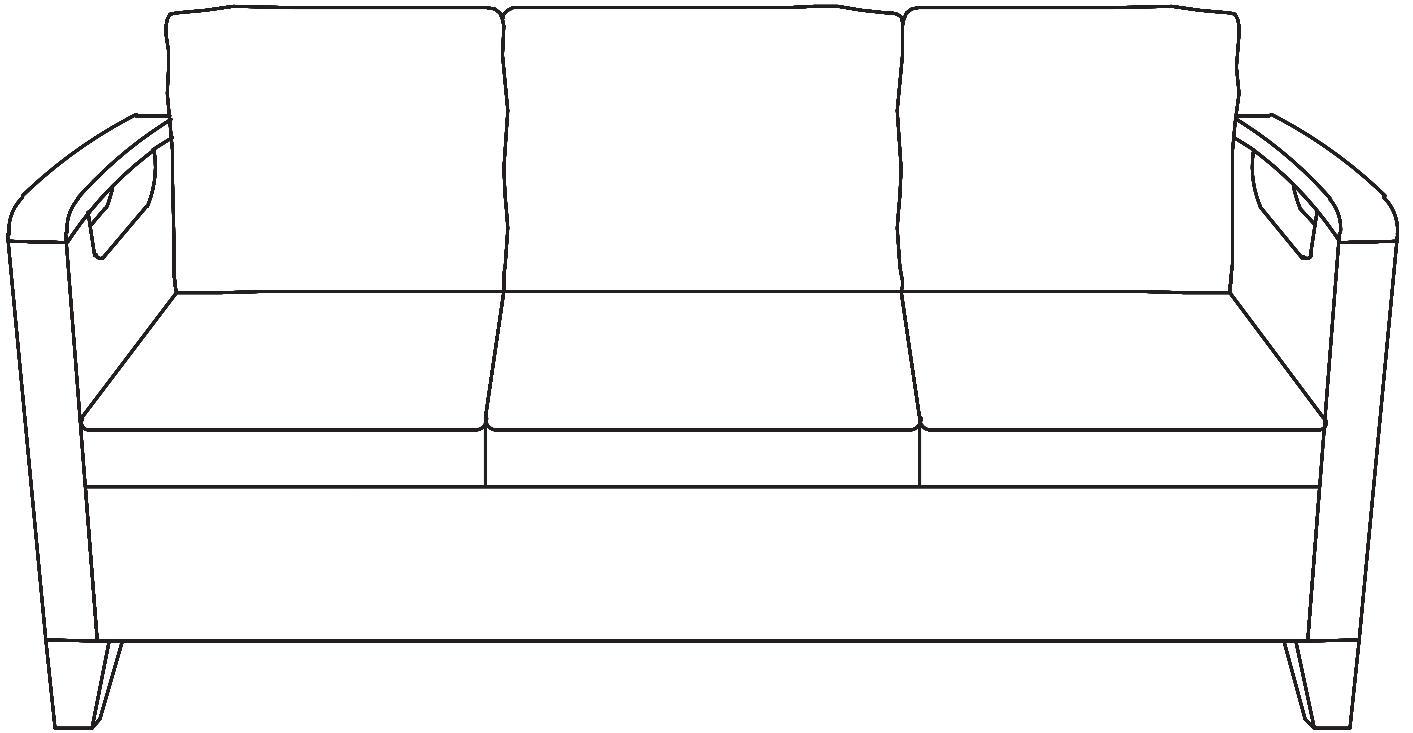

Q & A:

Q: Frame drilling holes not align?

A: If discrepancy less than 1/8 in., please loosen other relative bolts first, then adjust parts position and re-tight all bolts.

if discrepancy more than 1/4 in., it should be parts deformation during violent transportation, please contact us for parts replacement.

Q: Why cushion shrink packing and how to help it rebound faster?

A: We shrink packing cushion is to improve product value to cost, because it can save transport cost a lot. We filled it with more and high-quality filling than normal cushion to make sure it can be fully rebound. Following up this video(<https://youtu.be/IZAIHQU9Ial>)method to speed up rebounding.

Q: Coffee table legs un-even?

A: Loosen bolts, then press table downwards, then tighten bolts again. If it can not solve problem, please contact us for parts replacement.

Q: Wicker colors different on parts?

A: We make wicker stripes to fit for nature environment, colors may various circularly. So when those wicker stripes hand-woven on product randomly, it may looks different on parts.

Q: Why some swivel plate not work well?

A: Swivel plate may need a running-in period like 10~20 cycles. If it still not swivel well, please contact us for swivel plate replacement.

Q: Bolts are not long enough for assembly sometimes?

A: Sometimes gaps maybe larger than the bolts to reach out when assembly, please contact us for longer bolts. After all, those parts are woven by hand-made. But after it assembled and all bolts tightened, the gaps will be disappeared, because wicker parts are flexible surface.

Q: Parts received damaged?

A: Although we had already did our best to pack products well, there are also unpredictable transport damages accident happened from time to time. When it happens, please contact our after-sales email, state the order number/which shopping platform it comes from/one of the parcel tracking number, and provide the relevant pictures of the problem, we will immediately provide you with a suitable replacement parcel.

Q:Received item but missing hardware or parts

A:Please contact our after-sales email, state the order number/which shopping platform it comes from/one of the parcel tracking number, and provide the relevant pictures of the problem, we will immediately provide you with a suitable replacement parcel.

How to take care of the product

1. Maintain your outdoor furniture by using furniture covers or storing out of the elements when not in use.

2. Wicker: Wipe surface dust with warm water

3. Frame: Clean frames with a mild soap and warm water, rinse with clean water and dry thoroughly. Do not use abrasive materials or strong detergents

4. Fabric: Clean with mild soap and water. Do not put cushions in dryer.

5. In cold climates, drain any water accumulated inside the frames before storing.