

# Storage Simple Base

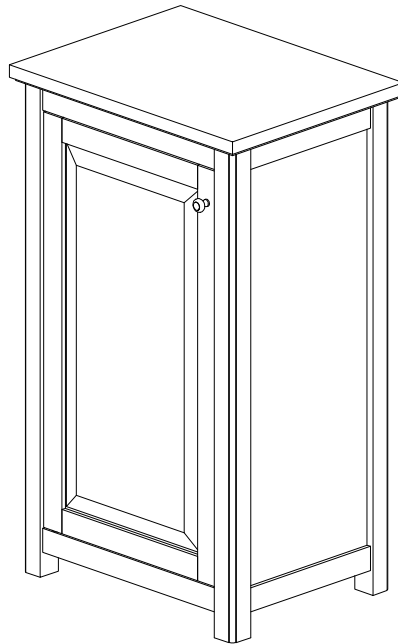





Thank you for purchasing the Storage Simple Base. We have found it helpful to have a second person present during the assembly process.

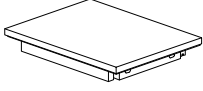
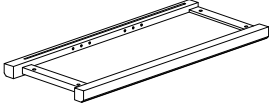
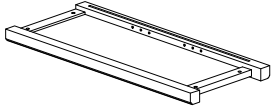
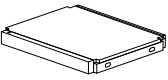

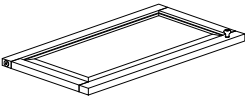
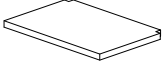
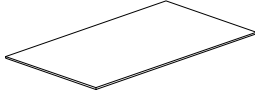

## Storage Simple Base Assembly Instructions

### Parts

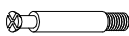
NO.	DRAWING	DESCRIPTION	QTY
<b>A</b>		TABLE TOP	<b>1</b>
<b>B</b>		RIGHT SIDE FRAME	<b>1</b>
<b>C</b>		LEFT SIDE FRAME	<b>1</b>
<b>D</b>		BOTTOM FRAME	<b>1</b>

NO.	DRAWING	DESCRIPTION	QTY
<b>E</b>		DOOR	<b>1</b>
<b>F</b>		SHELF	<b>2</b>
<b>G</b>		BACK PANEL	<b>1</b>

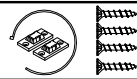
NO.	DRAWING	DESCRIPTION	QTY
H		M6x35MM BOLT	8
I		M6x45MM BOLT	1
J		WASHER	1
K		40MM BOLT	1

L		SHELF CLIP	8
M		ALLEN KEY	1
N		ANTI-TIP	1
O		KNOB	1
P		KNOB SCREW	1

## Step 1

Read through these instructions thoroughly before beginning assembly. We have found this to be of great value when assembling this product.

## Step 2

Remove all parts and hardware from packing material. Wooden pieces should be placed on a non abrasive surface to prevent damage to the finish

## Step 3

Lay Table Top Assembly (A) upside down on a non abrasive surface. Attach Right Side Frame (B) to Table Top (A) using 2-M6x35MM Hex Bolts (H).NOTE: DO NOT TIGHTEN ALL BOLTS AT THIS TIME !

Attach Left Side Frame (C) to Table Top (A) using 2-M6x45MM Hex Bolts (H). NOTE: DO NOT TIGHTEN ALL BOLTS AT THIS TIME ! Align Back Panel (G) with groves in Side Frame Assembly (B)&(C)-Slide Back Panel (D) into place.

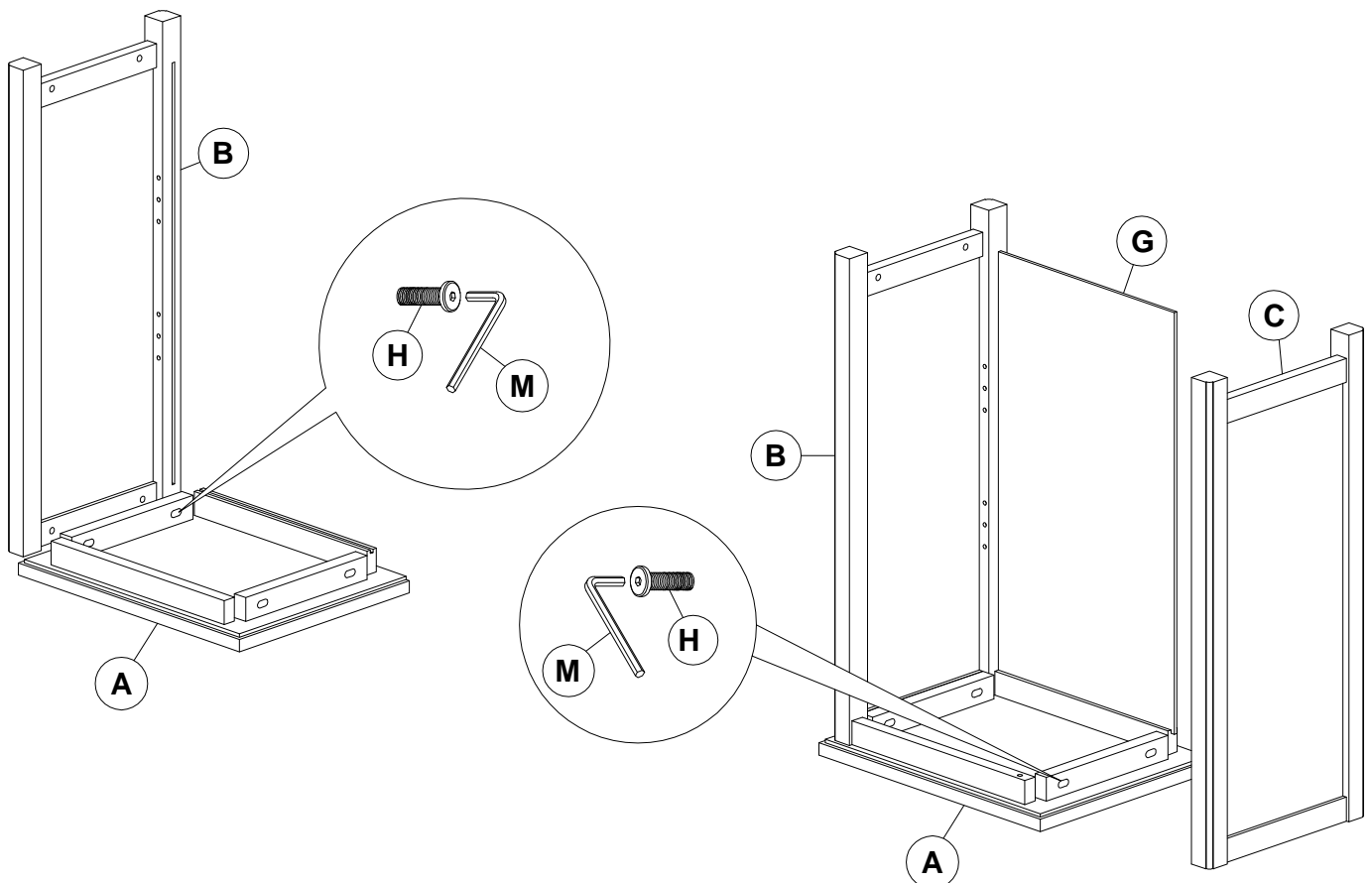

## Step 4

Attach Bottom Frame (D) to Side Frame Assembly (B)&(C) using 4-M6x35MM Hex Bolts (H). NOTE: TIGHTEN ALL BOLTS AT THIS TIME !

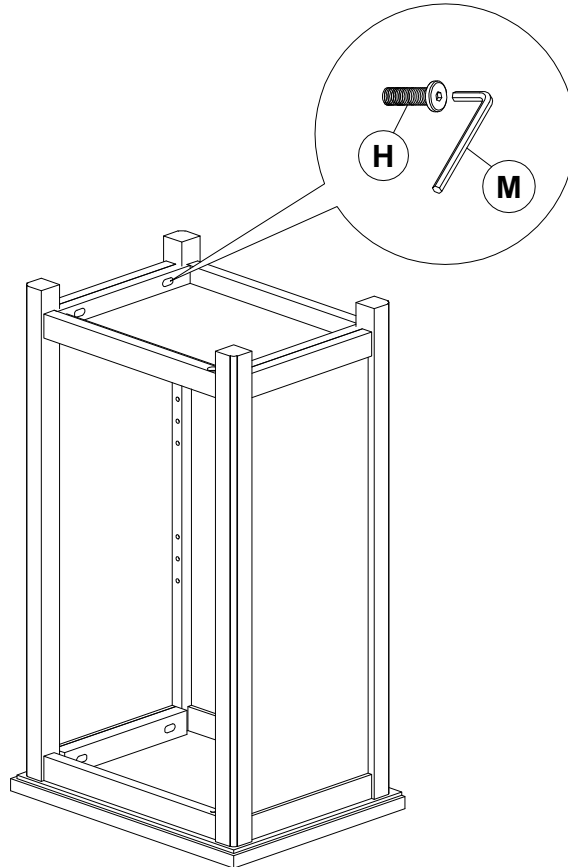

## Step 5

Insert 8-Shelf Clips (L) in Holes on Side Frames at desired location. Place Shelves (F) on Shelf Clips (L). Attach Knob (O) to Door (E) using Knob Screw (P).

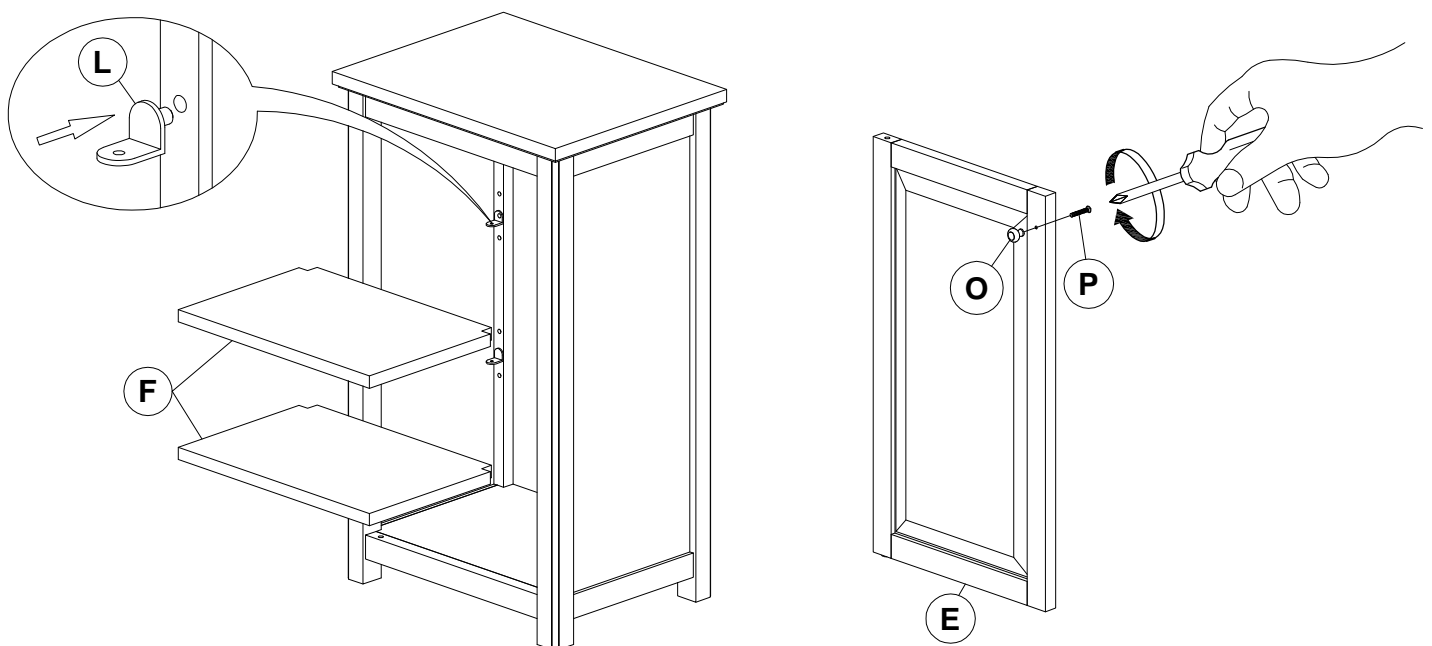

## Step 6

Attach door (E). Insert 40MM Bolt (K) into Threaded Insert in underside of rail on Top Assembly. Align hole on Top of Door (E) with 40MM Bolt (K). Align Washer (J) between Holes on Bottom of Door and upperside Bottom Frame (D). Thread 1-M6x45MM Hex Bolt (I) thru rail on Bottom Frame (D) and Washer (J). Align into Hole on Bottom of Door (E).

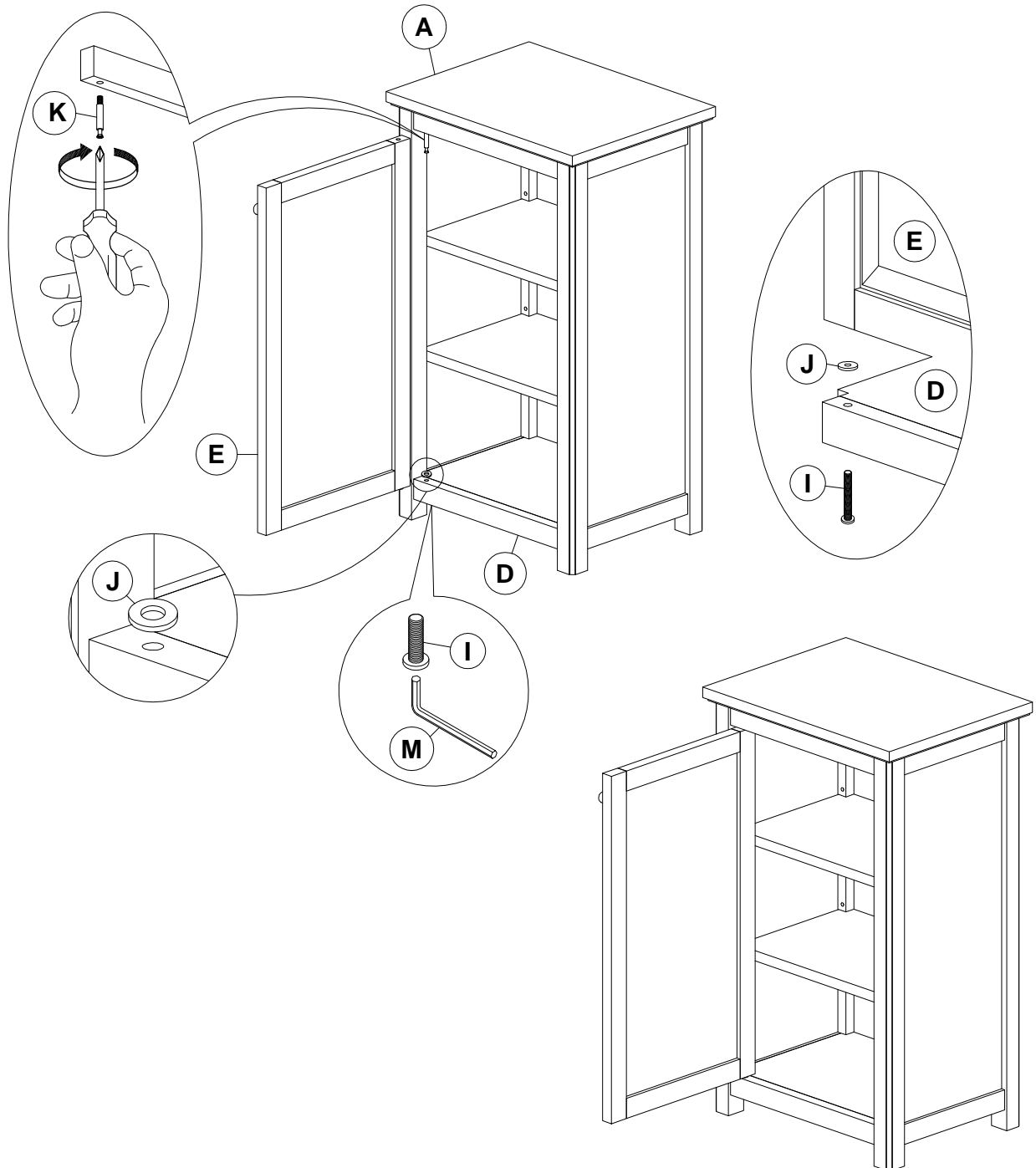

---

## CARE

Clean with a non abrasive cloth using a mild soap. Make sure to wipe dry.

---