

**BAR MAISON -
24"X 36" / MARBRE GRIS / METAL CHARBON**

**HOME BAR -
24"X 36" / GREY MARBLE / CHARCOAL METAL**

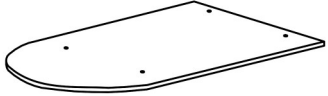
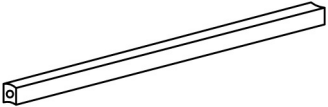
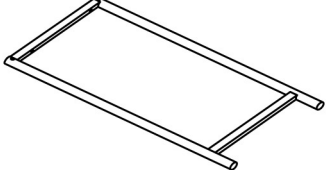
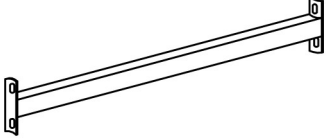
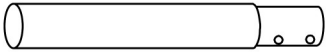

LISTE DES PIÈCES
PARTS LIST

PIÈCE / PART #	IMAGE	DESCRIPTION	QTY / QTÉ
1		BAR TOP SURFACE DU BAR	1
2		SUPPORT BAR BARRE DE SOUTIEN	2
3		SIDE FRAME CADRE DE CÔTÉ	2
4		CROSSBAR BARRE TRANSVERSALE	2
5		TABLE LEG FOR EXTENSION PATTE DE TABLE POUR EXTENSION	4

LISTE DES PIÈCES DE MONTAGE
HARDWARE LIST

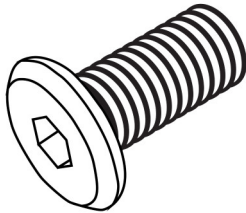
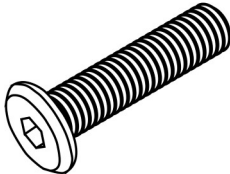
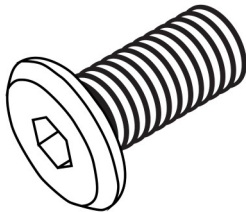
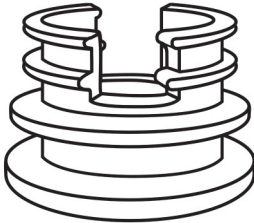
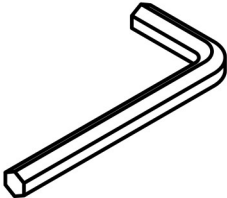
PIÈCE / PART #	IMAGE	DESCRIPTION	QTY / QTÉ
A		ASSEMBLING BOLT - Ø 1/4" X 3/4" BOULON D'ASSEMBLAGE - Ø 1/4" X 3/4"	16
B		ASSEMBLING BOLT - Ø 1/4" X 1 3/4" BOULON D'ASSEMBLAGE - Ø 1/4" X 1 3/4"	4
C		ASSEMBLING BOLT - Ø 1/4" X 1 1/8" BOULON D'ASSEMBLAGE - Ø 1/4" X 1 1/8"	4
D		FLOOR PROTECTOR - Ø 1" PROTECTEUR DE PLANCHER - Ø 1"	4
E		HEX KEY CLÉ HEXAGONALE	1

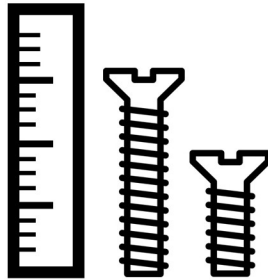

OUTIL DE VÉRIFICATION DE DIMENSIONS DES PIÈCES
HARDWARE DIMENSIONS VERIFICATION TOOL

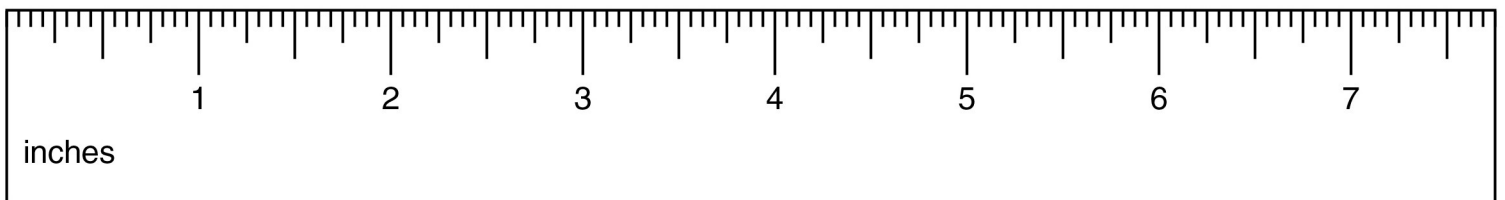

ÉTAPE / STEP 1

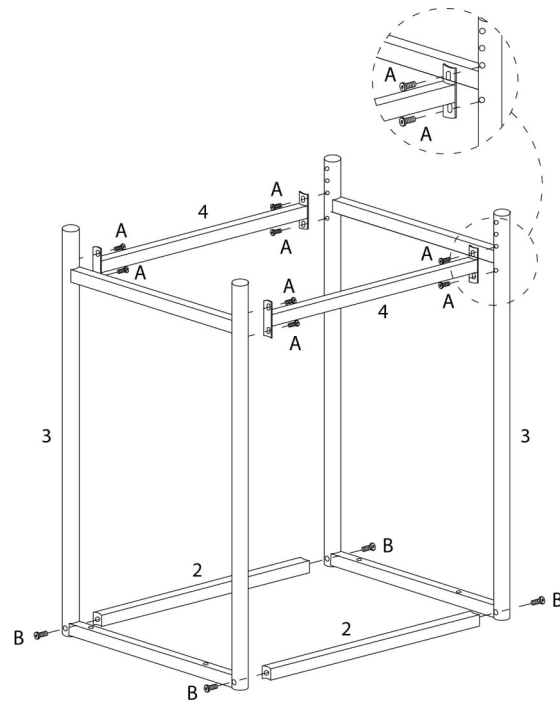

ÉTAPE / STEP 2

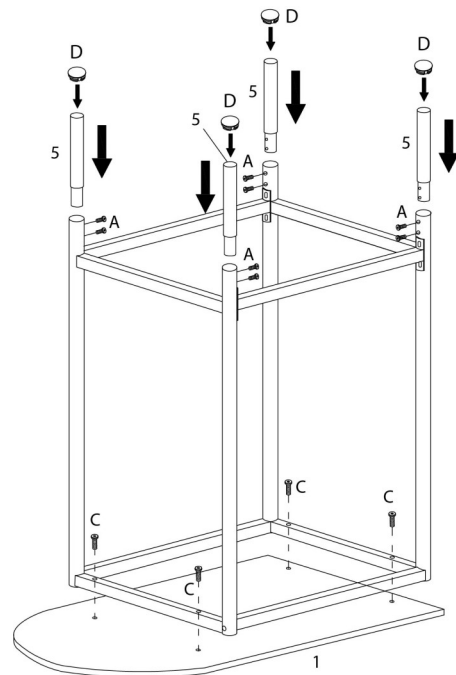

ÉTAPE / STEP 3

