

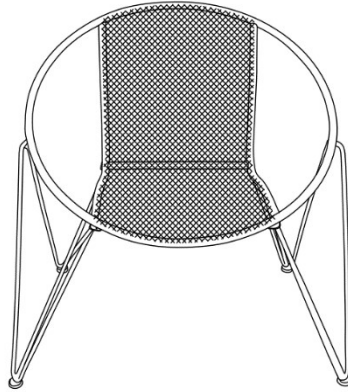

Assembly Instructions

Caution : You must read this before you proceed



Chair

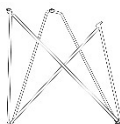

Parts List

Label	Picture	Description	QTY
A		Chair Seat	1
B		Left Leg Frame	1
C		Right Leg Frame	1

Hardware

Label	Picture	Description	QTY
①		Bolt (M6*20mm)	7
②		Washer	7
③		Allen key	1

Assembly Preparation

Before Beginning Assembly :

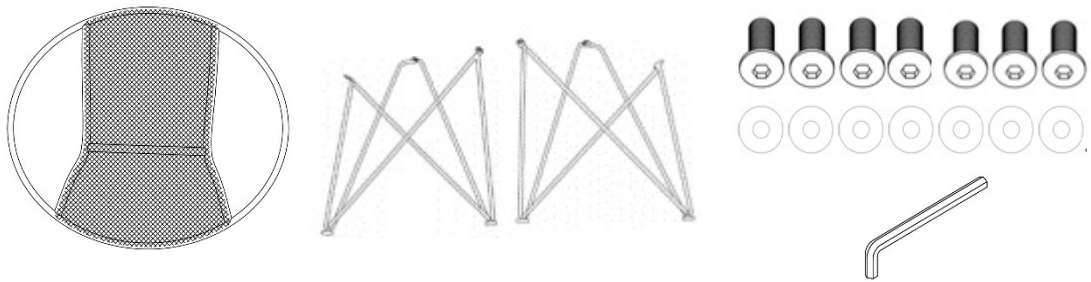

- Read instructions, cover to cover-



- Have 2 adults on hand for assembly-



- Do not assemble on flooring or carpet-



- Assemble on a clean non-marring surface (packing foam)-



- Save all packaging until finished-

Assembly Steps

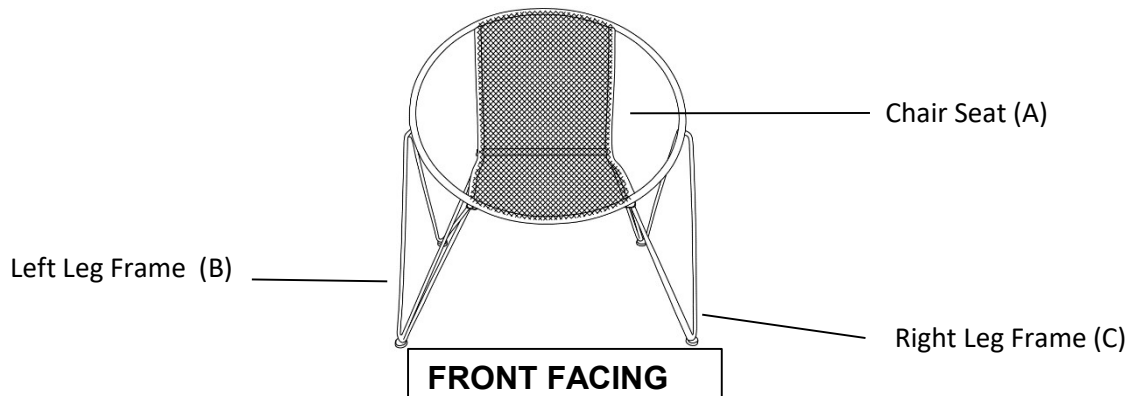

This Chair has multiple parts and may require up to some 30 minutes to assemble. To give you an overview of the Chair parts, the above picture is to help you put the various parts into perspective. Please read through the instructions herebelow to familiarise the parts and steps before assembly.

Step 1

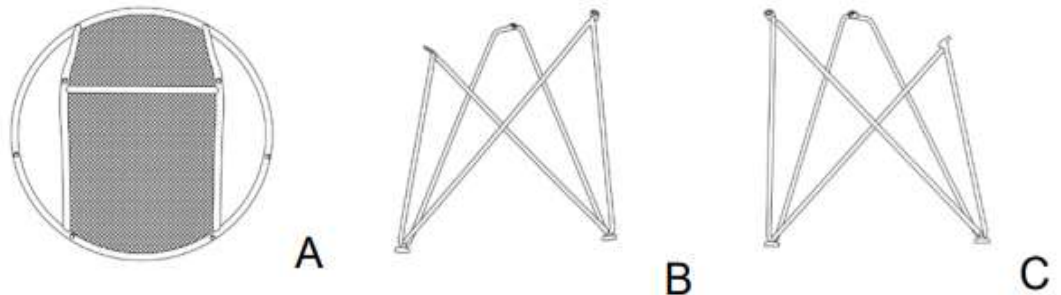

Open the carton and place all parts on a clean, non-marring surface.

Step 2

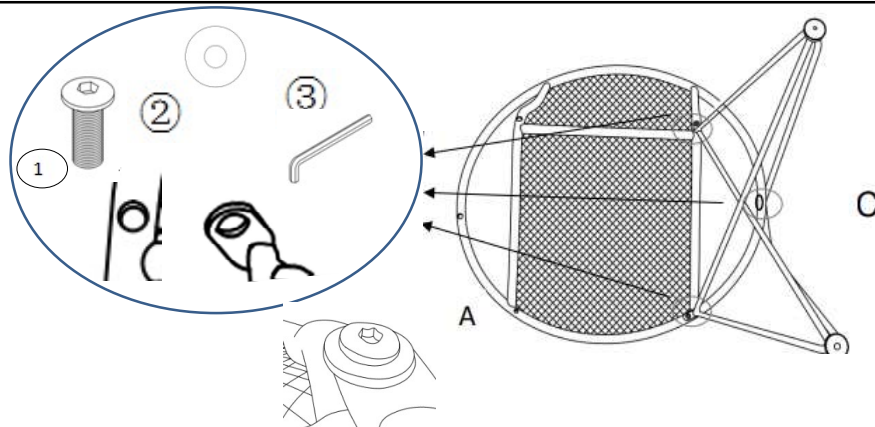

Place the Chair seat(A) face down on the clean and soft surface.
Insert Right Leg Frame(C) into Chair seat(A) as shown above.
Attach Right Leg Frame(C) to Chair seat(A) using Bolts(①) + washer(②) with Allen key(③) as shown above.

Do not fully tighten the Bolts.

Step 3

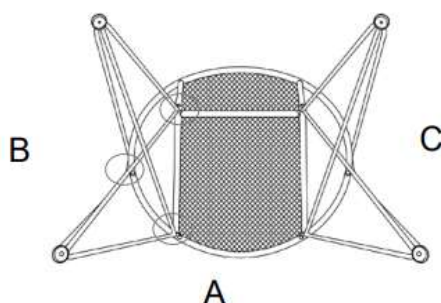

Repeat Step 2, to attach Left Leg Frame(B) to Chair seat(A).

Do not fully tighten the Bolts.

Step 4

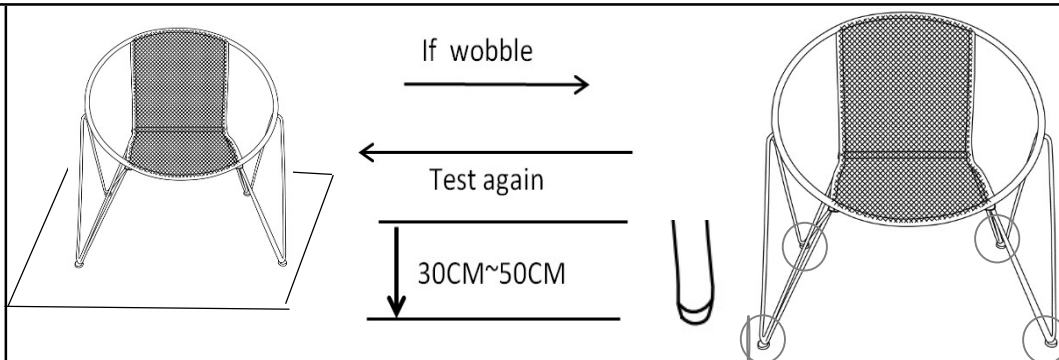

Stand the Chair right way up. Place the Chair on a LEVEL SURFACE to check for wobbles.
If it wobbles, lift the chair some 20cm to 30cm high from the ground.
Keep your feet and toes well away from the drop zone.
Drop the chair freely and vertically with all four legs, hitting the ground, at the same time.

When tightening these bolts, tighten sequentially.

DO NOT tighten any screw fully and then towards the next one.

This would cause the frame to warp.

If there is still wobbles, loosen the bolts and execute this same drop tests.

IF CHAIR IS NOT STABLE , IT COULD LEAD TO DAMAGING THE PRODUCT.

Step 5

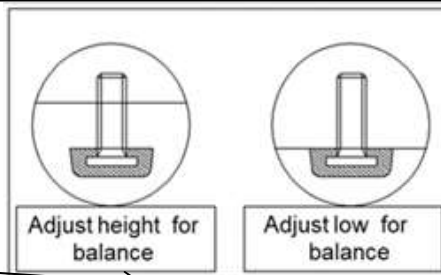
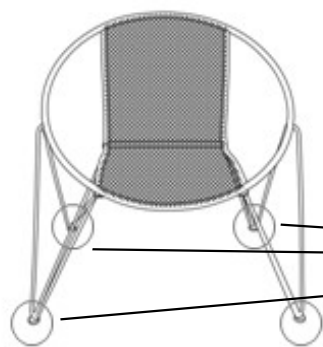



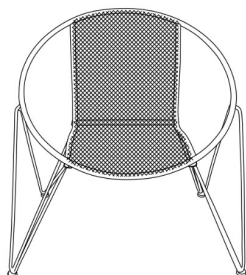







Adjust the Legs Pre-installed Levellers until the Chair is level with the ground.
To adjust the Levellers, tilt the Chair to rest on 2 legs, with assistance from your adult partner.
Adjust the levellers to the desired height to avoid wobbles.



Stand the Chair, then your Chair is ready for use.
This Chair can only be used on the flat and level surface.

Care & Maintenance

- ⊘  ● Do not put hot items directly on furniture surface.
- ⊘  ● Do not clean furniture with harsh cleansers or polish.
- ⊘  ● Do not place furniture under direct sunlight.
- ⊘  ● Do not place furniture near heating or cooling vents.
- ⊘  ● Do not write on furniture without a padded barrier to protect the surface.
- ⊘  ● Do not place furniture outside. For indoor use only.
- ⊘  ● Not for commercial use. For residential use only.
- ⊘  ● Stains may be removed with mild soap solution and damp cloth.
- ⊘  ● Children should not climb or jump on the furniture.
- ✓  ● Dust and pick-up spills using a clean, non-colored, lint-free cloth.