











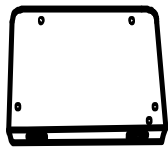

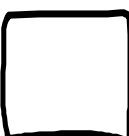
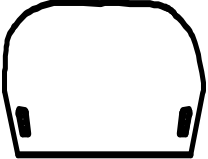
ASSEMBLY INSTRUCTION

Lx1 	Rx1 	Ax1 	Bx1 
Cx1 	Dx1 	Ex1 	Fx2 
Gx2 	Hx2 	①x8  The two extra are spare.	②x6 
③x6 	④x1 		

STEP 1

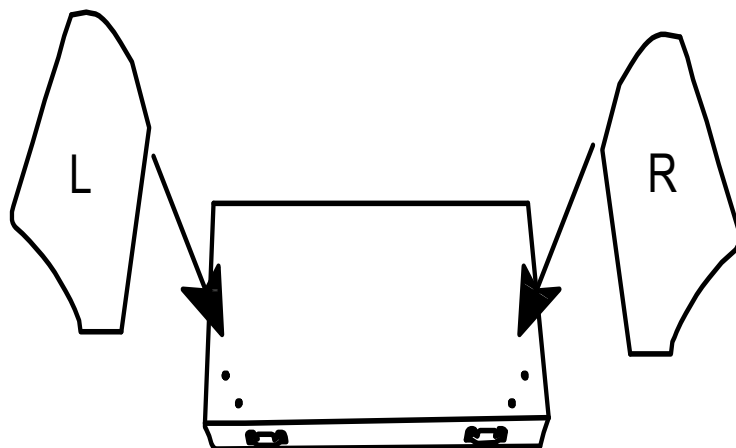

A

STEP 2 Insert the bolts with 80% firmness

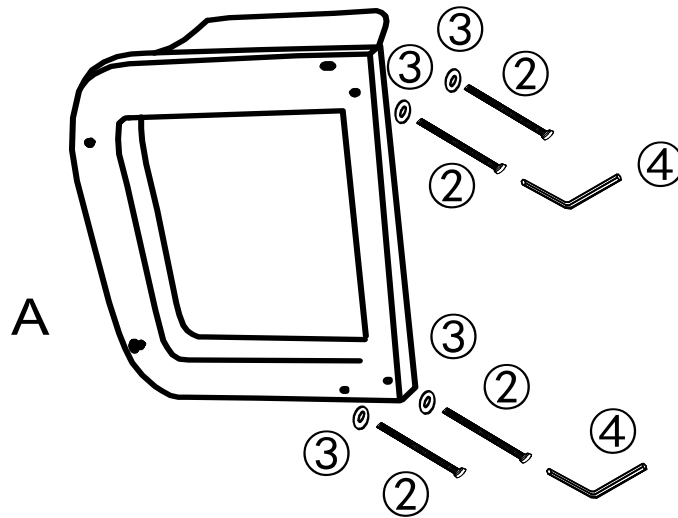

STEP 3

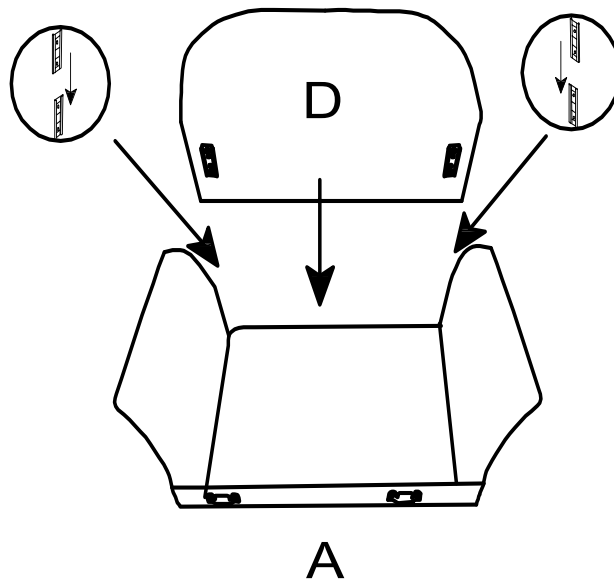

STEP 4

Insert the bolts with 80% firmness

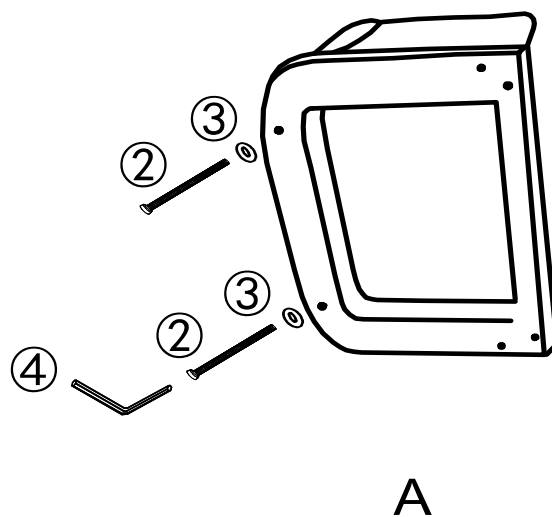

STEP 5

Tighten up all the screws with 100% firmness

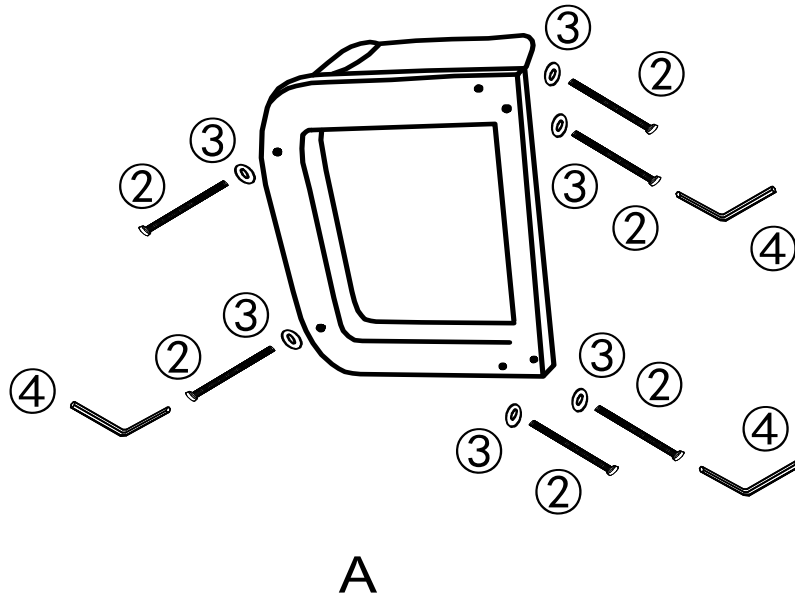

STEP 6

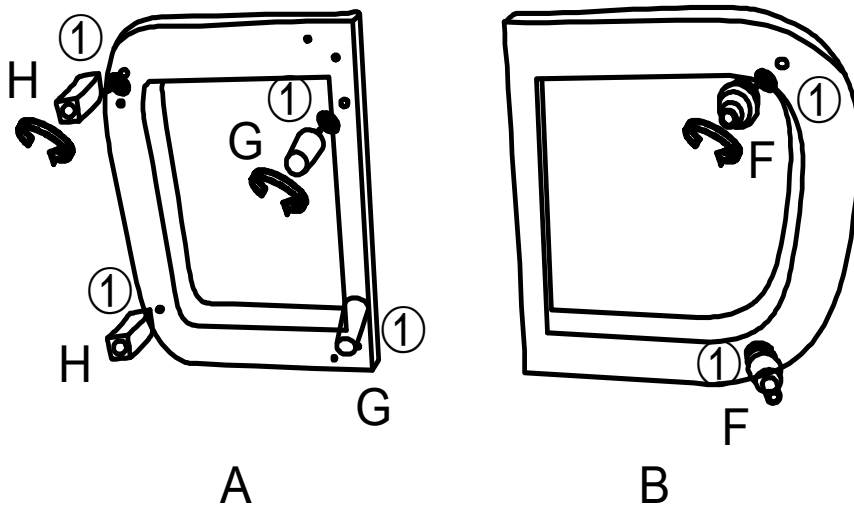

STEP 7

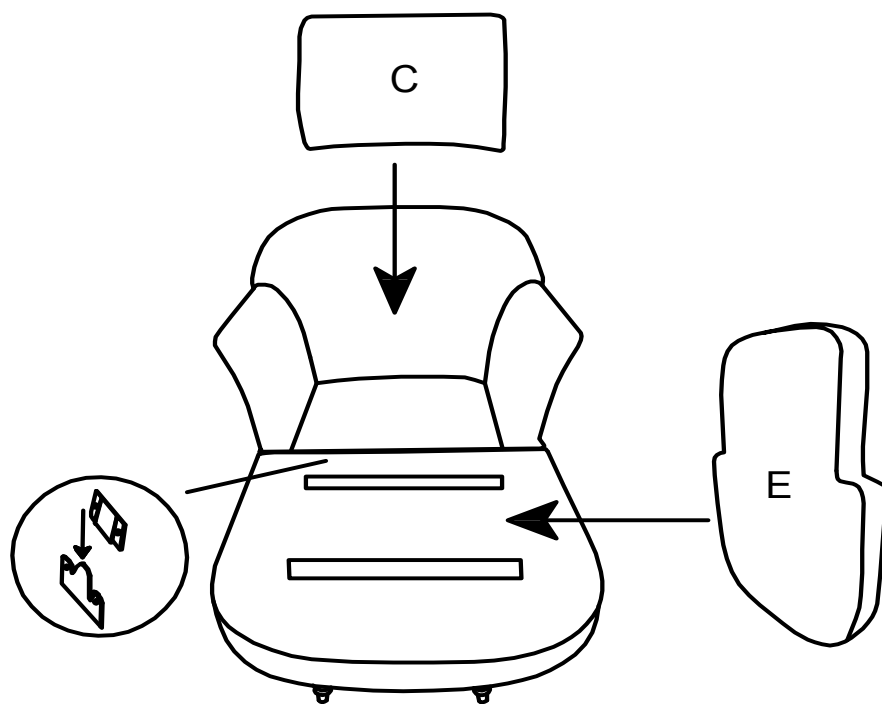

STEP 8

