

USE AND CARE GUIDE



01 Table of Contents

Safety Information	1
Warranty	2
Three ceiling installation methods	3
Accessory drawing	4
Installation procedure	5

Remote control manual	12
Match code	13
Fans Balance	14
Care and cleaning	15
Trouble shooting	15
Connecting Smart Systems	16

02 Safety Information

READ ALL SAFETY INFORMATION AND INSTALLATION INSTRUCTIONS BEFORE YOU BEGIN INSTALLING THE FAN AND SAME INSTRUCTIONS.



Warning:
Kindly turn off the power
when connecting cables.



1. To reduce the risk of electric shock, ensure the electricity has been turned off at the circuit breaker or fuse box before you begin.
2. All wiring must be in accordance with the National Electrical Code ANSI/NFPA 70-1999 and local electrical codes. Electrical installation should be performed by a qualified licensed electrician.
3. The outlet box and support structure must be securely mounted and capable of reliably supporting 35 lbs. (15.9 kg) Use only UL Listed outlet boxes marked "Acceptable for Fan Support of 35 lbs. (15.9 kg) or less".
4. The fan must be mounted with a minimum of 7 ft. (2.1 m) clearance from the trailing edge of the blades to the floor.
5. Do not place objects in the path of the blades.
6. To avoid personal injury or damage to the fan and other items, use caution when working around or cleaning the fan.
7. Electrical diagrams are for reference only. Light kits that are not packed with the fan must be UL-listed and marked suitable for use with the model fan you are installing. Switches must be UL General Use Switches. Refer to the instructions packaged with the light kits and switches for proper assembly.
8. After making electrical connections, spliced conductors should be turned upward and pushed carefully up into the outlet box. The wires should be spread apart with the grounded conductor and the equipment-grounding conductor on one side of the outlet box.
9. All setscrews must be checked and re-tightened where necessary before installation.



WARNING: To reduce the risk of personal injury, do not bend the blade brackets (also referred to as flanges) during assembly or after installation. Do not insert objects in the path of the blades.



WARNING: To reduce the risk of fire or electric shock, this fan is NOT suitable for use with solid-state speed controls.



WARNING: To avoid possible electrical shock, make sure that the electricity is turned off at the main power box before starting work. If you feel you do not have enough electrical wiring knowledge or experience, contact a licensed electrician.



WARNING: Electrical diagrams are for reference only. Optional use of any light kit shall be UL-listed and marked suitable for use with this fan



WARNING: To reduce the risk of fire, electrical shock or personal injury, ensure that the fan mounting bracket is supported directly from the building structure or the outlet box marked "Acceptable for Fan Support of 35 lbs. (15.9 kg) or less". Use only the screws provided with the outlet box.



WARNING: Do not short-circuit, disassemble, heat up, connect improperly, or dispose of used batteries in fire. Do not recharge or mix batteries with used or other battery types. Immediately remove used batteries



WARNING: Chemical Burn Hazard. Keep batteries away from children. This product contains a lithium button/coin cell battery. If a new or used lithium button/coin cell battery is swallowed or enters the body it can cause severe internal burns and can lead to death in as little as 2 hours. Always completely secure the battery compartment. If the battery compartment does not close securely stop using the product. Remove the batteries and keep it away from children. If you think batteries might have been swallowed or placed inside any part of the body, seek immediate medical attention



WARNING: a) The cells shall be disposed of properly including keeping them away from children; and b) Even used cells may cause injury.



WARNING: Do not test the fan before affixing the blades. The DC motor needs a load to rotate properly. Affixing blades and then testing the fans.

03 Warranty

The supplier warrants the fan motor to be free from defects in workmanship and material present at time of shipment from the factory for a lifetime after the date of purchase by the original purchaser. The supplier also warrants that all other fan parts, excluding any glass or acrylic blades, to be free from defects in workmanship and material at the time.

of shipment from the factory for a period of two years after the date of purchase by the original purchaser. We agree to correct such defects without charge or at our option replace with a comparable or superior model if the product is returned.

To obtain warranty service, you must present a copy of the receipt as proof of purchase. All costs of removing and re-installing the product are your responsibility. Damage to any part such as by accident, misuse, improper installation, or by affixing any accessories, is not covered by this warranty.

Because of varying climatic conditions this warranty does not cover any changes in brass finish, including rusting, pitting, corroding, tarnishing, or peeling. Brass finishes of this type give their longest useful life when protected from varying weather conditions. A certain amount of "wobble" is normal and should not be considered a defect.

Servicing performed by unauthorized persons shall render the warranty invalid. There is no other express warranty. We hereby disclaims any and all warranties, including but not limited to those of merchant ability and fitness for a particular purpose to the extent permitted by law. The duration of any implied warranty which cannot be disclaimed is limited to the time period as specified in the express warranty. Some states do not allow a limitation on how long an implied warranty lasts, so the above limitation may not apply to you.

The retailer shall not be liable for incidental, consequential, or special damages arising out of or in connection with product use or performance except as may otherwise be accorded by law. Some states do not allow the exclusion of incidental or consequential damages, so the above exclusion or limitation may not apply to you. This warranty gives specific legal rights, and you may also have other rights which vary from state to state. This warranty supersedes all prior warranties. Shipping costs for any return of product as part of a claim on the warranty must be paid by the customer.

04 Three ceiling installation methods

Concrete Ceiling Mounting Bracket

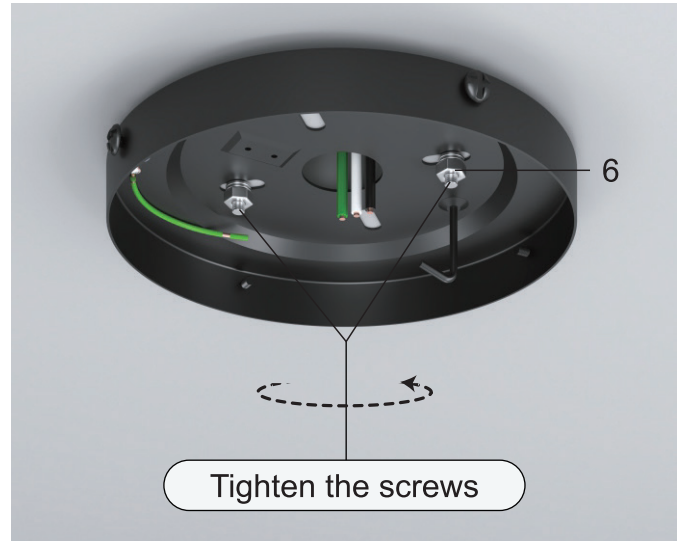
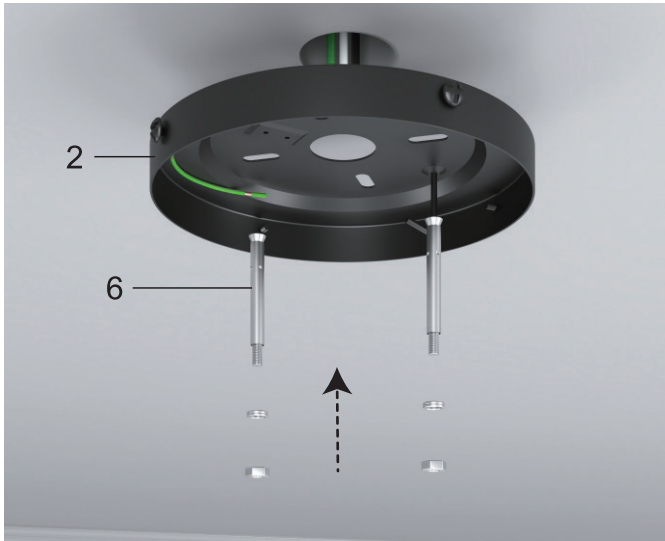

Hanger for Junction Box Mounting Bracket

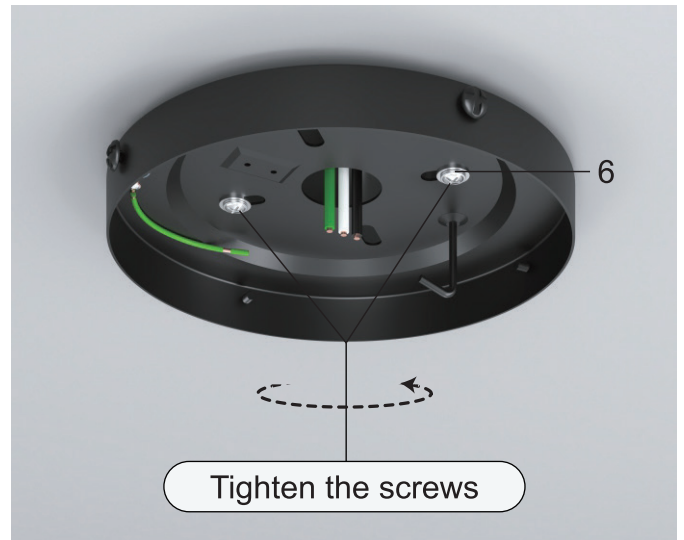
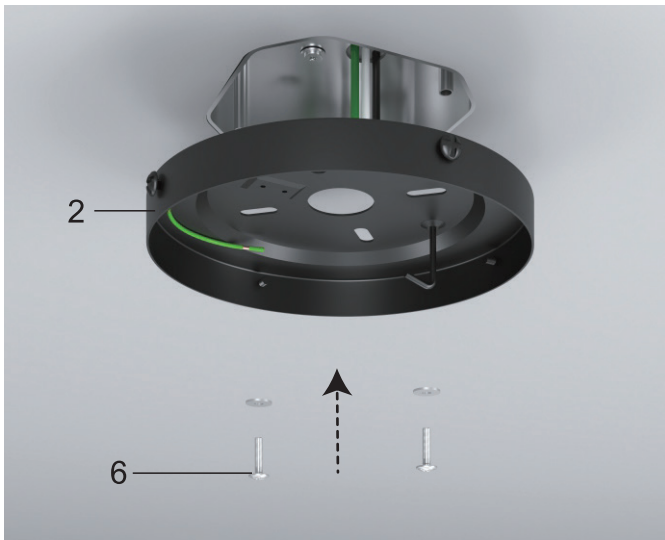

Wooden ceiling Mounting Bracket

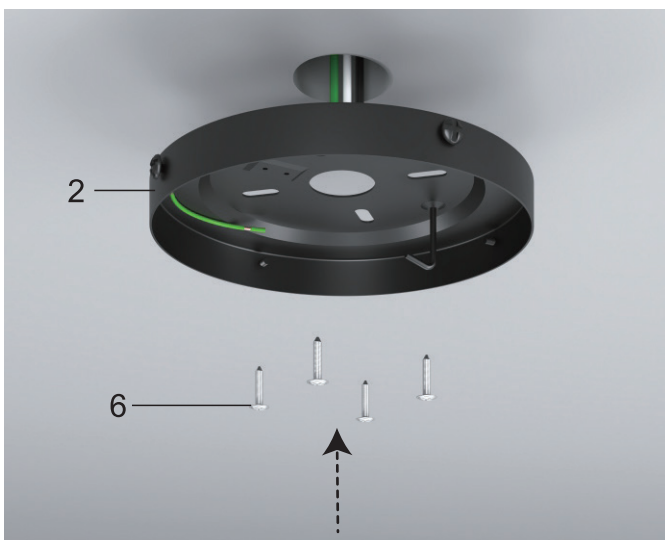

05 Accessory drawing

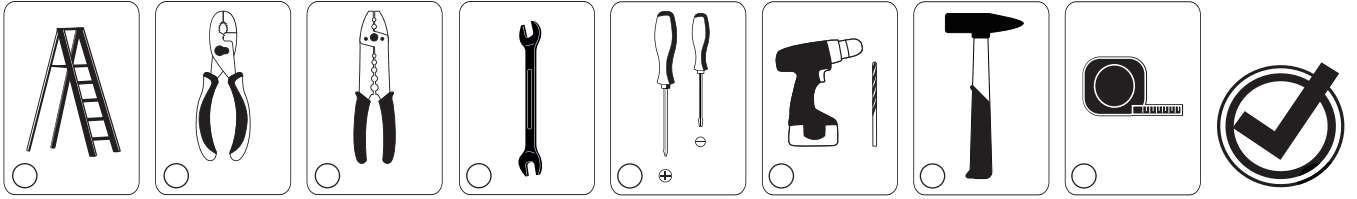

06 Installation procedure

Install the blades

1. Put the blade washers onto one blade and align the holes; Insert the blade screws into the holes



2. Attach this blade using the blade screws and partially tighten the blade screws

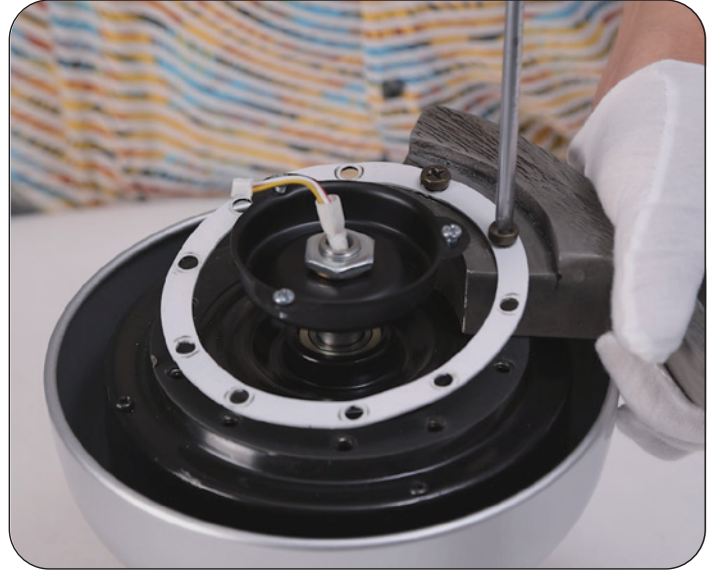

3. Repeat install the five blades



4. Tighten all the blades screws



06 Installation procedure

Install the light plate

5. Loosen the two light kit screws pre-locked on the motor and remove the third light kit screw; It does not matter which two screws you choose

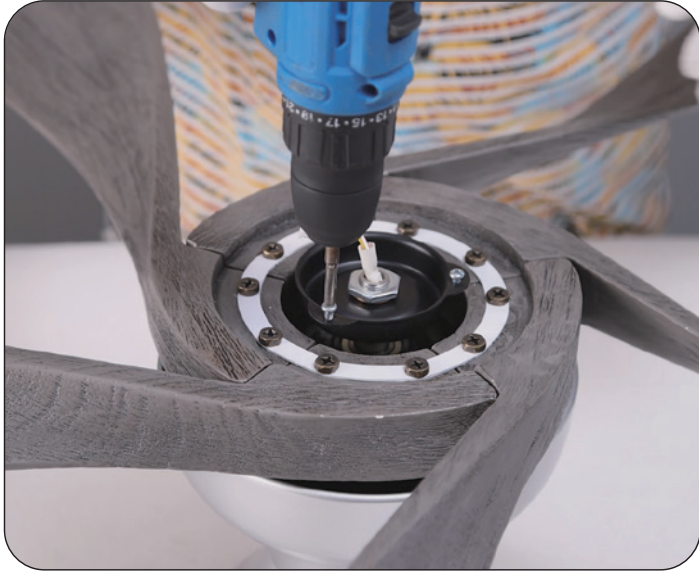

6. Feed the wire plugs through the center hole; Wrap keyhole slots around the screws and twist clockwise



7. Insert the third light kit screw, and then tighten all three light kit screws



8. Remove the other three light kit screws on light plate



06 Installation procedure

9. Connect the light source with the wires from the motor



10. Insert three light kit screws, and then tighten them



Wire the fan



WARNING: Turn off the electric power during installation and making wire connection.

If you are unfamiliar with wiring or uncomfortable doing it yourself, please contact a qualified electrician.

1. Connect the wire which from ceiling fan into the receiver.
2. Connect the wire from receiver with the wire from house.

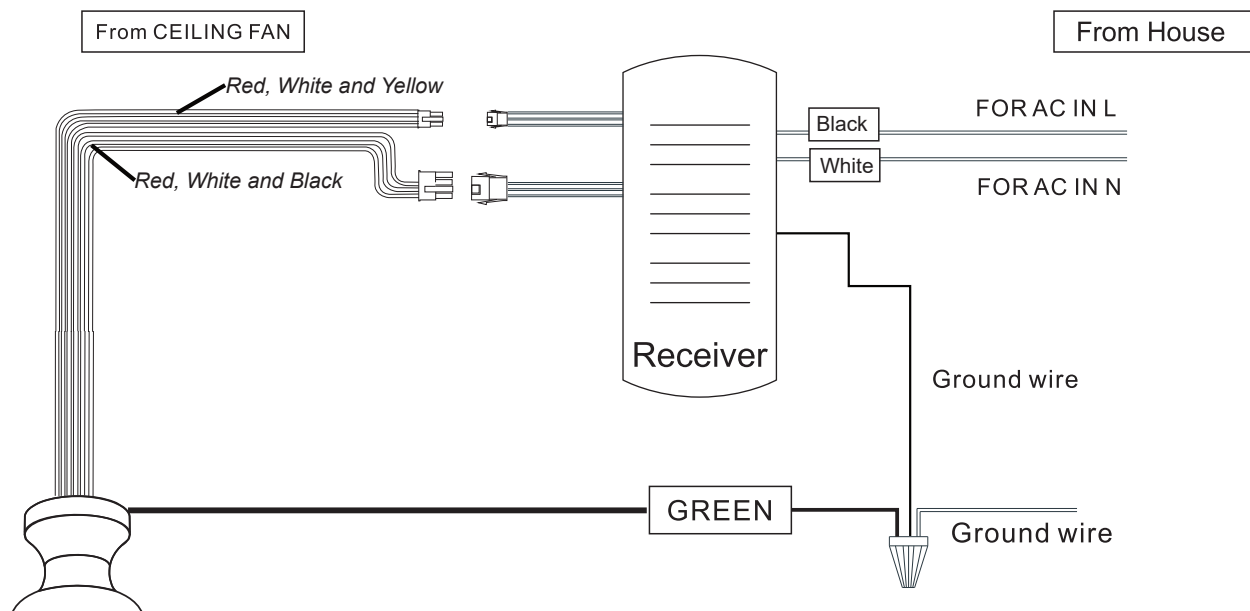

06 Installation procedure

11. Connect the wire from the ceiling fan to the receiver (Red, White and Yellow wires)



12. Connect the wire from the ceiling fan to the receiver (Red, White and Black wires)



13. Place the receiver inside the canopy



06 Installation procedure

Install the ceiling bracket for wooden ceiling

Is your ceiling different? Check out the guide at the page of 3.

14. Install the ceiling bracket with four screws



15. Remove two canopy screws



Hook the wire into the hook of the ceiling plate. Tighten the rope. Tighten the screw.

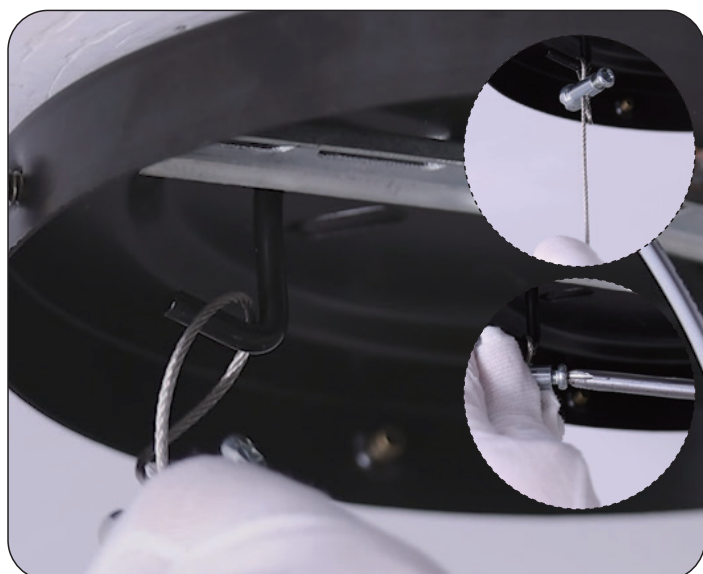

17. Connect the live wire (black) coming from the receiver and house; Connect the neutral wire (White) coming from the receiver and house



06 Installation procedure

Install the Fan Body

18. Place the receiver inside the canopy



19. Lift the fan body from the hook with your hands



20. Align the hanging slots on both sides of the fan body with the two partially installed canopy screws



21. Slide the two slots on both sides of the fan body between the head of the screws and rotate the fan body clockwise so the screws hold the fan body firmly in place



06 Installation procedure

22. Insert two screws and tighten four screws securely



Install the lampshade

23. Install the lampshade and rotate it to lock



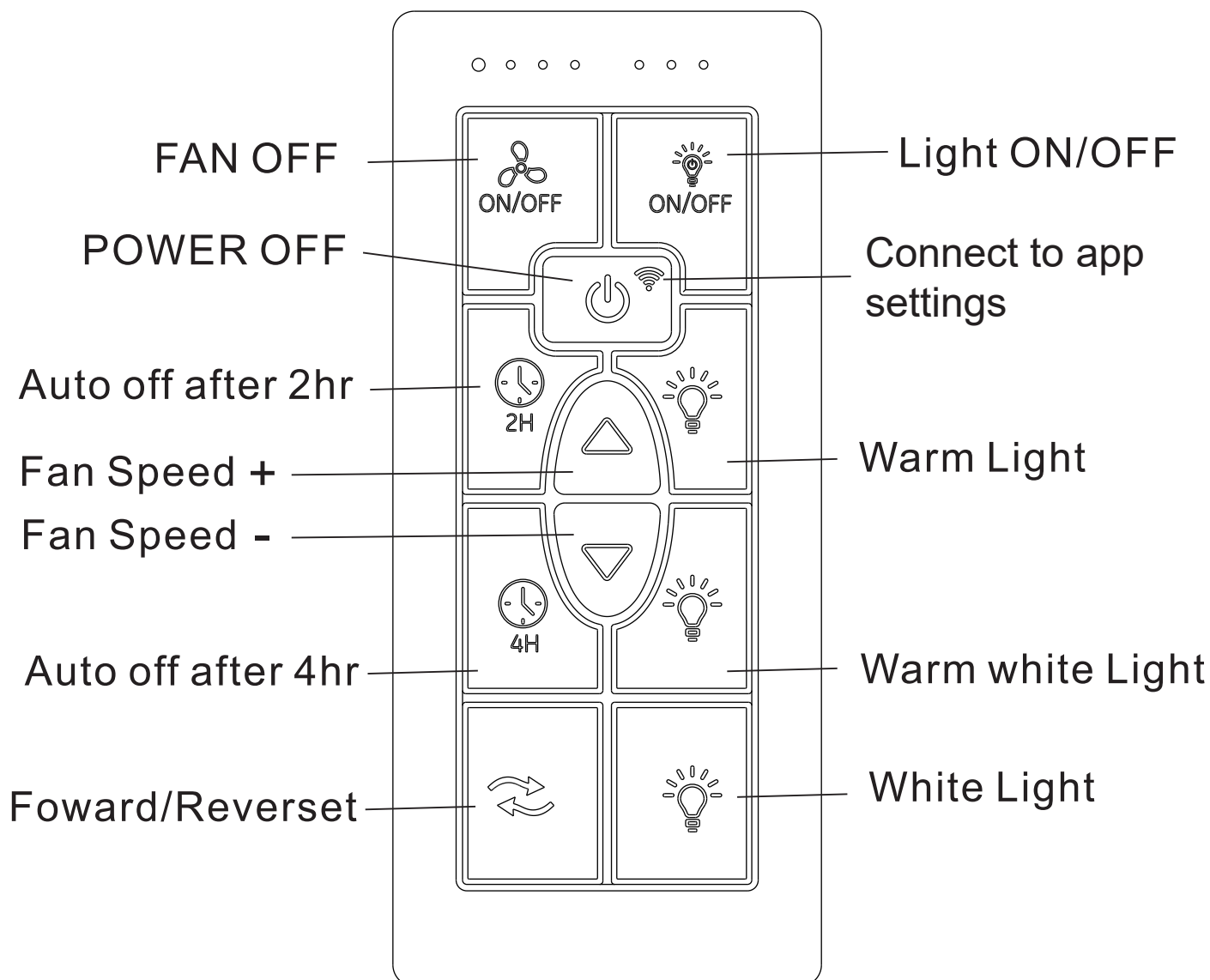

Connect to app settings:

If you power on the fan for more than 3 minutes, you will not be able to search for the device. At this time, you need to reset your fan: turn fan power Off and back on at the wall switch, within 30 seconds, press the "POWER" button for 5 seconds to reset. If the reset is successful, the light flashes, then add the Device again.



After the reversible button is pressed, the fan slowly slows down to a stop. And then it started to reverse.

08 Match code



1. Turn on the main switch.

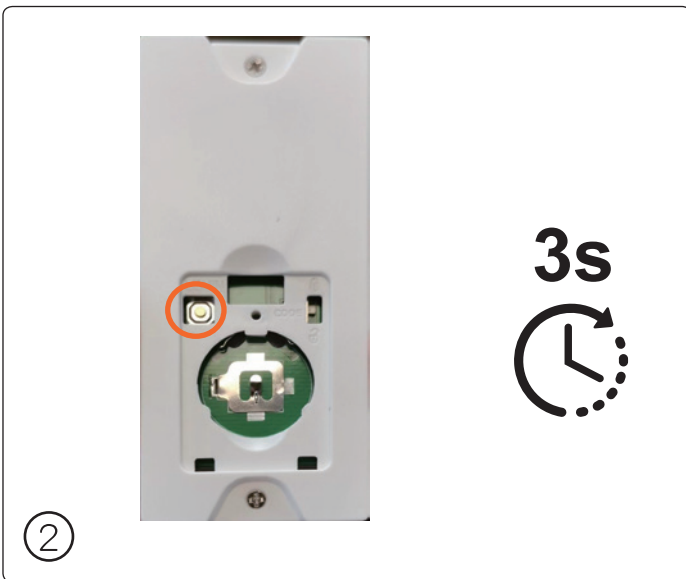

2. Setting the codes on the receiver:
The Learn Key must be pressed with in 5 seconds, after pressing the Power button.
If not, please press the Power button to restart. Keep pressing the button LEARN key in excess of 3 second it becomes a LEARN status.



3. The receiver Can remember the last codes status.
The ceiling fan light flash two times.

09 Fans Balance

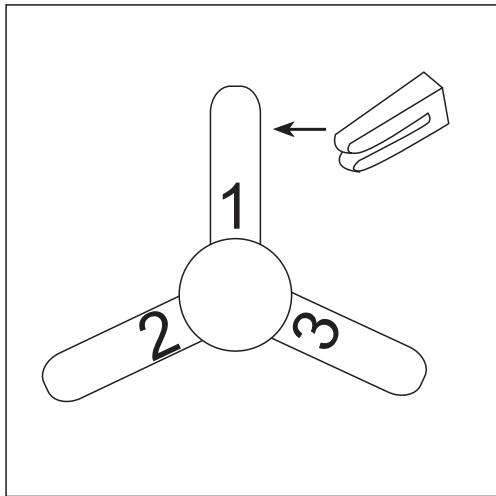

Slide the balancing clip on the trailing edge of any blade, halfway between the holder and tip. Run the fan to check the wobble. If the wobble persists, repeat with each blade, noting which one most reduced the wobble.

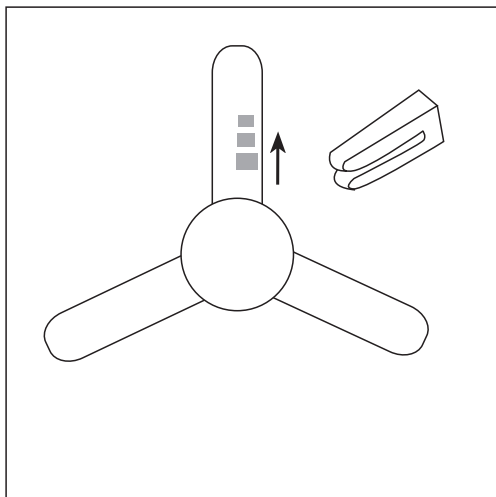

Slide the clip in small increments away from the center of that blade. Move the clip, operate the fan, then move it again until you eliminate as much wobble as possible.

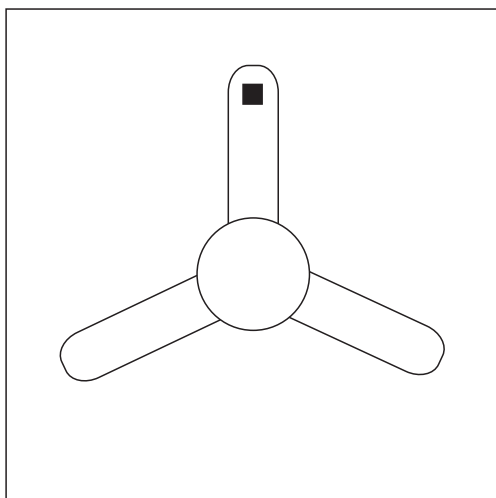

Stick the adhesive-backed balancing weight on the top center of the blade directly in line with the balancing clip. Add more weight if needed to get a smooth-running fan.

10 Care and Cleaning



WARNING: Make sure the power is off before cleaning your fan.

- Because of the fan's natural movement, some connections may become loose. Check the support connections, brackets, and blade attachments twice a year. Make sure they are secure. It is not necessary to remove the fan from the ceiling.
- Clean your fan periodically to help maintain its new appearance over the years. Do not use water when cleaning, as this could damage the motor, or the wood, or possibly cause an electrical shock. Use only a soft brush or lint-free cloth to avoid scratching the finish. The plating is sealed with a lacquer to minimize discoloration or tarnishing.
- You can apply a light coat of furniture polish to the wood for additional protection and enhanced beauty. Cover small scratches with a light application of shoe polish.
- You do not need to oil your fan. The motor has permanently-lubricated sealed ball bearings.

11 Trouble shooting

Problem	Solution
The fan will not start.	<ul style="list-style-type: none"> □ Check the main and branch circuit fuses or breakers. □ Check the line wire connections to the fan and switch wire connections in the switch housing.
The fan is noisy.	<ul style="list-style-type: none"> □ Ensure all motor housing screws are snug. □ Ensure the screws that attach the fan blade bracket to the motor hub are tight. □ Ensure the wire nut connections are not ratting against each other or the interior wall of the switch housing. □ Allow a 24-hour "breaking in" period. Most noises associated with a new fan disappear during this time. □ If you are using the Ceiling Fan light kit, ensure the screws securing the glassware are tight. Check that the light bulbs are also secure. □ Ensure the canopy is a short distance from the ceiling. It should not touch the ceiling. □ Ensure your outlet box is secure and rubber isolator pads were used between the mounting plate and outlet box.
The fan wobbles.	<ul style="list-style-type: none"> □ Please check and follow the instructions: Chapitre No.12 Fan balance on page 13.

Connecting Smart Systems User Manual

1. Connecting with Moble Phone APP

Search for “Smart Life” in the App store or scan the QR code to download the “Smart Life” app

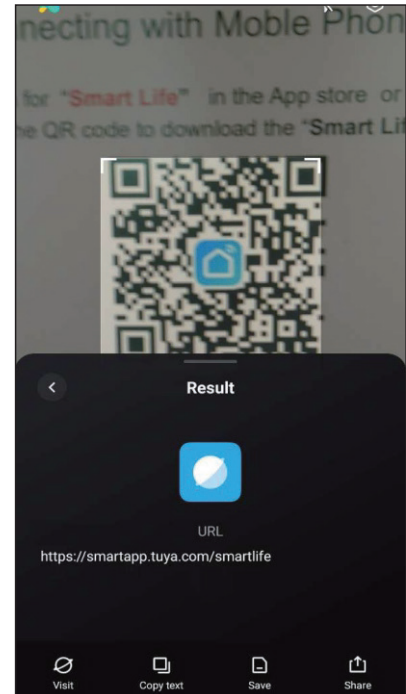

2. Register and log in APP

After downloading and opening the APP, register and log in the APP according to the options.

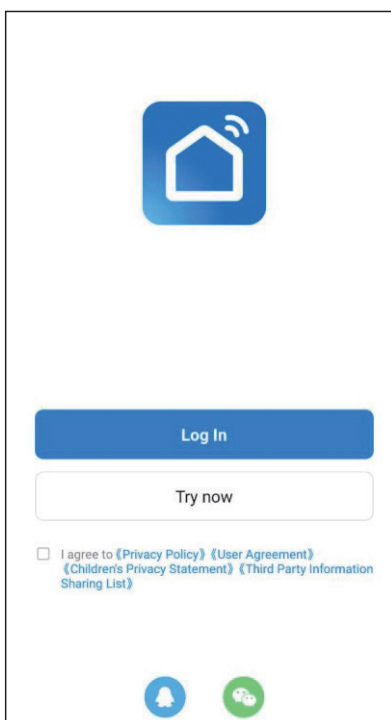

3. Add smart devices

Add smart devices, and ensure WIFI 2.4GHz and Bluetooth are stably connected in subsequent scanning and connection. 5GHz and 5.8GHz are not supported.

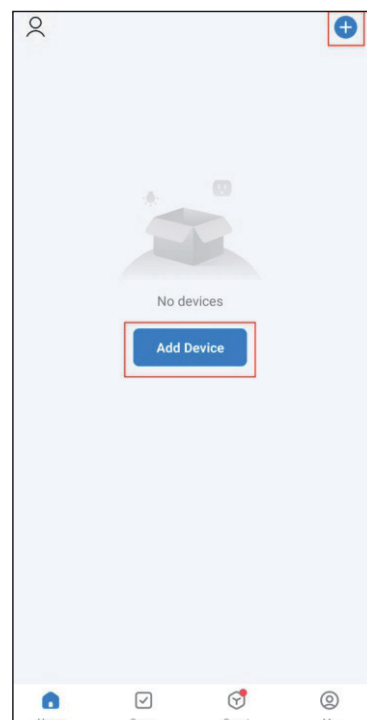

4. Initial automatic scan for connected devices

Within 30 seconds after the fan is powered on, hold down the remote fan switch for 5S, the LED light source blinks once, and the fan is turned on intelligently.

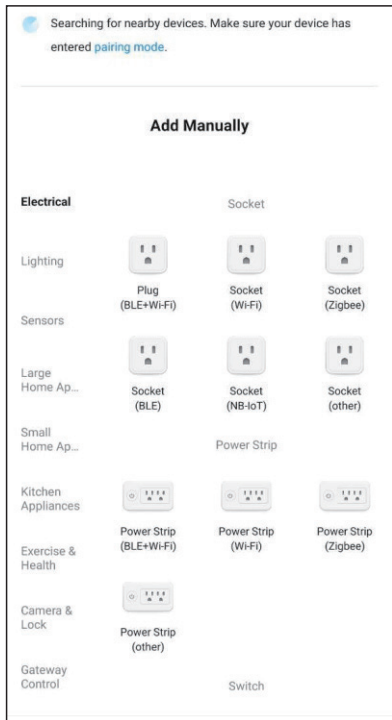

5. Select the scanned fan

Select the fan to be connected.

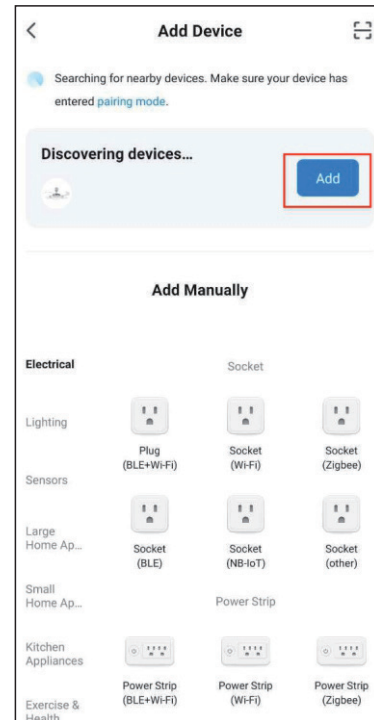

6. APP connection to WIFI

Enter the connected WIFI name and password.

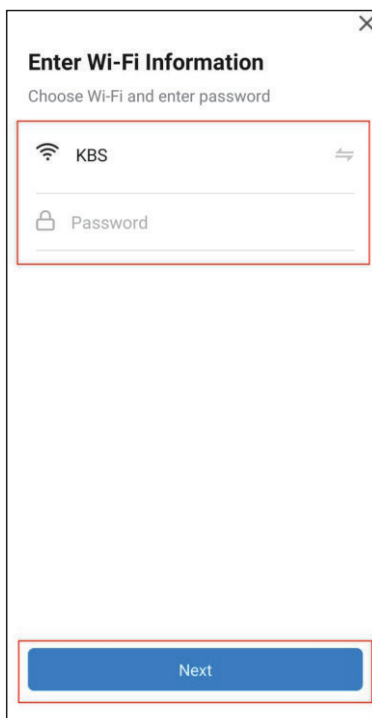

7. The fan is paired with the APP

- ① After pairing is complete, you can customize the fan name.
- ② If pairing fails, first check whether the connected WIFI name and password are correct. If the connection fails for many times, you can try to manually find the fan and select 8 to start.

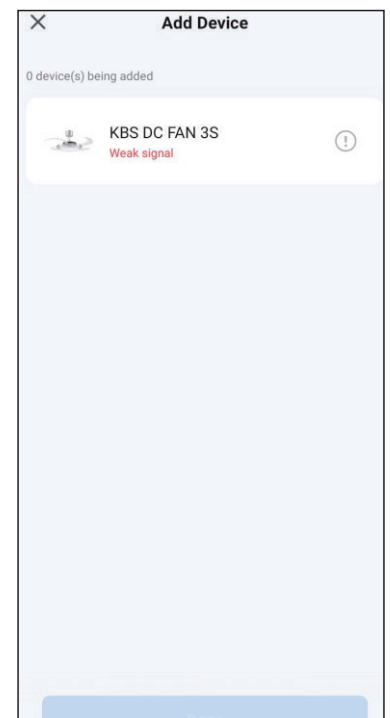
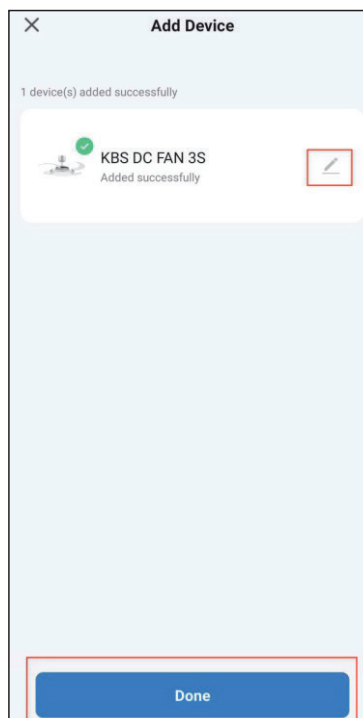

8. Open the fan connection manually

Select "Fan" in "Lighting" (Bluetooth +WIFI).

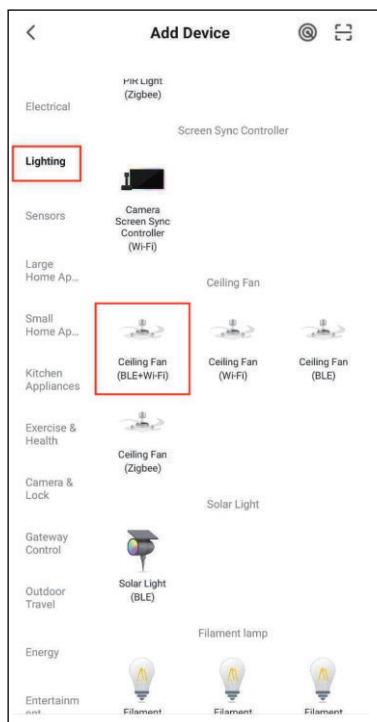

8-1. Follow the prompt

- ① Confirm the indicator is blinking or breathing.
- ② Select the status of the indicator light.

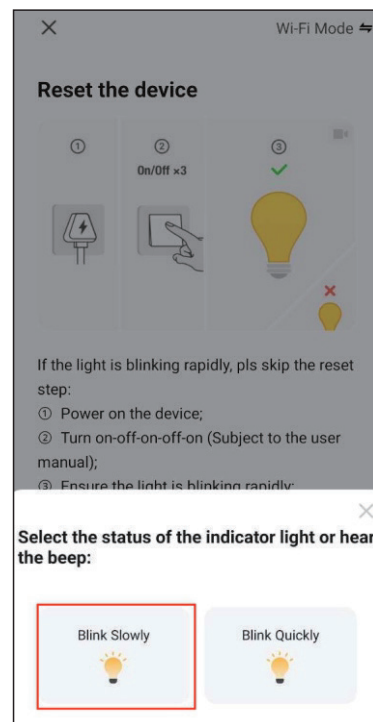
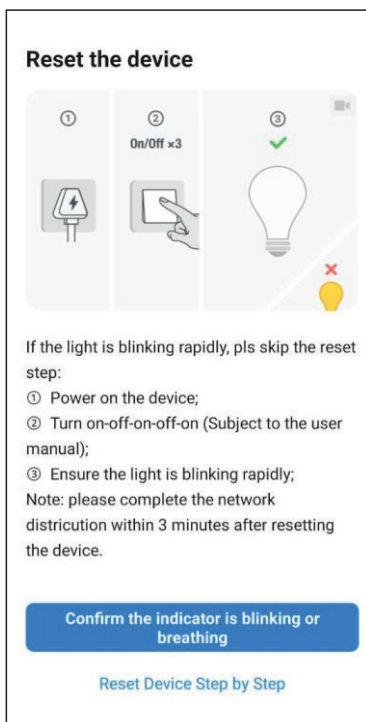

8-1. Follow the prompt

- ① Select 2.4 GHz Wi-fi Network and enter password.
- ② Connect your mobile phone to the device's hotspot.
- ③ Device Adding Timeout, Check demerit points and retry.
- ④ Follow the picture instructions to set up the device.

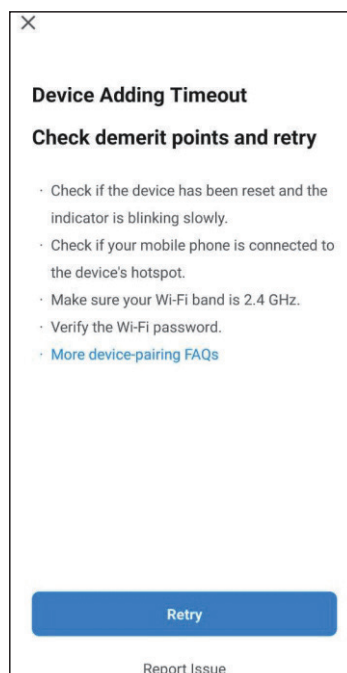
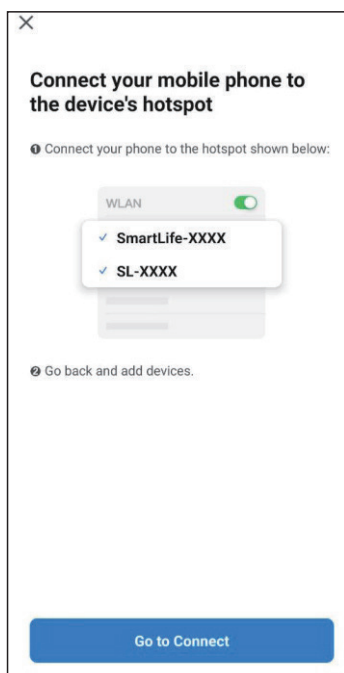
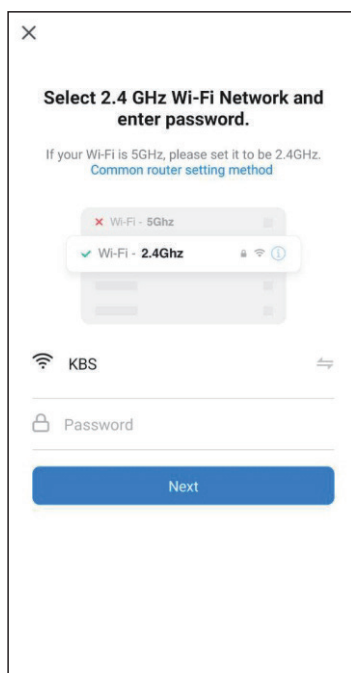

8-2. Manually finding a fan is complete

Manually find the fan successfully, start the connection (refer to 7).

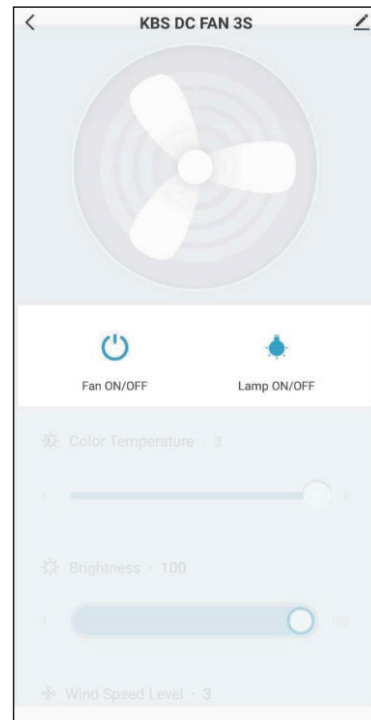
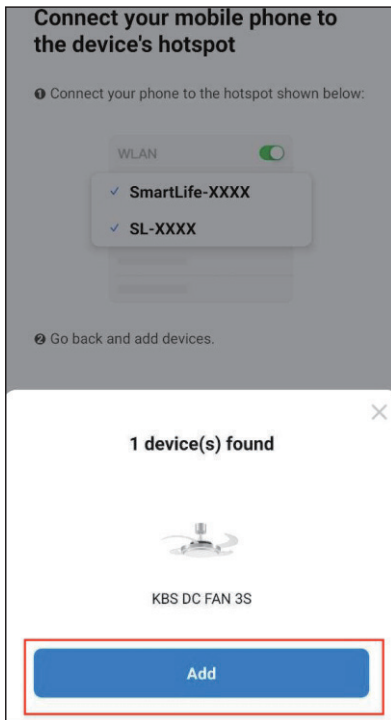

9. Connect successfully and enter the control interface

According to the interface, free adjustment.

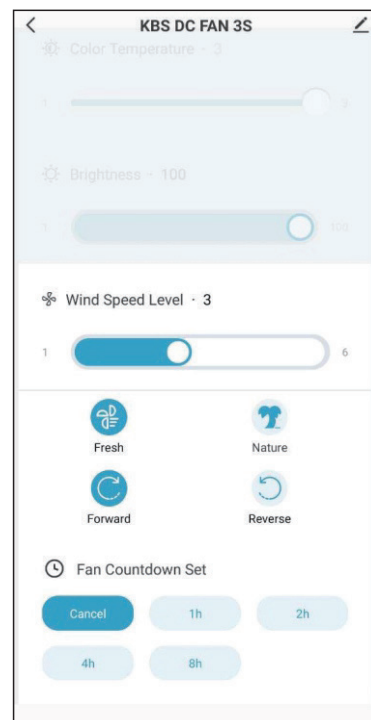
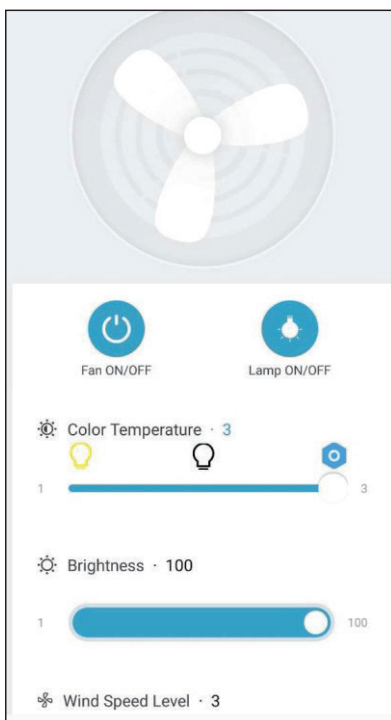

Link skill to the Amazon Echo or Google Assistant

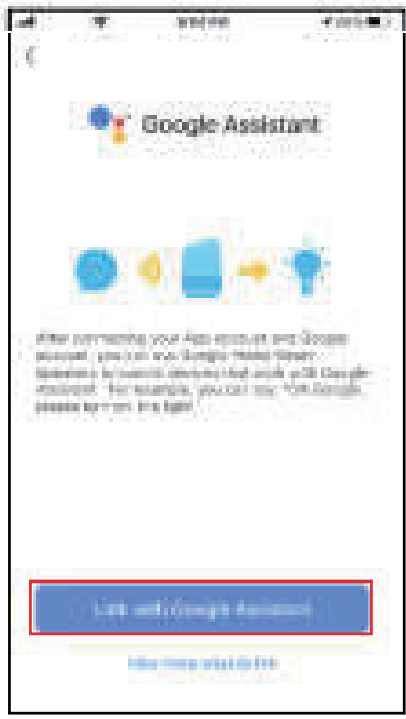

In the App, change the name of the device to an easily identifiable name such as bedroom light, bedroom fan.

Make sure your Amazon Echo device is powered on and connecting to your home Wi-Fi network.

Common commands

- △ Fan: <DEVICE NAME>
- Alexa, tum on/off <DEVICE NAME>.
- Alexa, what is the <DEVICE NAME> speed?
- Alexa, set the <DEVICE NAME> speed to 1/2/3/4/5/6.
- Alexa, setthe bedroom <DEVICE NAME> speed to max.
- Alexa, turn up/decrease the bedroom <DEVICE NAME> speed
- Alexa, set the <DEVICE NAME> to foward/reverse.
- Alexa, is <DEVICE NAME> on on?
- Alexa,set the mode on the <DEVICE NAME> to fresh/nature.
- Alexa,set the count down on the <DEVICE NAME> to cancel/1 hour/2 hour/4 hour/8 hour.
- △ Light: <device name>
- Alexa, tum on/off <device name>.
- Alexa, set the <device name> to fifty percent.
- Alexa, make the <device name> warm white/white/cool white.
- Alexa, brighten/dim <device name>.

