

# INSTALLATION MANUAL

## MIRROR SHOE (STORAGE) CABINET

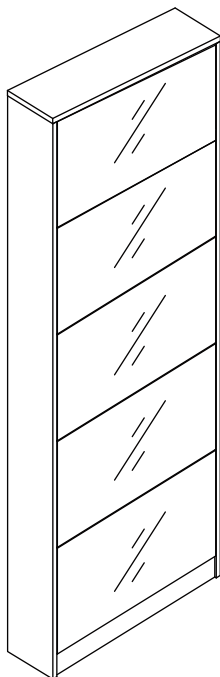

Color : Black / White / Brown

**PLEASE READ** this sheet prior to assembly to familiarise yourself with the various stages of construction. Carefully open the pack supplied and check the contents against the parts and fittings check list. Do not destroy any of the packaging until you are certain that you have all the necessary parts for the assembly.

### SAFETY WARNINGS

**⚠ CHOKING/SUFFOCATION RISK**

Keep small parts away from young children.

**⚠ ASSEMBLY PRECAUTIONS**

Assemble on soft surface to prevent scratches

### Tools Required

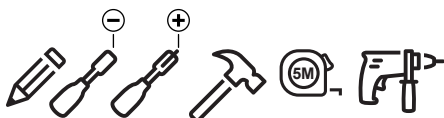

### Person Required



### Approximate Assembly Time



2 Hours

# **SUMMARY**

**INTRODUCTION** page 3

**TIPS AND WARNINGS** page 4

**PARTS LIST** page 5

**INSTALLATION STEPS** page 8

# INTRODUCTION

Read this manual in full before assembly and retain for future reference.

Do not use the product until assembly is complete.

To avoid any injury or damage to the product, please follow below safety rules.

- Product to be installed in a dry, flat place indoor.
- Assembly & movement: minimum 2 adults - heavy and fragile product.
- Make sure all screws in the part list included in the hardware package before assembly.
- In the event of a missing items, contact the seller within 48 hours of receiving the product.

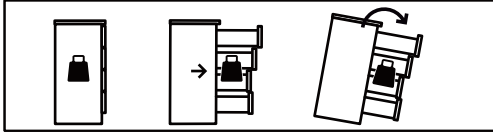

## WARNING

Serious or fatal crushing injuries can occur from furniture tip-over.

ALWAYS secure this furniture to the wall using tip-over restraints.

To further reduce the risk of serious injury and death from tip-overs:

-Place heaviest items in the lower drawer.

-Do not set TVs or other heavy objects on top of this product.

-Never let children climb or hang on drawers, doors or shelves.

### **ATTENTION**

This product is for household use only! And not for commercial use.

Do not use this product for any other over expected purpose. To any commercial use, public or institutional, disclaims all liability and cancels all guarantees.

## TIPS AND WARNINGS:

- Do not lean on the shoe cabinet.
- Do not store in a damp room or outdoor.
- Beware of the risks of pinching and puncturing during installation.
- Beware of the risk of mirror damage.

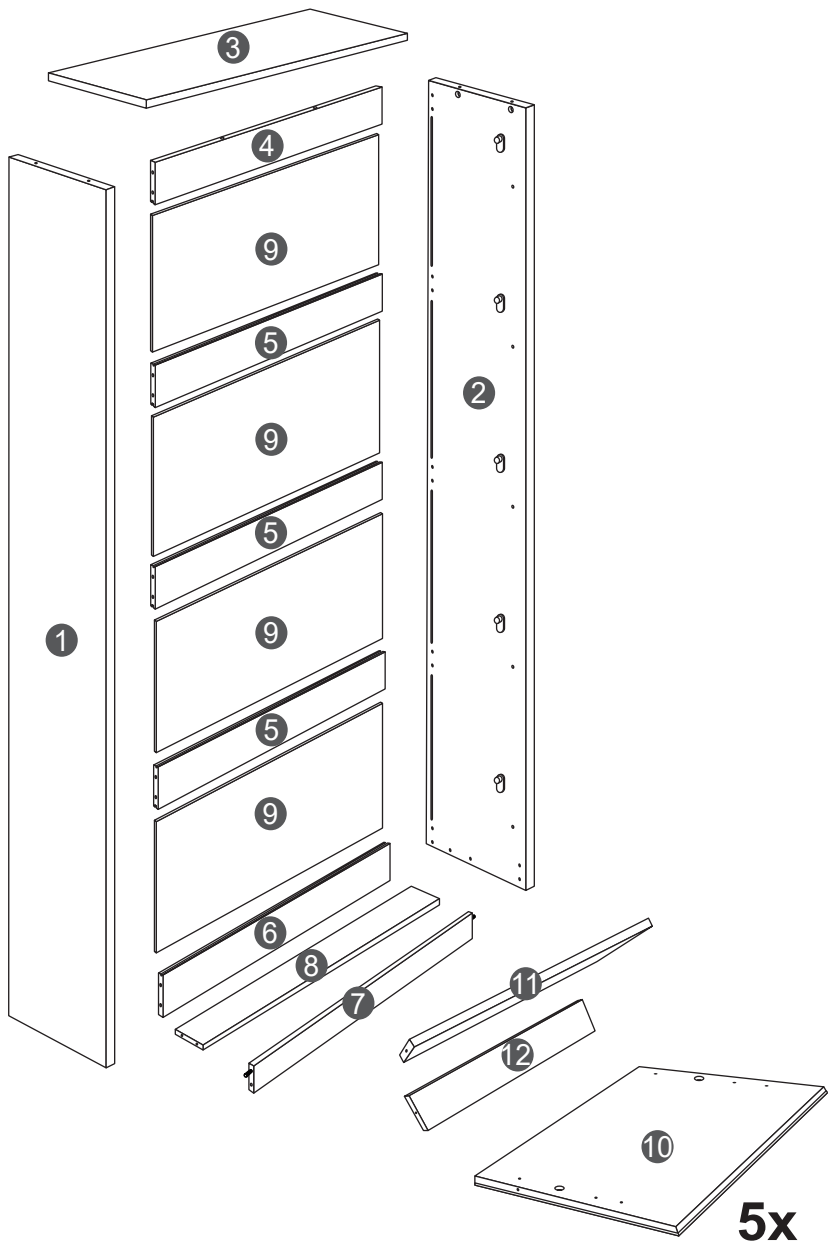

## Maintenance :

- Cleaning with a dry cloth.
- Far away from water or wet shoes.

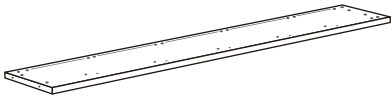
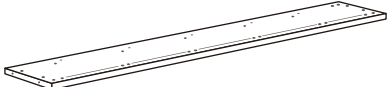

Please check the pack contents before assembling the product. If any components are missing, please contact your retailer. The fittings pack contains small items that should be kept away from small children.

## Components Panels

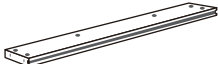
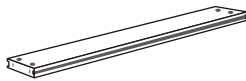
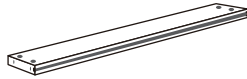
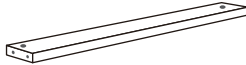
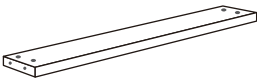
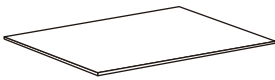
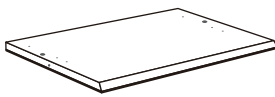
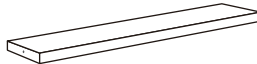
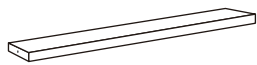
CODE	Panels Name	QTY	
①	Side Panel (L) 1835x196x15mm	1	
②	Side Panel (R) 1835x196x15mm	1	
③	Top Panel 631x196x15mm	1	
④	Back Bar Support 600x90x15mm	1	
⑤	Back Bar Support 600x90x15mm	3	
⑥	Back Bar Support 600x90x15mm	1	
⑦	Front Bar Support 600x66x15mm	1	
⑧	Rear Bar Support 600x98x15mm	1	
⑨	Back Panel 610x356x5mm	4	
⑩	Mirror Door 595x350x12mm	5	
⑪	Door Back Panel 585x128x12mm	5	
⑫	Door Bottom Panel 585x80x12mm	5	

## Components Fittings

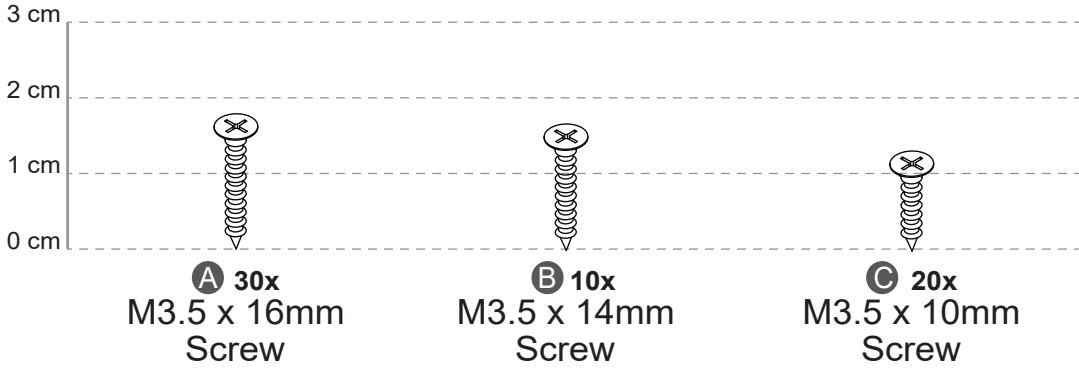

## Components Fittings

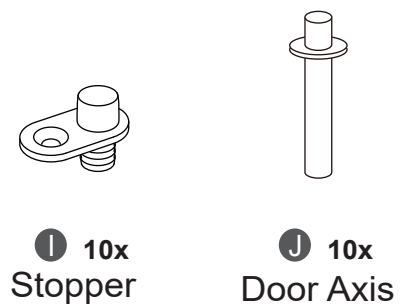
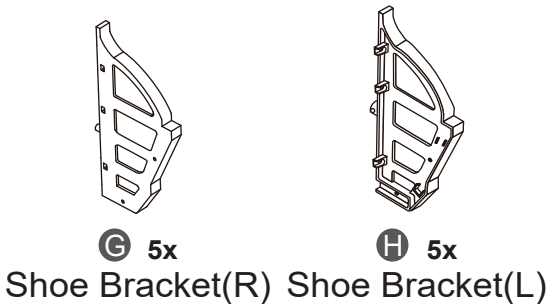
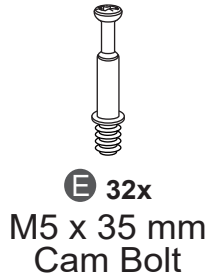
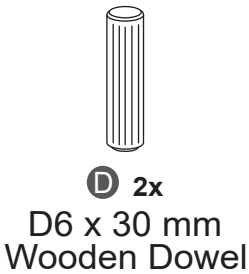



**K** 2x

L Mounting  
Bracket



**L** 2x

Wall Anchor M3.5 x 25 mm



**M** 2x

Screw



**N** 4x

Washer



**O** 2x

M3.5 x 14mm  
Screw

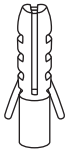

**P** 4x

Wall Anchor M3.5 x 35 mm

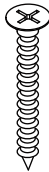

**Q** 4x

M3.5 x 35 mm  
Screw



**R** 4x

M3.5 x 14mm  
Screw

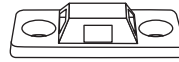

**S** 4x

Anti -tip Kit

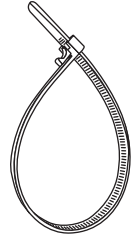

**T** 2x

Wall Strap

## Layout Parts on Soft Surface

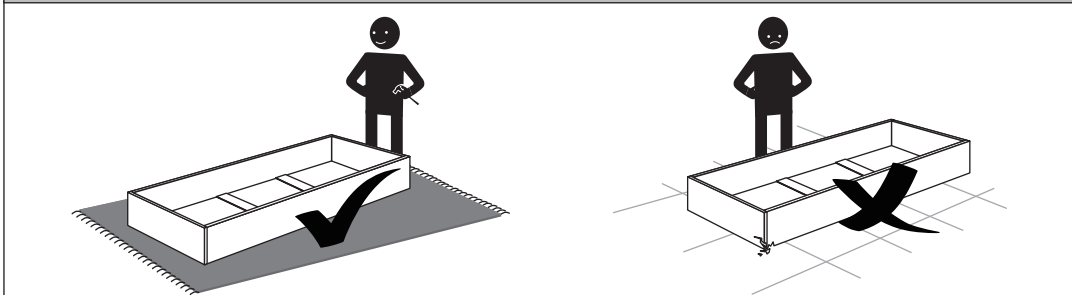

## INSTALLATION STEPS

Please read the instructions carefully before assembling the cabinet.

Two adults are required for assembly of this product on a clean, flat surface instead of a rough surface.

### STEP 1

G

5x

H

5x

A

30x

C

20x

J

10x

10

5x

11

5x

12

5x

C

Center

C

Center

X5

## STEP 2

**Don't screw too deep**

**E** 32x

**I** 10x

**B** 10x

**1** 1x

**2** 1x

**3** 1x

## STEP 3

**Don't screw too deep**

**F** 5x

**D** 2x

**1** 1x

**6** 1x

**7** 1x

**8** 1x





**⚠ ATTENTION ⚠**

Place the installed shoe cabinet flat on the ground then raise it up using two people. Mirror must on the top when you raise it up. Do not let the moveable door panel fall off.

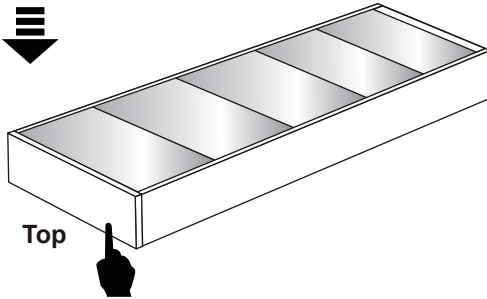
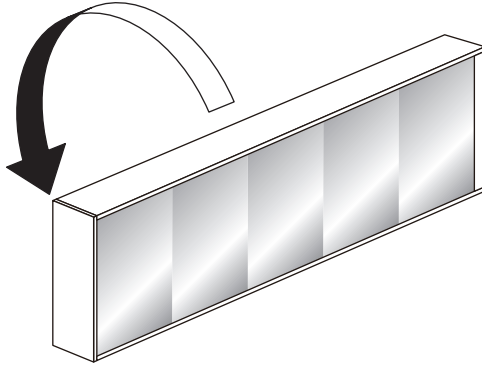

**Bottom**

**Top**

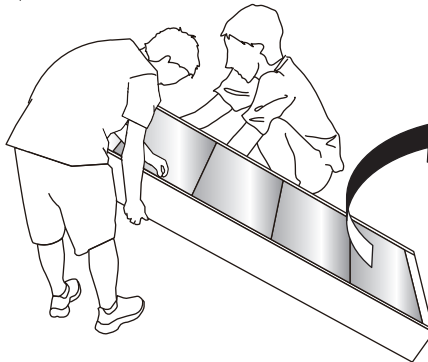

**This side up**

# STEP 10

## ⚠ ATTENTION ⚠

To prevent injury or property damage from the unexpected tip of furniture, we highly recommend installing the anti-tip kit.  
Always ensure the wall area to be drilled is free of electrical wires, water and gas pipes.  
The wall all fixings supplied are suitable for solid walls.  
For other types of wall suitable fixings must be obtained separately.  
If in doubt please consult a qualified tradesperson.

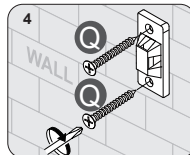
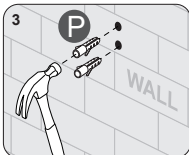
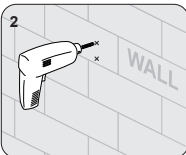
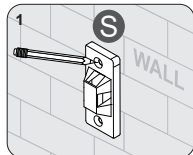



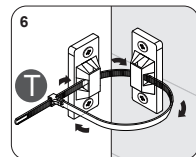
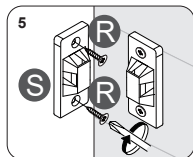

1 Mark the position of anti-tipping kit on the wall, drill and insert the wall anchor.

4 Screw the anti-tipping kit on the wall.



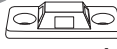



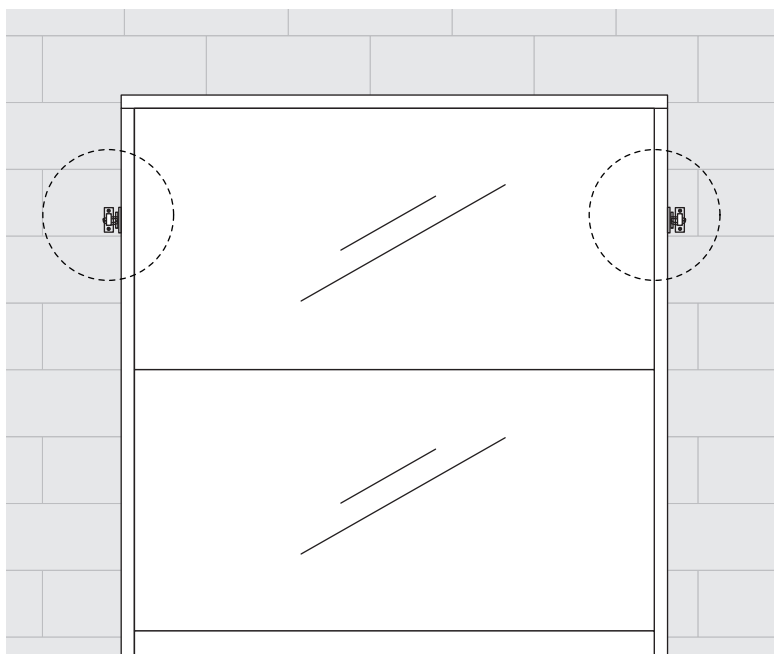

5 Strap together installed anti-tipping on the wall and on the product.  
6 Ensure that it is tight enough to prevent tipping.

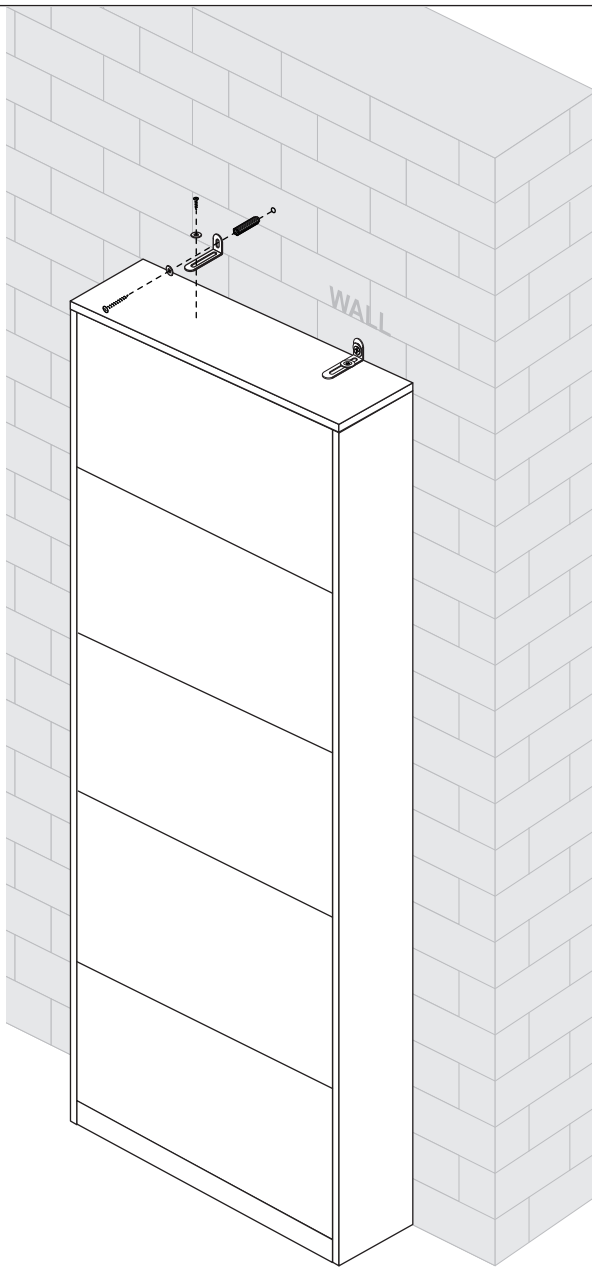
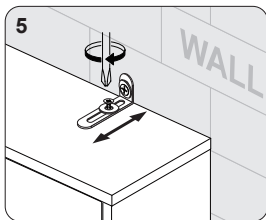
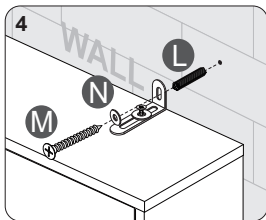
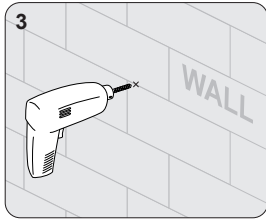
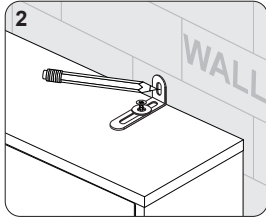
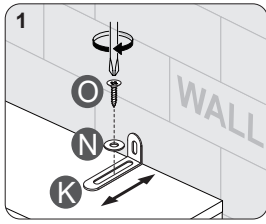
- P**  4x
- Q**  4x
- R**  4x
- S**  4x
- T**  2x



# STEP 11



- K**  2x
- L**  2x
- M**  2x
- N**  4x
- O**  2x

Keep instructions for future reference

