

1.

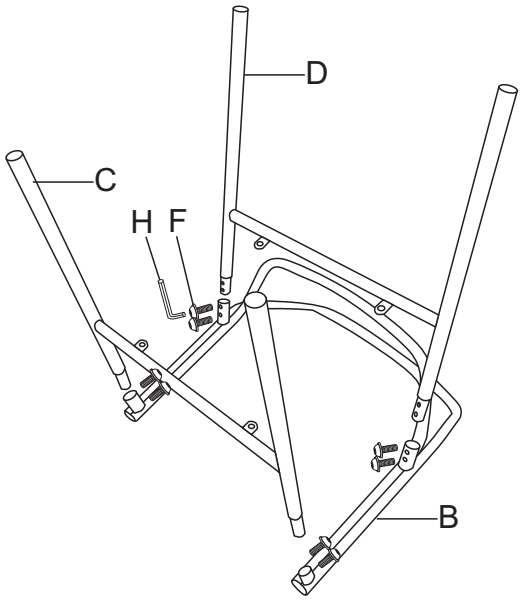

2.

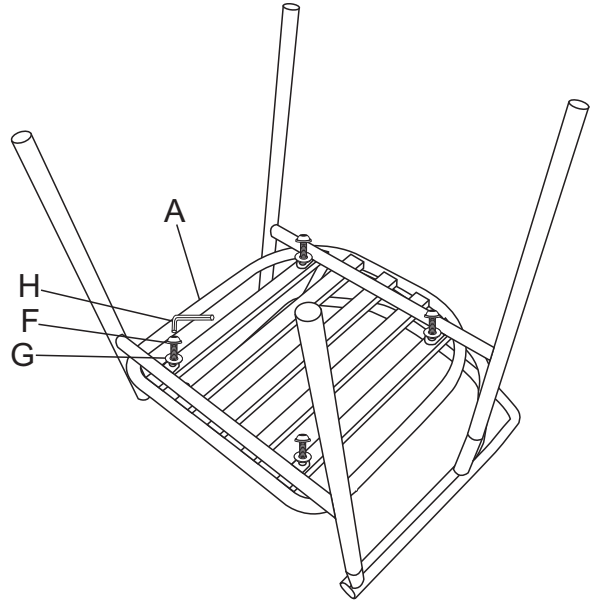

3.

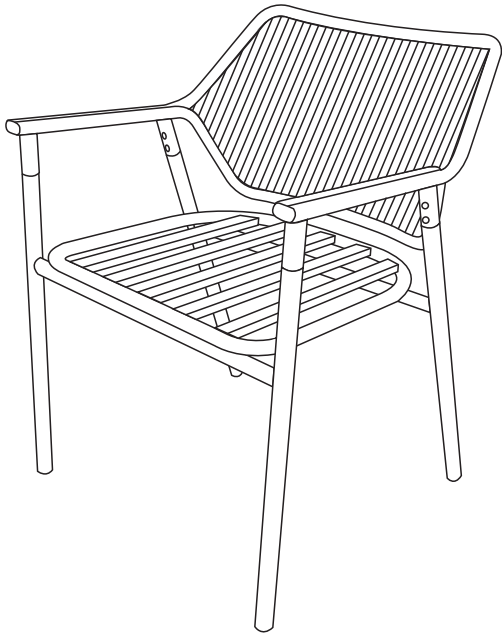

4.

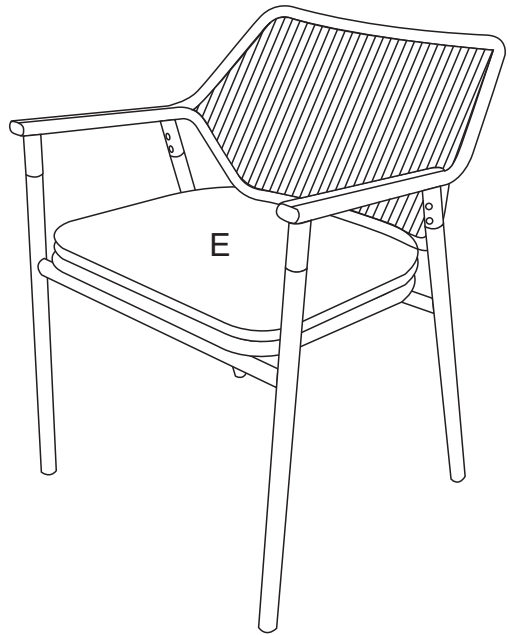

Ax1

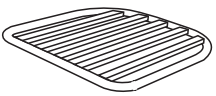

Bx1

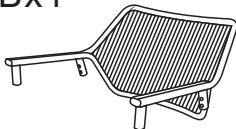

Cx1

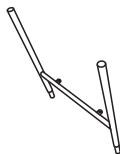

Dx1



Ex1



Fx12



M6x12mm

Gx4



Hx1

