

Displacement : 52cc/58cc/62cc  
Rated output power : 2.1kw/2.4kw/4.0kw  
Gasolion/2-cycle oil mixing ratio : 25 : 1  
Fuel tank capacity : 550ml  
Oil I tank capacity : 260ml  
Guide bar size : 18" /20" /22"  
Chain pitch : 3/8" /0.325"  
Gross weight : 8kg

## **Caution**

---

**Before using our chain saws, please read this manual carefully to understand the proper use of your unit. keep this manual handy .**

**5200 / 5800 / 6200**

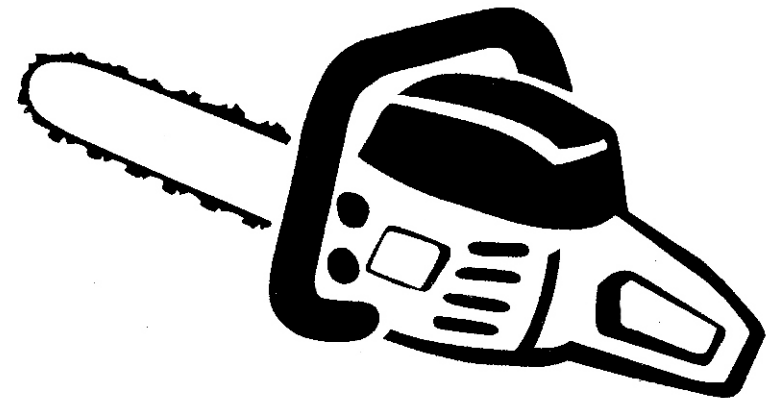

# **CHAIN SAW**



## 11.SPECIFICATIONS

1	Chain saw Model	
2	Mass ( without guide bar and chain)	5.50 (kg)
3	.Dimensions (without guide bar and chain)	410x235x265 (mm)
4	Fuel	Mixture (Gasoline 25: Two-cycle oil 1 )
5	Fuel tank capacity	550 (ml)
6	Chain oil	Motor oil SAE#10W-30
7	Oil tank capacity	260 (ml)
8	Engine displacement	45 (cm <sup>3</sup> )
9	Maximum engine power	1.7 kw/7500rpm
10	Maximum engine speed with cutting attachment	10000rpm
11	Maximum Engine speed at idling	2800rpm
12	Maximum cutting length	38 (cm)
13	Sprocket	7T x 0.325
14	Saw chain type	K2 (CARLTON)
15	Saw chain pitch	0.325 (in)
16	Saw chain gauge	0.058 (in)
17	Guide bar type	Sprocket nose
18	Guide bar size	16, 18, 20 (in)
19	Oil feeding system	Automatic pump with adjuster

NOTICE: Specifications are subject to change without notice.

## SAFETY FIRST

Instructions contained in warnings within this manual marked with a  symbol concern critical points which must be taken into consideration to prevent possible serious bodily injury , and for this reason you are requested to read all such instructions carefully and follow them without fail.

### ■ NOTES ON TYPES OF WARNINGS IN THE MANUAL

#### WARNING

This mark indicates instructions which must be followed in order to prevent accidents which could lead to serious bodily injury or death.

#### **IMPORTANT**

This mark indicates instructions which must be followed, or it leads to mechanical failure, breakdown, or damage.

#### **NOTE**

This mark indicates hints or directions useful in the use of the product.

## Contents

1. PARTS LOCATION.....	2
2. WARNING LABELS ON THE MACHINE.....	2
3. SYMBOLS ON THE MACHINE.....	3
4. SAFETY PRECAUTIONS.....	3
5. INSTALLING GUIDE BAR AND SAW CHAIN.....	7
6. FUEL AND CHAIN OIL.....	9
7. OPERATING ENGINE.....	10
8. SAWING.....	14
9. MAINTENANCE.....	16
10. MAINTENANCE OF SAW CHAIN AND GUIDE BAR.....	18
11. SPECIFICATIONS.....	20

## 1. PARTS LOCATION

1. Front guard
2. Starter knob
3. Air cleaner
4. Choke knob
5. Throttle interlock
6. Rear handle
7. Throttle trigger
8. Throttle lock button
9. Engine switch
10. Fuel tank
11. Oil tank
12. Front handle
13. Saw chain
14. Guide Bar

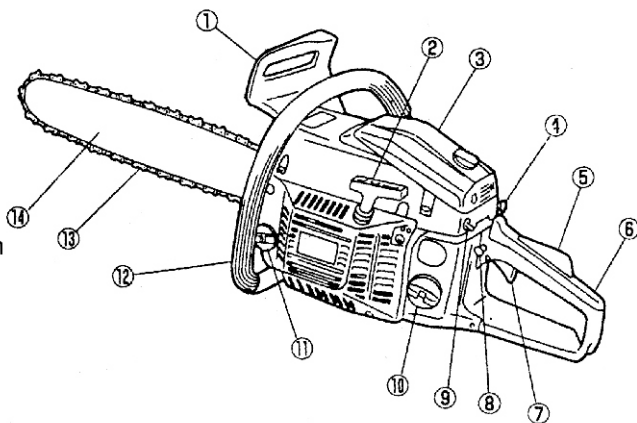

## 2. WARNING LABELS ON THE MACHINE

(1) Read owner's manual before operating this machine.



(2) Wear head, eye and ear protection.



(3) Use the chain saw with two hands



(4) Warning! kickback is danger



(5) Warning/Attention



### IMPORTANT

If warning seals peel off or become soiled and impossible to read, you should contact the dealer from which you purchased the product to order new seals and affix the new seal(s) in the required location(s).

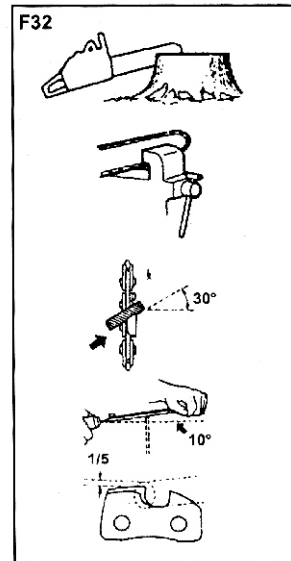

Place your file on the cutter and push straight forward. Keep the file position as illustrated. (F32)

After every cutter has been set, check the depth gauge and file it to the proper level as illustrated. (F33)

### WARNING

Be sure to round off the front edge to reduce the chance of kickback or tie-strap breakage.

- (1) Appropriate gauge checker
- (2) Make the shoulder round
- (3) Depth gauge standard

Make sure every cutter has the same length and edge angles as illustrated (F34)

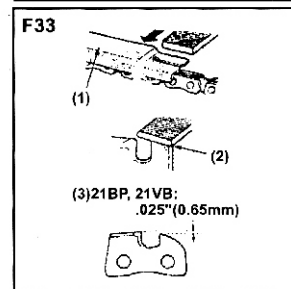

- (4) Cutter length
- (5) Filing angle
- (6) Side plate angle
- (7) Top plate cutting angle

### GUIDE BAR

- Reverse the bar occasionally to prevent partial wear.
- The bar rail should always be a square. Check for wear of the bar rail. Apply a ruler to the bar and the outside of a cutter. If a gap is observed between them the rail is normal. Otherwise, the rail is worn. Such a bar needs to be corrected or replaced. (F35)

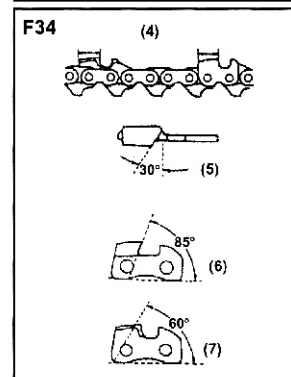

- (1) Ruler
- (2) Gap
- (3) No gap
- (4) Chain tilts

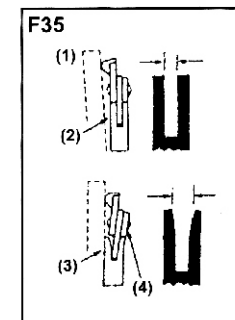

- (2) Needle bearing
- (3) Clutch drum
- (4) Spacer
- (5) Clutch shoe

**4. Fuel filter**

Disassemble the filter and wash with gasoline, or replace with new one if needed.

**5. Oil filter**

Disassemble the filter and wash with gasoline, or replace with new one if needed.

**6. Front and Rear dampers**

Replace if adhered part is peeled or crack is observed on the rubber part.

**10. MAINTENANCE OF SAW CHAIN AND GUIDE BAR.**

**■ SAW CHAIN**

**▲ WARNING**

It is very important for smooth and safe operation to keep the cutters always sharp.

Your cutters need to be sharpened when:

- . Sawdust becomes powder-like.
- . You need extra force to saw in.
- . The cut way does not go straight
- . Vibration increases
- . Fuel consumption increases

**Cutter setting standards:**

**▲ WARNING**

Be sure to wear safety gloves.

- . Before filing:
- . Make sure the saw chain is held securely
- . Make sure the engine is stopped
- . Use a round file of proper size for your chain.

Chain type: 21VB  
File size: 3/16 in (4.76mm)

**▲ WARNING**

Never remodel the product. We won't warrant the machine, if you use the remodeled product or you don't observe the proper usage written in the manual.

**3. SYMBOLS ON THE MACHINE**

For safe operation and maintenance, symbols are carved in relief on the machine. According to these indications, please be careful not to make a mistake.

- (a). The port to refuel the "MIX GASOLINE"  
**Position: fuel tank cap**
- (b). The port to refuel the "CHAIN OIL"  
**Position: oil cap**
- (c). The indication regarding the switch. Flipping the engine switch to the "O" (STOP) direction, the engine stops.  
**Position: rear-left of the unit**
- (d). The indication regarding the choke.  
Pulling out the choke knob, the choke closes.  
**Position: rear-right of the unit**
- (e). The indication regarding the chain oil adjuster nut.  
"MIN" direction-the oil flow decrease  
"MAX" direction-the oil flow increase  
**Position: bottom of the clutch side**
- (f). The position of H-needle  
The position of L-needle  
The position of idle adjusting screw  
**Position: rear-left of the unit**

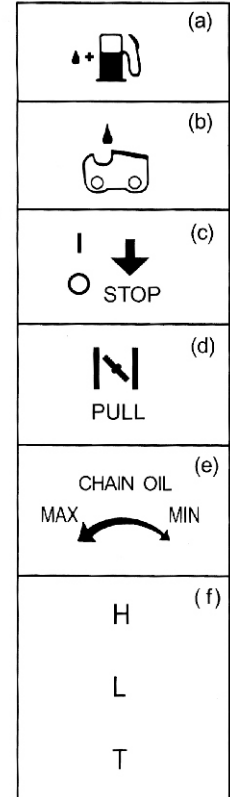

**4. SAFETY PRECAUTIONS**

**■ BEFORE USING THE MACHINE**

- a. Read this owner's manual carefully to understand how to operate this unit properly.
- b. You should never use the product when under the influence of alcohol, when suffering from exhaustion or lack of sleep, when suffering from drowsiness as a result of having taken cold medicine, or at any other time when a possibility



exists that your judgment might be impaired or that you might not be able to operate the machine properly and in a safe manner.

- c. Avoid running the engine indoors. The exhaust gases contain harmful carbon monoxide.
- d. Never use the product under circumstances like those described below:
  1. When the ground is slippery or when other conditions exist which might make it not possible to maintain a steady posture
  2. At night, at times of heavy fog, or at any other times when your field of vision might be limited and it would be difficult to gain a clear view of the area.
  3. During rain storms, during lightning storms, at times of strong or gale-force winds, or at any other times when weather conditions might make it unsafe to use this product.
- e. when using this product for the first time, before beginning actual work, learn to handling it from skilled worker.
- f. Lack of sleep, tiredness, or physical exhaustion results in lower attention spans, and this in turn leads to accidents and injury. Limit the amount of time of using the machine continuously to somewhere around 10 minutes per session, and take 10 ~ 20 minutes of rest between work sessions. Also try to keep the total amount of work performed in a single day under 2 hours or less.
- g. Be sure to keep this manual handy so that you may refer to it later whenever any questions arise.
- h. Always be sure to include this manual when selling ,lending ,or otherwise transferring the ownership of the product.
- i. Never allow children or anyone unable to fully understand the directions given in this manual to use this product.



#### ■ WORKING GEAR AND CLOTHING

- a. When using the product ,you should wear proper clothing and protective equipments as follows.

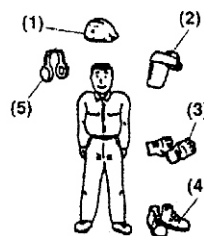

- (1) **Helmet**
- (2) **Protection goggles or face Protector**
- (3) **Thick work gloves**
- (4) **Non-slip-sole work boots**
- (5) **Ear protectors**

- b. And you should carry with you.
  1. Attached tools and files.
  2. Properly reserved fuel and chain oil.

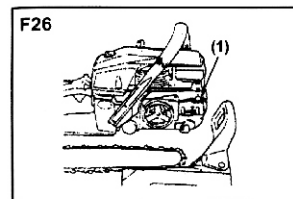

oiling pot for clogging. (F26)

#### 3. Guide bar

When the guide bar is dismounted, remove Saw dust in the bar groove and the oiling port. (F27) Grease the nose sprocket from the feeding port on the tip of the bar. (F28)

- (1) **Oiling port**
- (2) **Grease port**
- (3) **Sprocket**

#### 4. Others

Check for fuel leakage and loose fastenings and damage to major parts.

especially handle joints and guide bar mounting. If any defects are found, make sure to have them repaired before operating again.

#### ■ PERIODICAL SERVICE POINTS

##### 1. Cylinder fins

Dust clogging between the cylinder fins will cause overheating of the engine Periodically check and clean the cylinder fins after removing the air cleaner and the cylinder cover.

When installing the cylinder cover, make sure that switch wires and grommets are positioned correctly in place. (F29)

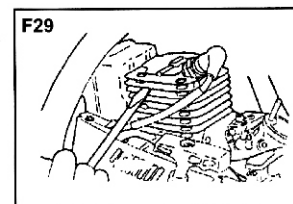
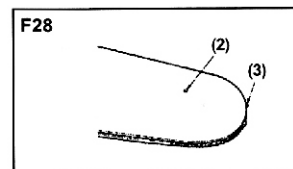
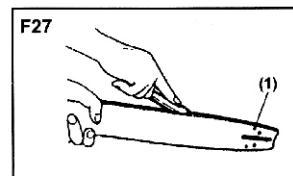

#### NOTE

Be sure to block the air intake hole.

##### 2. Spark plug ( F30 )

Clean the electrodes with a wire brush and reset the gap to 0.65mm as necessary.

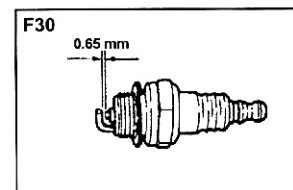

##### 3. Sprocket ( F31 )

Check for cracks and for excessive wear interfering with the chain drive. If the wearing is found obviously, replace it with new one. Never fit a new chain on a worn sprocket, or a worn chain on a new sprocket .

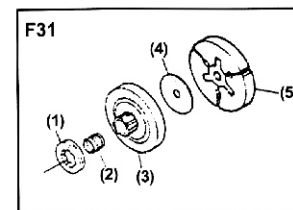

- (1) **Sprocket**

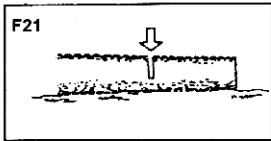

the guide bar from being caught in the cut.

#### A Log lying on the ground (F21)

Saw down halfway, then roll the log over and cut from the opposite side.

#### A Log hanging off the ground (F22)

In area A, saw up from the bottom one-third and finish by sawing down from the top. In area B, saw down from the top one-third and finish by sawing up from the bottom.

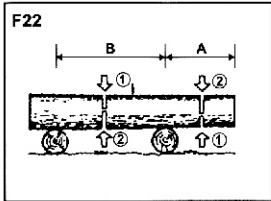

#### Cutting Limb of Fallen Tree (F23)

First check to which side the limb is bent. Then make the initial cut from the bent side and finish by sawing from the opposite side.

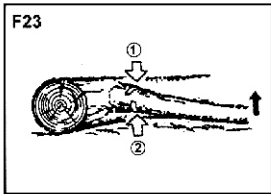

#### ▲ WARNING

Be alert to the springing back of a cut limb. Pruning of Standing Tree (F24)  
Cut up from the bottom, finish down from the top.

#### ▲ WARNING

- Do not use an unstable foothold or ladder.
- Do not overreach.
- Do not cut above shoulder height.
- Always use your both hands to grip the saw.

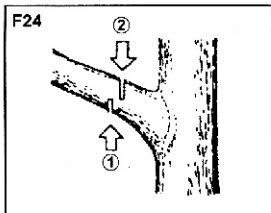

## 9. MAINTENANCE

#### ▲ WARNING

Before cleaning, inspecting, or repairing your unit, make sure that engine has stopped and is cool. Disconnect the spark plug to prevent accidental starting.

#### ■ MAINTENANCE AFTER EACH USE

##### 1. Air filter

Dust on the cleaner surface can be removed by tapping a corner of the cleaner against a hard surface. To clean dirt in the meshes, split the cleaner in two halves and brush in gasoline. When using compressed air, blow from the inside. (F25)

##### 2. Oiling port

Dismount the guide bar and check the

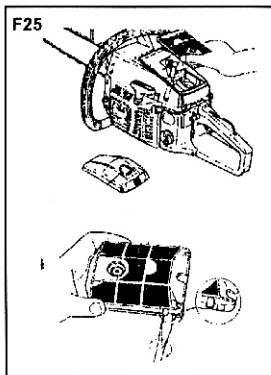

3. Things to notify your working area (Rope, warning signs)
  4. Whistle (for collaboration or emergency)
  5. Hatchet or saw (for removal of obstacles)
- c. Never use the product when wearing pants with loose cuffs, when wearing sandals, or when barefoot.

#### ■ WARNING CONSIDERING HANDLING OF FUEL

- a. The engine of this product is designed to run on a mixed fuel which contains highly flammable gasoline. Never store cans of fuel or refill the fuel tank in any place where there is a boiler stove, wood fire, electrical sparks, welding sparks, or any other source of heat or fire which might ignite the fuel.
- b. Smoking while operating the product or refilling its fuel tank is extremely dangerous. Always be sure to keep lit cigarettes away from the product at all times.
- c. When refilling the tank always turn off the engine first and take a careful look around to make sure that there are no sparks or open flames anywhere nearby before refueling.
- d. If any fuel spillage occurs during refueling, use a dry rag to wipe up spills before turning the engine back on again.
- e. After refueling, screw the fuel cap back tightly onto the fuel tank and then carry the product to a spot 3m or more away from where it was refueled before turning on the engine.



#### ■ BEFORE STARTING ENGINE

- Check working place, the cutting object and cutting direction. If there is obstacle, remove it.
- Never start cutting until you have a clear work area, secure footing and a planned retreat path from the falling tree.
- Use caution and keep bystanders and animals out of the working area whose diameter is 2.5 times of the cutting object.
- Inspect the machine for worn, loose, or damaged parts. Never operate the machine that is damaged, improperly adjusted, or is not completely and securely assembled. Make sure that the saw chain stops moving when the throttle control trigger is released.

#### ■ WHEN STARTING THE ENGINE

- Always hold the machine firmly with both hands when the engine is running. Use a firm grip with thumb and fingers encircling the handles.
- Keep all parts of your body away from the machine when the engine is running.

- Before starting the engine, make sure the saw chain is not contacting anything.



### ■ OPERATION

- Keep the handles dry, clean and free of oil or fuel mixture.
- Never touch the muffler, spark plug or other metallic parts of the engine while the engine is in operation or immediately after stopping the engine. Doing so could result in serious burns or electrical shock.
- Use extreme caution when cutting small size brush and saplings because slender material may catch the saw chain and be whipped toward you or pull you off balance.
- When cutting a limb that is under tension, be alert for spring back to that you won't be struck when the tension in the wood fibers is released
- Check the tree for dead branches that could fall during the felling operation.
- Always shut off the engine before setting it down.

### ■ KICKBACK SAFETY PRECAUTIONS FOR CHAIN SAW USERS

#### ▲ WARNING

- Kickback may occur when the nose or tip of the guide bar touches an object, or when the wood closes in and pinches the saw chain in the cut. Tip contact in some cases may cause a lightning fast reverse reaction, kicking the guide bar up and back towards the operator. Pinching the saw chain along the top of the guide bar may push the guide bar rapidly back towards the operator. Either of these reactions may cause you to lose control of the saw which could result in serious personal injury.
- Do not rely exclusively on the safety devices built into your saw. As a chain saw user you should take several steps to keep cutting jobs free from accident or injury.
  - (1) With a basic understanding of kickback you can reduce or eliminate the element of surprise. Sudden surprise contributes to accidents.
  - (2) Keep a good grip on the saw with both hands, the right hand on the rear handle, and the left hand on the front handle, when the engine is running. Use a firm grip with thumbs and fingers encircling the chain saw handles. A firm grip will help you reduce kickback and maintain control of the saw.
  - (3) Make certain that the area in which you are cutting is free from obstructions. Do not let the nose of the guide bar contact a log, branch, or any other obstruction which could be hit while you are operating the saw.
  - (4) Cut at high engine speed.

- It is extremely important that the chain brake be checked for proper operation before each use and that the chain be sharp in order to maintain the kickback safety level of this saw. Removal of the safety devices. Inadequate maintenance, or incorrect replacement of the bar or chain may increase the risk or serious personal injury due to kickback.

### ■ FELLING A TREE (F20)

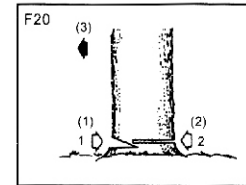

1. Decide the felling direction considering the wind, lean of the tree, location of heavy branches, ease of job after felling and other factors
2. While clearing the area around the tree, arrange a good foothold and retreat path.
3. Make a notch cut one-third of the way into the tree on the felling side.
4. Make a felling cut from the opposite side of the notch and at a level slightly higher than the bottom of the notch.

#### ▲ WARNING

**When you fell a tree, be sure to warn your neighboring workers of the danger.**

- (1) Notch cut
- (2) Felling cut
- (3) Felling direction

### ■ Bucking and Limbing

#### ▲ WARNING

- **Always ensure your foothold. Do not stand on the log.**
- **Be alert to the rolling over of a cut log. Especially when working on a slope, stand on the uphill side of the log.**
- **Follow the instructions in "For safe Operation" to avoid kickback of the saw.**

Before starting work, check the direction of bending force inside the log to be cut. Always finish cutting from the opposite side of bending direction to prevent

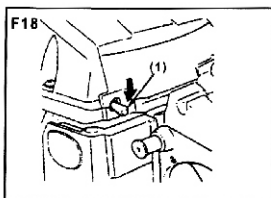

for a few minutes .  
 2.Put the switch to the "O" (STOP) position. (F18)

**(1) Switch**

**8.SAWING**

**▲WARNING**

- Before proceeding to your job, read "For Safe Operation" section . It is recommended to first practice sawing easy logs. This also helps you get accustomed to your unit.
- Always follow the safety regulations. The chain saw must only be used for cutting wood .It is forbidden to cut other types of material. Vibrations and kickback vary with different materials and the requirements of the safety regulations would not be respected. Do not use the chain saw as a lever for lifting, moving or splitting objects . Do not lock it over fixed stands. It is forbidden to hitch tools or applications to the P.t.o. that are not specified by the manufacturer.
- It is not necessary to force the saw into the cut. Apply only light pressure while running the engine at full throttle.
- When the saw chain is caught in the cut, do not attempt to pull it out by force, but use a wedge or a lever to open the way.

**■ GUARD AGAINST KICKBACK ( F19)**

- This saw is equipped with a chain brake that will stop the chain in the event of kickback if operating properly. You must check the chain brake operation before each usage by ruming the saw at full the throttle for 1-2 seconds and pushing the front hand guard forward. The chain should stop immediately with the engine at full speed. If the chain is slow to stop or does not stop, replace the brake band and clutch drum before use.

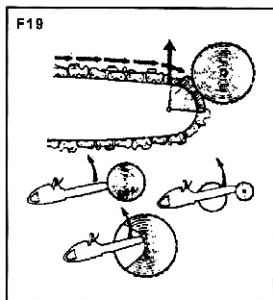

- (5) Do not overreach or cut above shoulder height.
- (6) Follow manufactures sharpening and maintenance instructions for saw chain.
- (7) Only use replacement bars and chains specified by the manufacturer or the equivalent.

**■ MAINTENANCE**

- In order to maintain your product in proper working order, perform the maintenance and checking operations described in the manual at regular intervals.
- Always be sure to turn off the engine before performing any maintenance or checking procedures.



**▲WARNING**

**The metallic parts reach high temperatures immediately after stopping the enging.**

- Leave all maintenance other than the items listed in the Owner's Manual to your competent servicing dealer.

**■ TRANSPORTATION**

- Always carry the unit with the engine stopped, the guide bar covered with the protector to the rare, and muffler away from your body.

**5. INSTALLING GUIDE BAR AND SAW CHAIN**

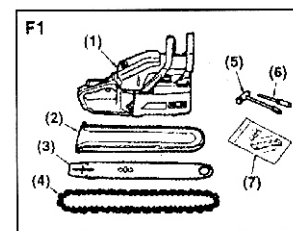

A standard saw unit package contains the items as the items as illustrated.(F1)

- (1) Power unit
- (2) Bar protector
- (3) Guide bar
- (4) Chainsaw
- (5) Plug wrench
- (6) Screwdriver for carburetor adjustment
- (7) Spike and mounting screws

Open the box and install the guide bar and the saw chain on the power unit as follows:

**▲ WARNING**

The saw chain has very sharp edges. Use thick protective gloves for safety.

1. Pull the guard towards the front handle to check that the chain brake is not on.
2. Loosen the nuts and remove the chain cover.
3. Install the attached spike to the power unit.
4. Gear the chain to the sprocket and, while fitting the saw chain around the guide bar, mount the guide bar to the power unit. Adjust the position of chain tensioner nut on the chain cover to the lower hole of guide bar.(F2)

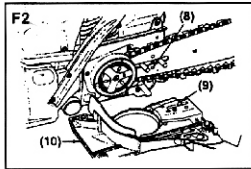

- (8) Hole
- (9) Tensioner nut
- (10) Chain cover

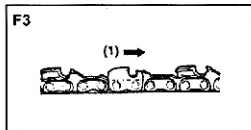

**NOTE**

Pay attention to the correct direction of the saw chain.(F3)

**(1) Moving Direction**

5. Fit the chain cover to the power unit and fasten the nuts to finger tightness.
6. While holding up the tip of the bar, adjust the chain tension by turning the tensioner screw until the tie straps just touch the bottom side of the bar rail.(F4)
7. Tighten the nuts securely with the bar tip held up (12~15N.m). Then check the chain for smooth rotation and proper tension while moving it by hand. If necessary, readjust with the chain cover loose.
8. Tighten the tensioner screw.

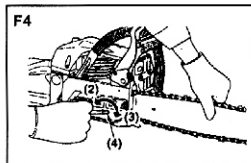

- (2) Loosen
- (3) Tighten
- (4) Tensioner screw

**▲ WARNING**

Continuing to use the product in anti-freeze mode even when temperatures have risen and returned to normal may result in the engine failing to start properly or in the engine failing to operate at its normal speed, and for this reason you should always be sure to return the unit to normal operating mode if there is no danger of icing occurring.

When using the saw with the anti-freeze mode, frequently check the screen and keep it clean of saw dust.

**■ CHAIN BRAKE**

This machine is equipped with an automatic brake to stop saw chain rotation upon occurrence of kickback while in saw cutting operation. The brake is automatically operated by inertial force which acts on the weight fitted inside the front guard. This brake can also be operated manually with the front guard turned down to the guide bar. (F16)

To release brake, pull up the front guard toward the front handle till "click" sound is heard.

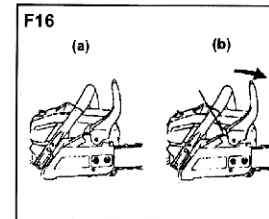

**[Caution]**

Be sure to confirm brake operation on the daily inspection

How to confirm

- (1) Turn off the engine.
  - (2) Holding the chain saw horizontally, release your hand from the front handle, hit the tip of the guide bar to a stump or a piece of wood, and confirm brake operation. Operating level varies by bar size. (F17)
- In case the brake is not effective, ask our dealer inspection and repairing. The engine, if being kept rotated at high speed with the brake engaged, heats the clutch, causing a trouble. When the brake is operated while in operation, immediately release your fingers from the throttle lever and keep the engine idling.

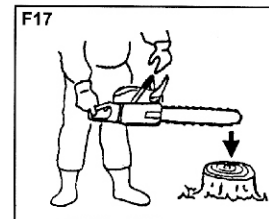

**■ STOPPING ENGINE**

1. Release the throttle lever to allow the engine idling

5. Make a test cut and adjust the H needle for best cutting power, not for maximum speed.

- (1) L needle
- (2) H needle
- (3) Idle adjusting screw

#### ■ CARBURETOR ANTI-FREEZE MECHANISM

Operating the chain saw in temperatures of 0-5°C at times of high humidity may result in ice forming within the carburetor, and this in turn may cause the output power of the engine to be reduced or for the engine to fail to operate smoothly. This product has accordingly been designed with a ventilation hatch the back of the air cleaner cover to allow warm air to be supplied to the engine and to thereby prevent icing from occurring.

Under normal circumstances the product should be used in normal operating mode, i.e., in the mode to which it is set at the time of shipment. However when the possibility exists that icing may occur, the unit should be set to operate in anti-freeze mode before use. (F15)

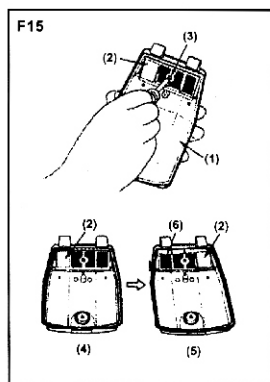

#### ■ HOW TO SWITCH BETWEEN OPERATING MODES (F15)

1. Flip the engine switch to turn off the engine.
2. Remove the air cleaner cover from the cylinder cover
3. Loosen a screw and remove the screen on the back of the air cleaner cover.
4. Reattach the screen right side left so as to the anti-icing plate is on the right. Reinstall the cover.

- (1) Air cleaner cover
- (2) Anti-icing plate
- (3) Screw
- (4) Normal operating mode
- (5) Anti-freeze mode
- (6) Screen

#### NOTE

A new chain will expand its length is the beginning of use. Check and readjust the tension frequently as a loose chain can easily derail or cause rapid wear of itself and the guide bar.

## 6. FUEL AND CHAIN OIL

### ■ FUEL

Mix a regular gasoline (leaded or unleaded, alcohol-free) and a quality-proven motor oil for air cooled 2 cycle engines.

#### Recommended mixing ratio:

Condition	Gasoline : Oil
Up to 20 hours use	20:1
After 20 hours use	25:1

#### 25:1 Mix Chart

Gasoline liters	1	2	3	4	5
2-cycle oil ml.	40	80	120	160	200

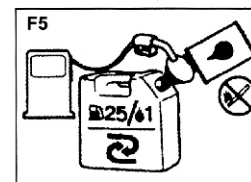

#### ▲ WARNING

- Keep open flames away from the area where fuel is handled or stored.
- Mix and store fuel only in an approved gasoline container.

#### NOTE

Most engine troubles are caused, directly or indirectly, by the fuel used on the machine. Take special care not to mix a motor oil for 4 cycle engines.

### ■ CHAIN OIL

Use motor oil SAE# 10W ~ 30 all year round or SAE #30 ~ #40 in summer and SAE#20 in winter.

#### NOTE

Do not use wasted or regenerated oil that can cause damage to the oil pump.

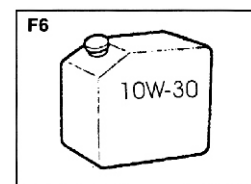

## 7. OPERATING ENGINE

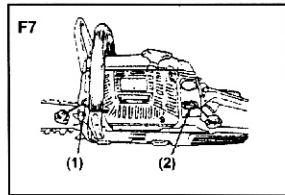

### ■ STARTING ENGINE

1. Fill fuel and chain oil tanks respectively, and tighten the caps securely.(F7)
2. Put the switch to "I" position.(F8)
3. While holding the throttle lever together with the throttle interlock, push in the side throttle lock button and release the throttle lever to hold it at the starting position.(F9)

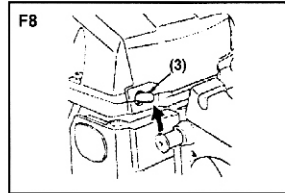

- (1) Chain oil
- (2) Fuel
- (3) Switch
- (4) Throttle lock button
- (5) Throttle lever
- (6) Throttle interlock
- (7) Choke knob

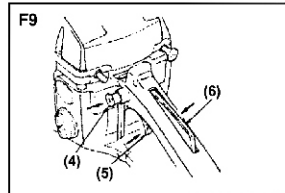

4. Pull out the choke knob to the closed position.(F10)

#### NOTE

When restarting immediately after stopping the engine, leave the choke knob at the open position.

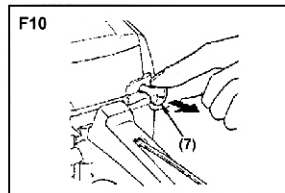

5. While holding the saw unit securely on the ground, pull the starter rope vigorously. (F11)

#### ▲ WARNING

**DO not start the engine while hanging the chain saw with a hand .The saw chain may touch your body. It's very dangerous.**

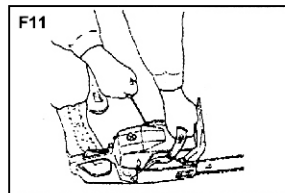

6. When engine has ignited first ,push in the choke knob and pull the starter again to start the engine
7. Allow the engine to warm up with the throttle lever pulled slightly.

#### ▲ WARNING

Keep clear of the saw chain as it will start rotating upon starting of engine.

### ■ CHECKING OIL SUPPLY

After starting the engine, run the chain at medium speed and see if chain oil is scattered off as shown

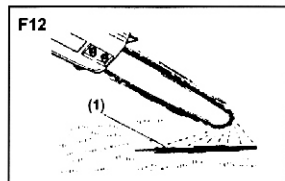

in the figure. (F12)

(1)Chain oil

The chain oil flow can be changed by inserting a screwdriver in the hole on bottom of the clutch side. Adjust according to your work conditions.

(F13)

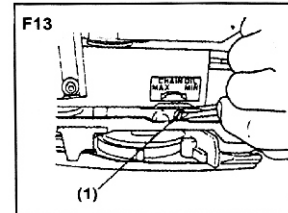

(1) Adjuster

#### NOTE

The oil tank should become nearly empty by the time fuel is used up. Be sure to refill the oil tank every time when refueling the unit.

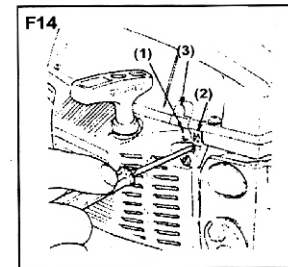

### ■ ADJUSTING CARBURETOR(F14)

The carburetor on your unit has been factory adjusted, but may require fine tuning due to change in operating conditions. Before adjusting the carburetor, make sure that provided are clean air/fuel filters and fresh, properly mixed fuel. When adjusting, take the following steps:

#### NOTE

Be sure to adjust the carburetor with the bar chain attached

1. Stop engine and screw in both H and L needles until they stop. Never force. Then set them back the initial number of turns as shown below.

**H needle:**  $1\frac{3}{8}$

**L needle:**  $1\frac{1}{4}$

2. Start engine and allow it to warm up at half-throttle.
3. Turn L needle slowly clockwise to find a position where idling speed is maximum, then set the needle back a quarter (1/4) turn counterclockwise.
4. Turn idle adjusting screw (T) counterclockwise to that saw chain does not turn. If idling speed is too slow, turn the screw clockwise.