

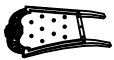







# Assembly Instruction

## SIDE CHAIR

### PART LIST

1		CHAIR BACK	1 PC
2		CHAIR SEAT	1 PC
3		LEG	2 PCS

### HARDWARE LIST

A		LONG BOLT 5/16"x3-1/4"	4 PCS
B		MEDIUM BOLT 5/16"x2-1/2"	4 PCS
C		SHORT BOLT 5/16"x1-3/4"	1 PC
D		SPRING WASHER 5/16"	9 PCS
E		FLAT WASHER 5/16"x22mm	9 PCS
F		ALLEN KEY 5/16"	1 PC

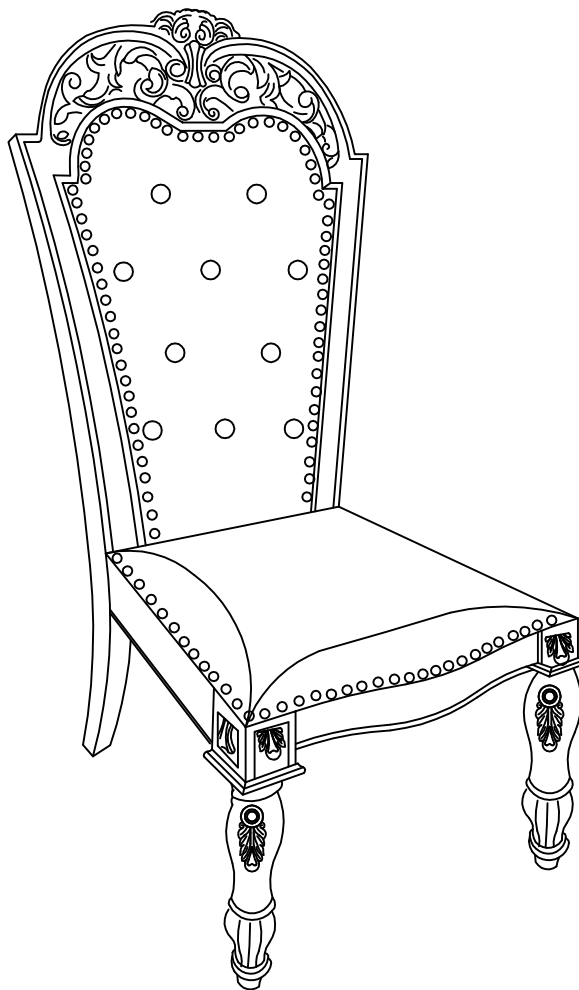

## STEP 1

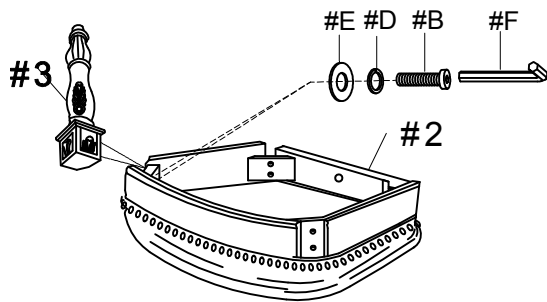

## STEP 2

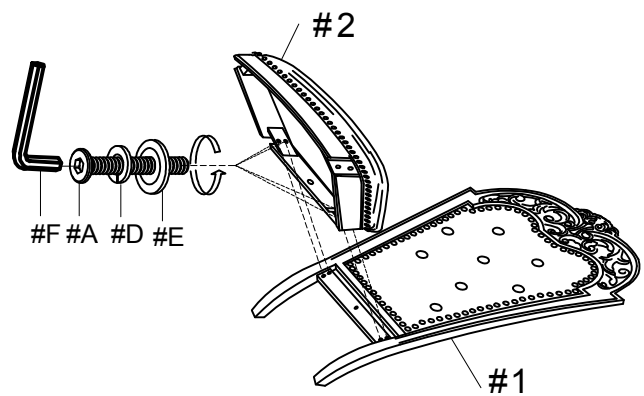

## STEP 3

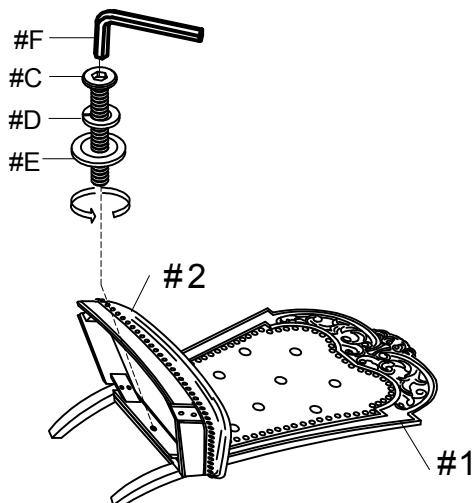

## STEP 4

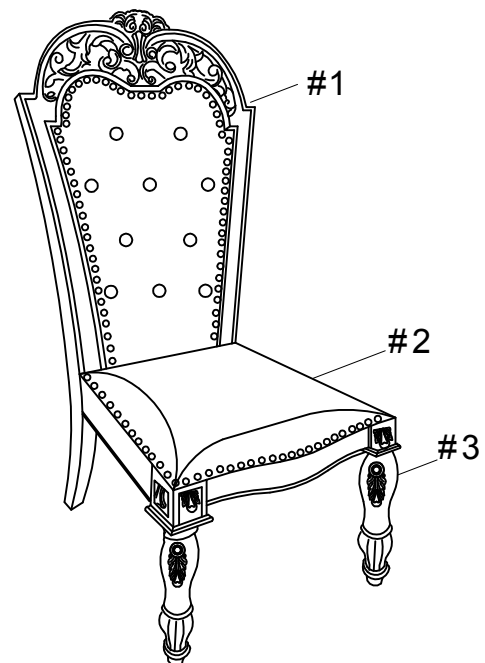

- For items use on wooden floor hard surfaces or carpets. It is recommended to install protective pads under all legs and supports to avoid/prevent from damages/scratches and discoloration.
- Hardware may loosen over time. Periodically check to make sure all connections are tight. Re-tight if necessary.