

# ASSEMBLY INSTRUCTIONS

---

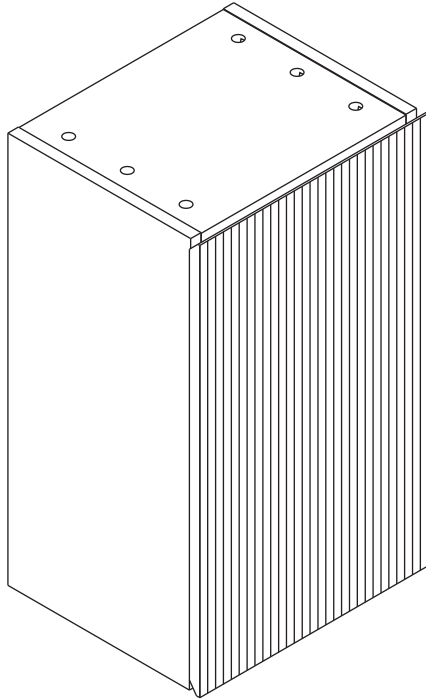



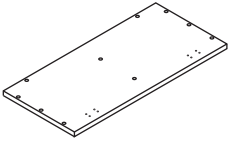
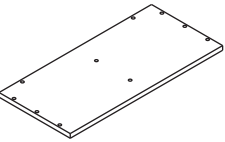
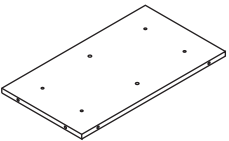
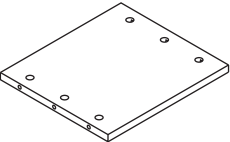
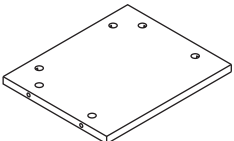
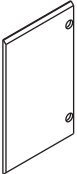

Bathroom Vanity

# ASSEMBLY INSTRUCTIONS

1		x1			
2		x1			
3		x1			
4		x2			
5		x1			
6		x1			

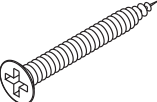
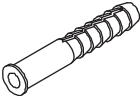
# ASSEMBLY INSTRUCTIONS

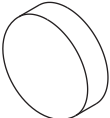
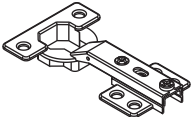
<p><b>A</b></p>	 <p>Ø6x26mm</p>	<p>x26</p>			
<p><b>B</b></p>	 <p>Ø15x9mm</p>	<p>x26</p>			
<p><b>C</b></p>	 <p>Ø3.5x14mm</p>	<p>x12</p>			
<p><b>D</b></p>	 <p>Ø3.5x50mm</p>	<p>x4</p>			
<p><b>E</b></p>		<p>x4</p>			
<p><b>F</b></p>		<p>x4</p>			
<p><b>G</b></p>		<p>x4</p>			
<p><b>H</b></p>		<p>x2</p>			

# ASSEMBLY INSTRUCTIONS

## Use the Cam Lock and Eccentric Wheel

### ECCENTRIC WHEEL

Tighten the bolt until the shoulder is aligned with the panel.  
Be sure not to tighten too much or too little.

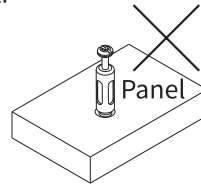
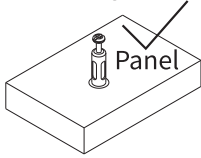

The pre-inserted nut should align with the center of the cam lock when joining two panels. The cam lock should be inserted before the eccentric wheel.

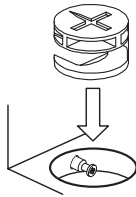

Turn the cam lock clockwise to tighten.

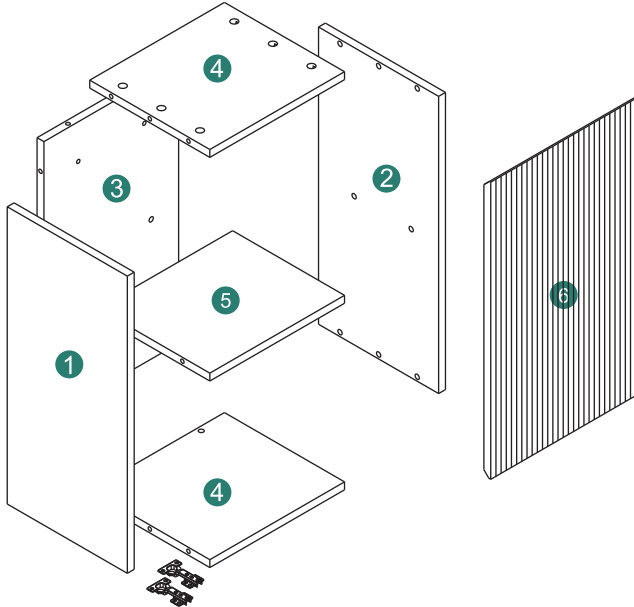

# ASSEMBLY INSTRUCTIONS

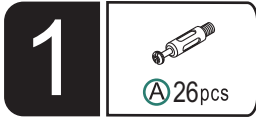

The floor needs to be covered with paper or carpet protective material before installation!

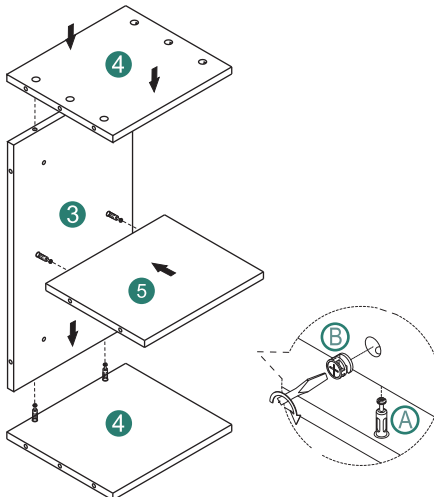
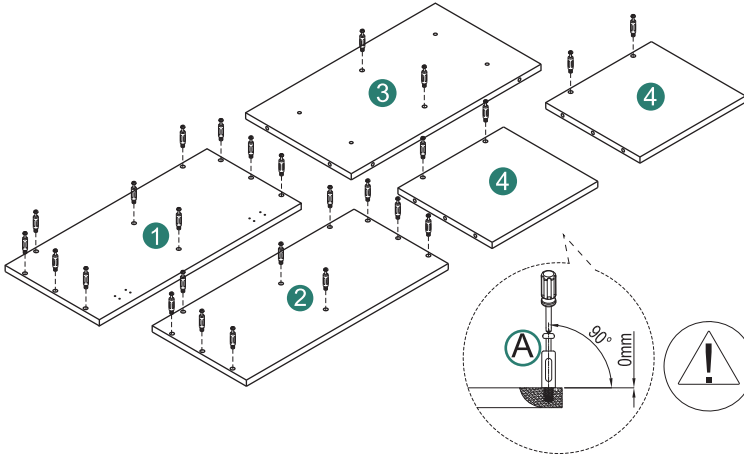

# ASSEMBLY INSTRUCTIONS

3

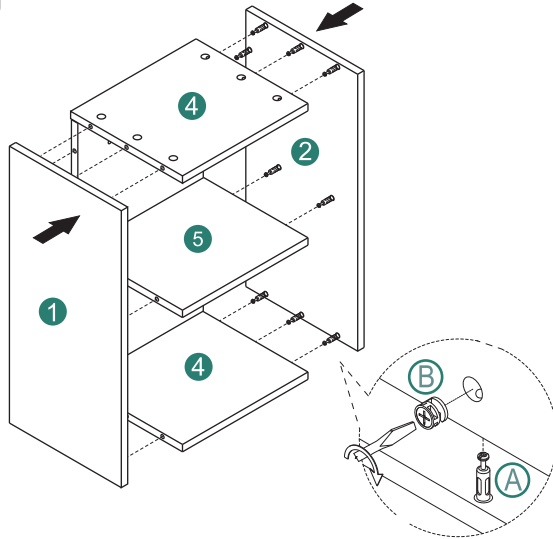

4

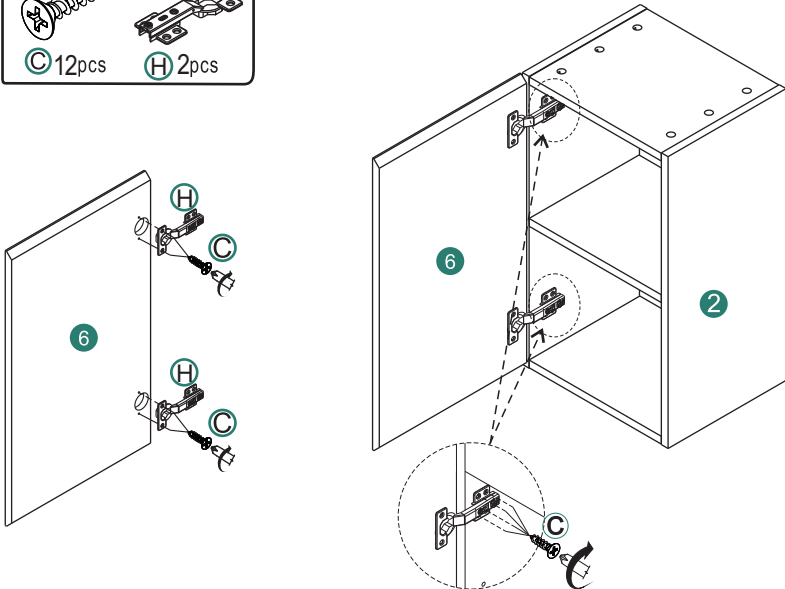

6

# ASSEMBLY INSTRUCTIONS

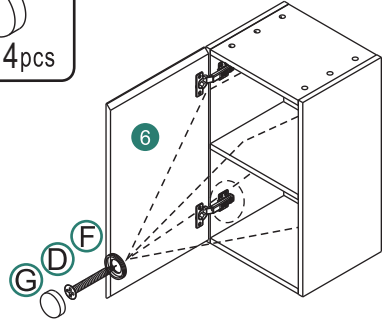
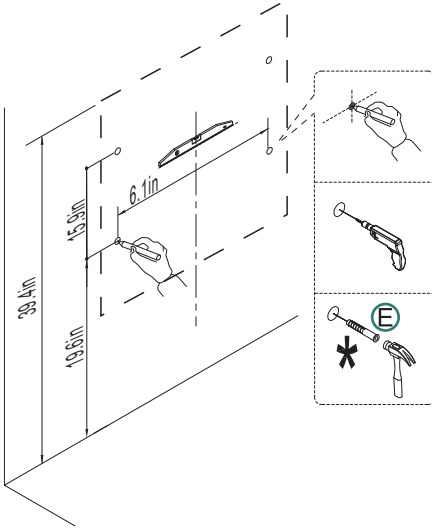
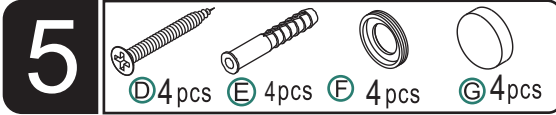

## HINGE ADJUSTMENT AND REMOVAL INSTRUCTION

DOOR INSTALL

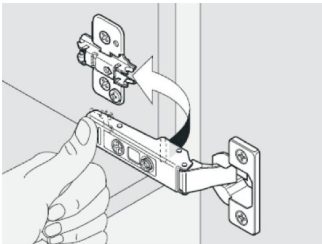

DOOR REMOVE

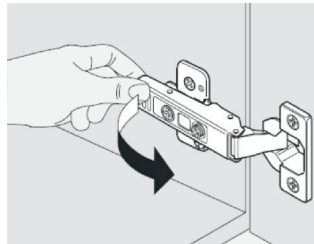

### HOW TO ADJUST HINGES (if required)

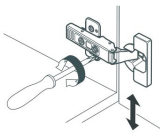

adjust height

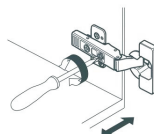

adjust laterally

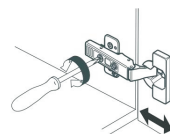

adjust depth

### DRAWERS REMOVAL & RE-INSTALLATION (if required)

REMOVAL

7

RE-INSTALLATION

### PIVOT-PRO side adjustment

Side adjustment of the door is made by using the indicated screw.

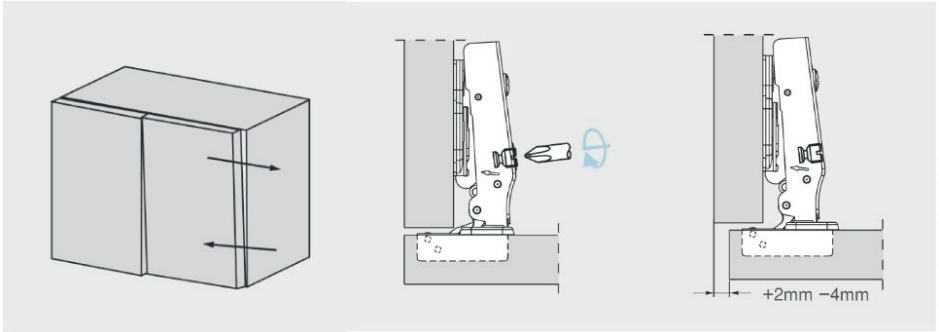

### PIVOT-PRO Depth Adjustment

Depth adjustment is made without loosening any screw. The door can be moved in or out by rotating the cam adjuster on the hinge arm.

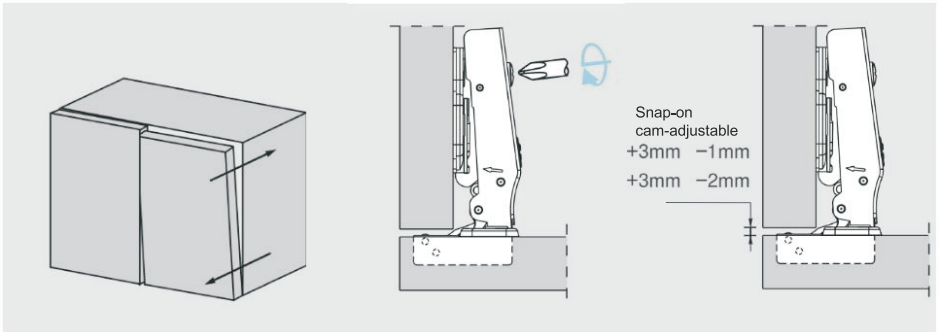

### PIVOT-PRO Height Adjustment

By loosening the two fixing screws to allow the mounting plate to slide up or down, the door can be adjusted vertically by  $\pm 2\text{mm}$ . After retightening the screws, the Depth adjustment is done.

