

Patio Chaise Lounge Chair Assembly Manual

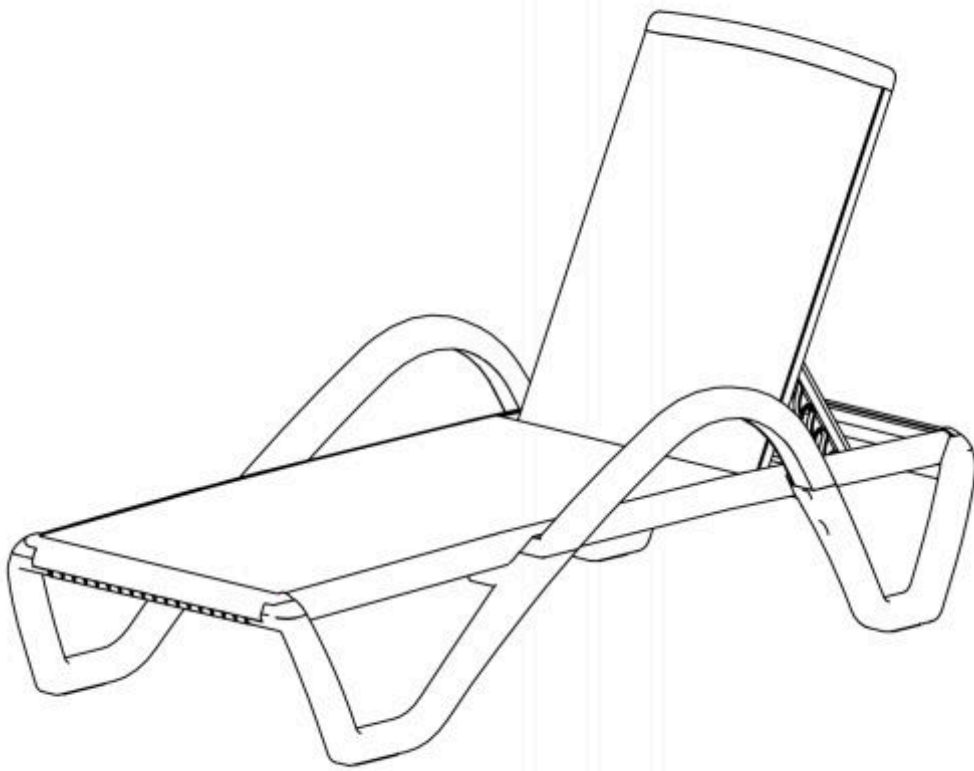

- Prior to assembly, please confirm all of the parts listed included.
- All bolts should be tightened before use. Maybe, you need allen wrench for assembly.

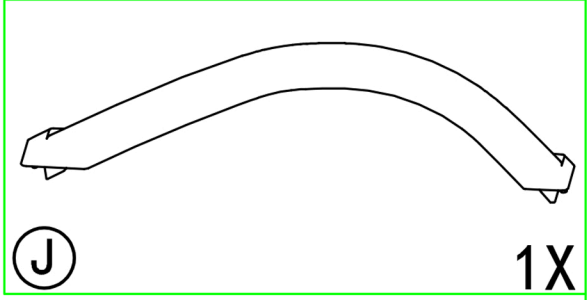
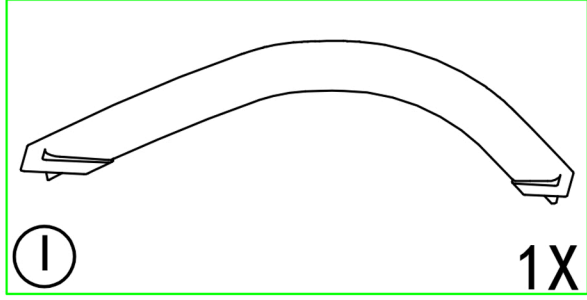
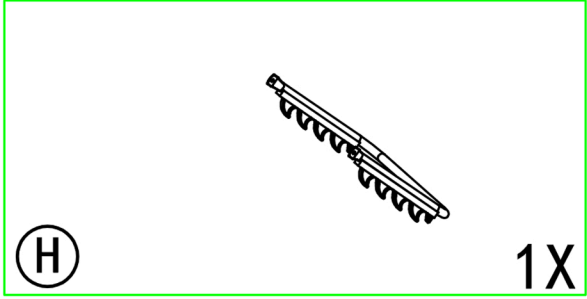
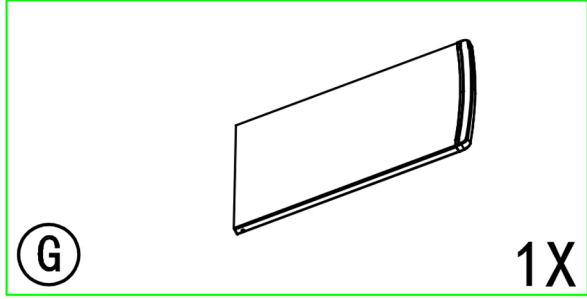
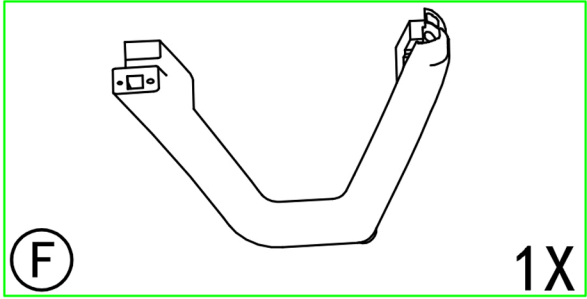
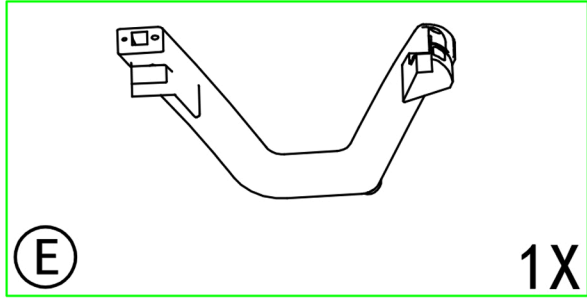
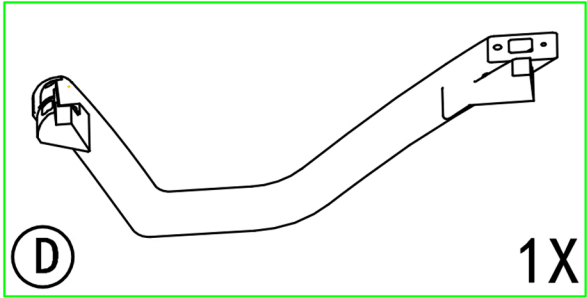
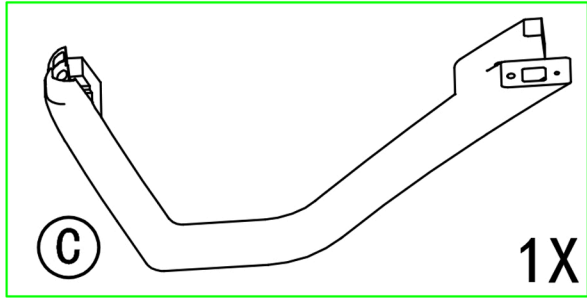
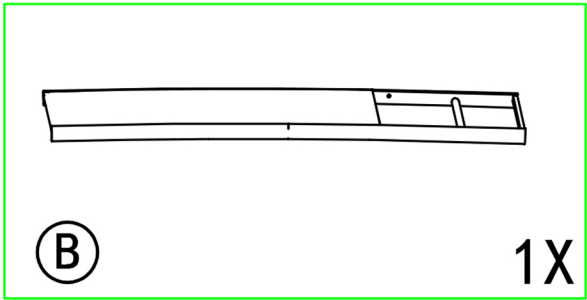
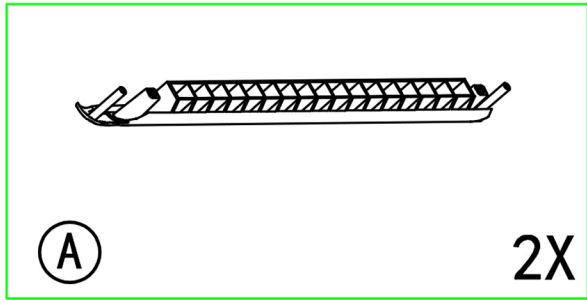

Please assemble the lounge chair on the carton or carpet to avoid scratch.

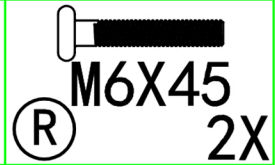
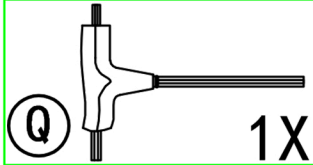
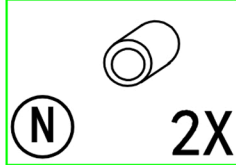
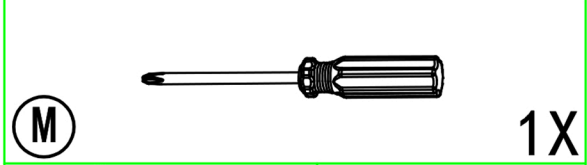
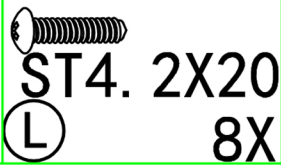
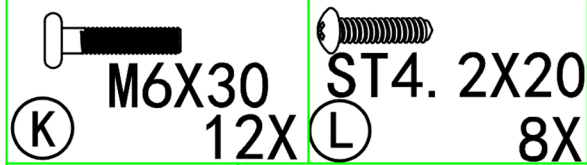
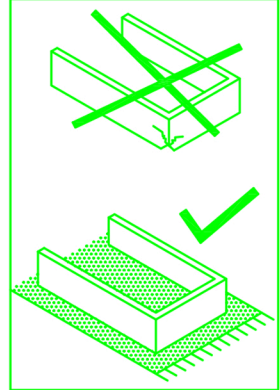

Assemble four legs Part C,Part D,Part F and Part E to the seat Part B with screws Part K.

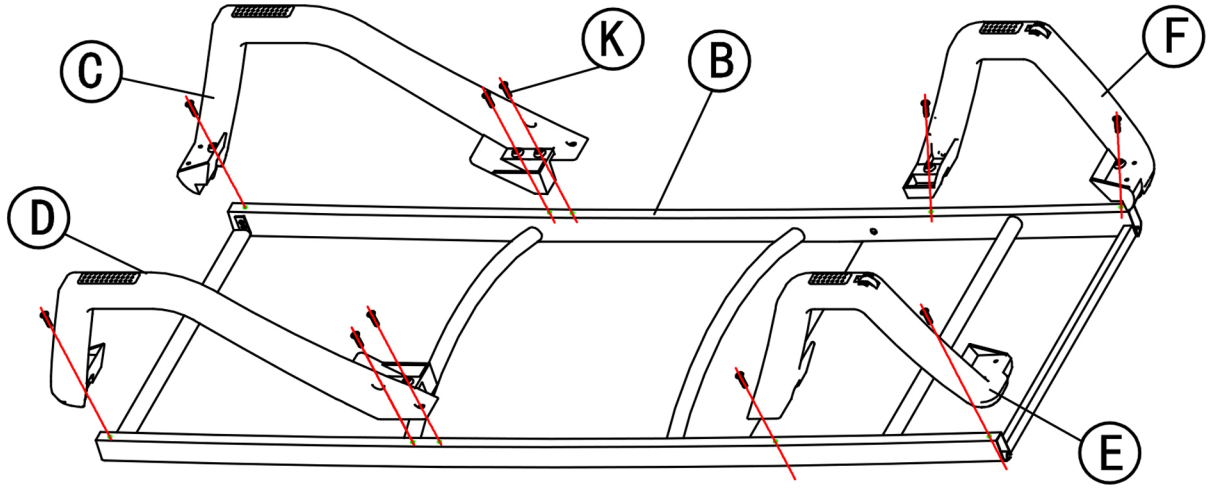

Assemble Part A to the seat Part B,then assemble Armrest Part I and Part J to the seat Part B.

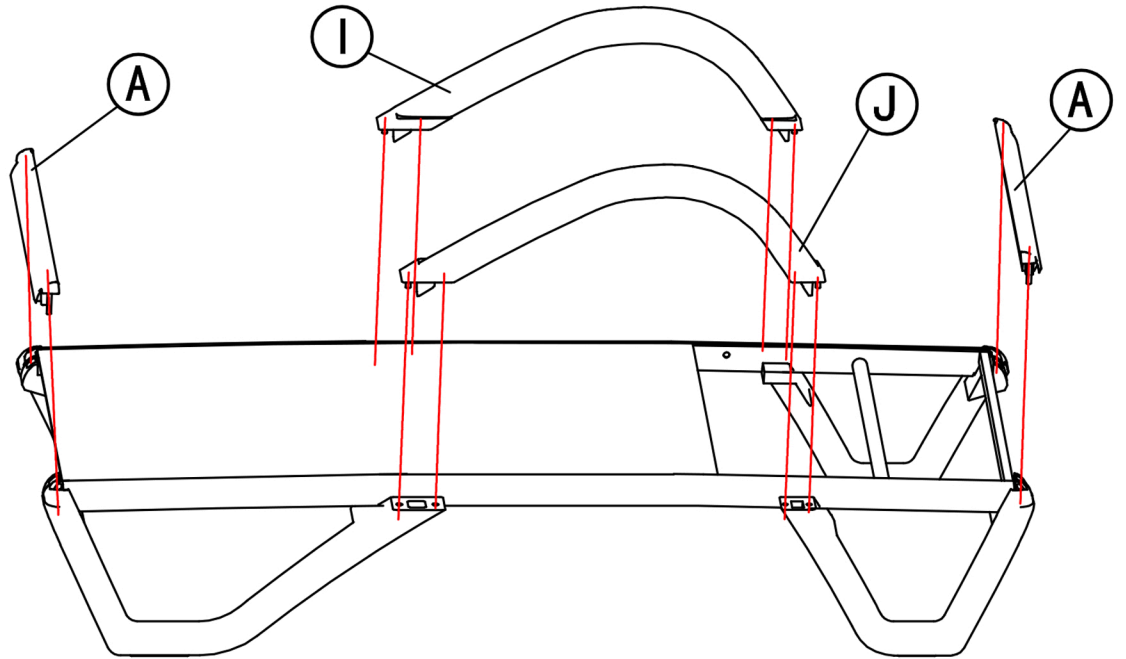

Then use screws Part L and Part P to lock the legs. Tighten all screws before using.

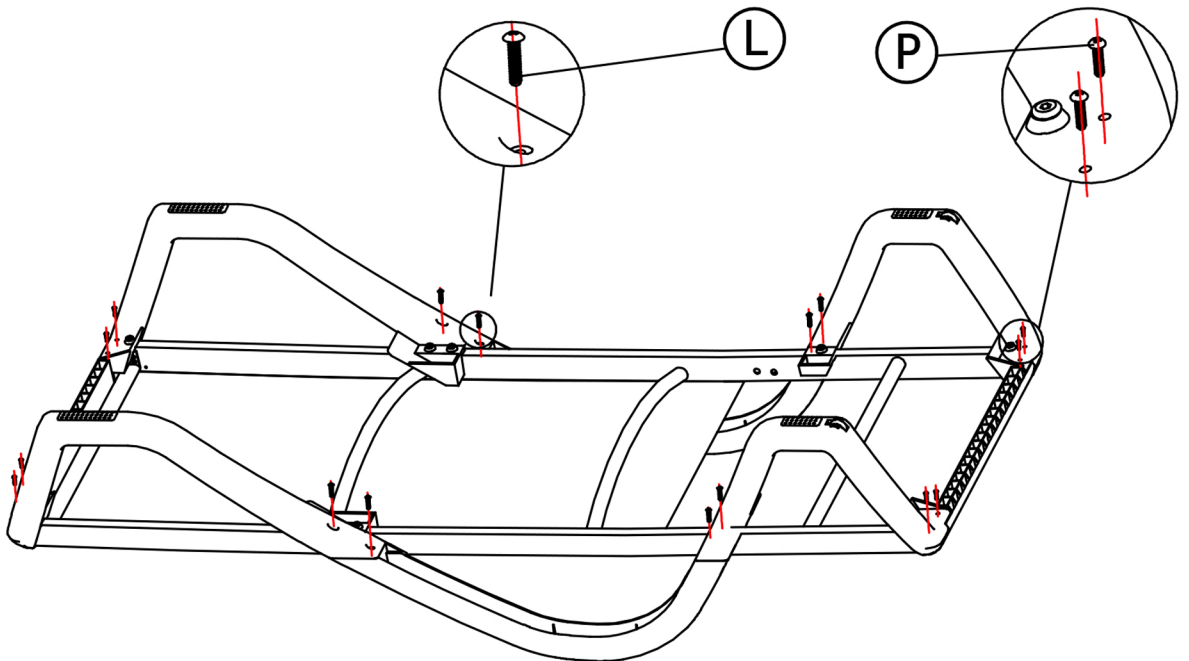

Assemble backrest Part G and adjustable gear Part H together using screws Part K and Part N.

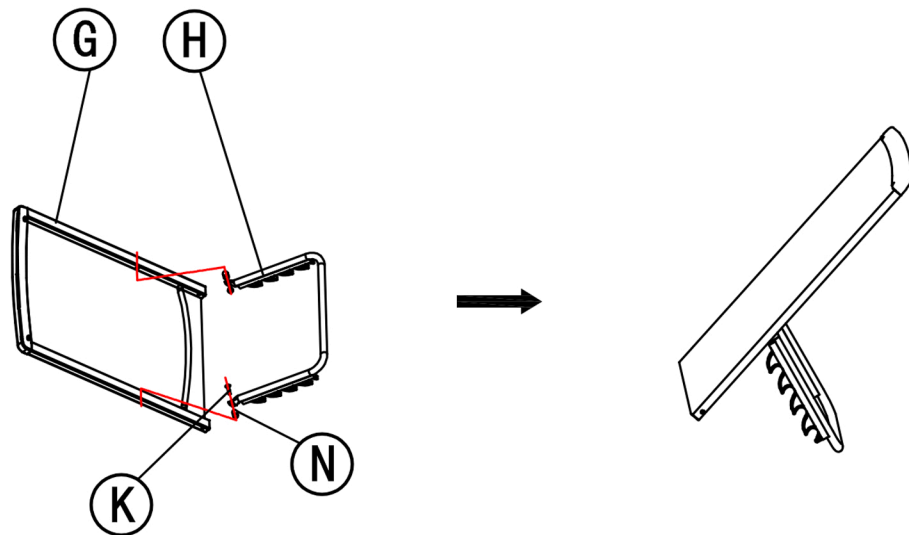

Assemble backrest and adjustable gear to the seat Part B with screws Part R.

