

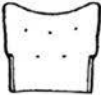

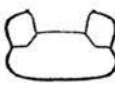





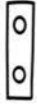

# ASSEMBLY INSTRUCTIONS

<p>A</p> 	<p>B</p> 	<p>C</p>  <p>x2 chair front feet</p>	<p>D</p>  <p>x2</p>	<p>E</p>  <p>x24</p>	<p>F</p>  <p>x4</p>	<p>G</p>  <p>x4</p>	<p>H</p>  <p>X1</p>	<p>I</p>  <p>x2 back leg with adjustable screw</p>	<p>J</p> 	<p>K</p>  <p>x4 Ottoman feet</p>
---	--	---	--	---	--	--	--	---	--	---

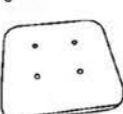

5. Turn the bottom of the product up.

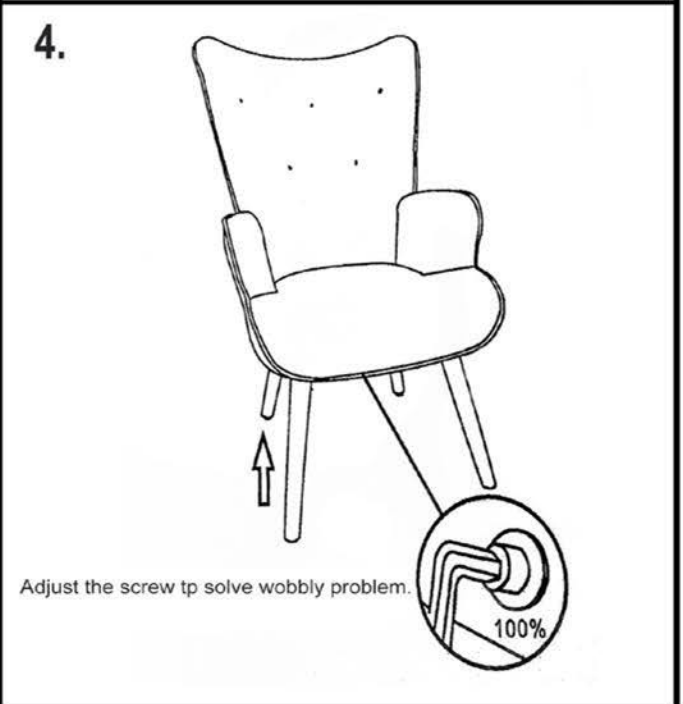
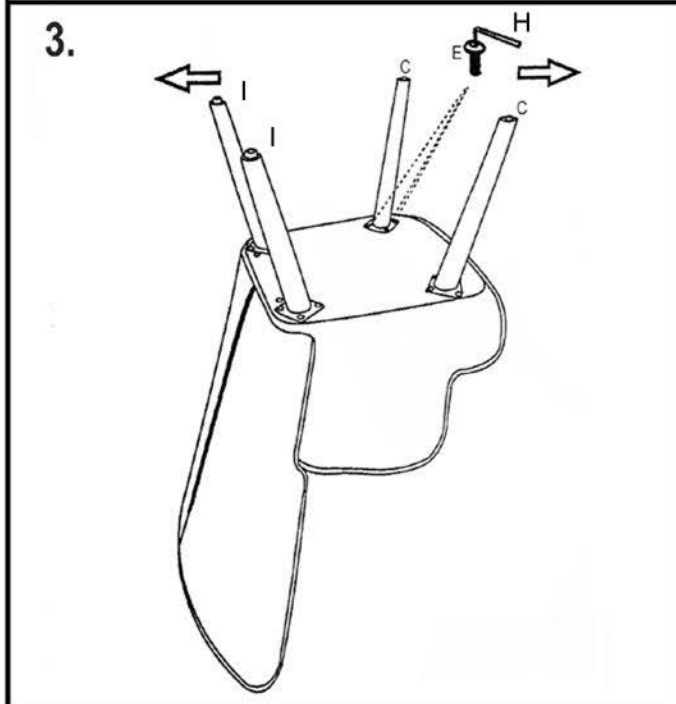
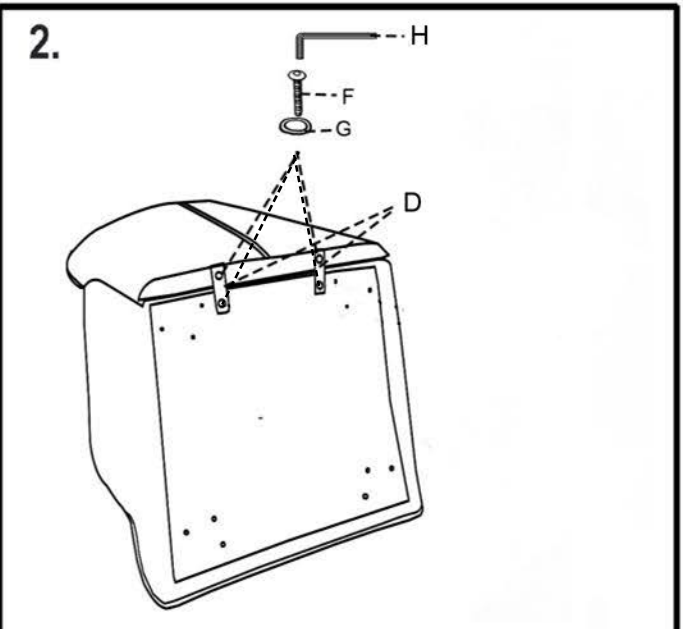
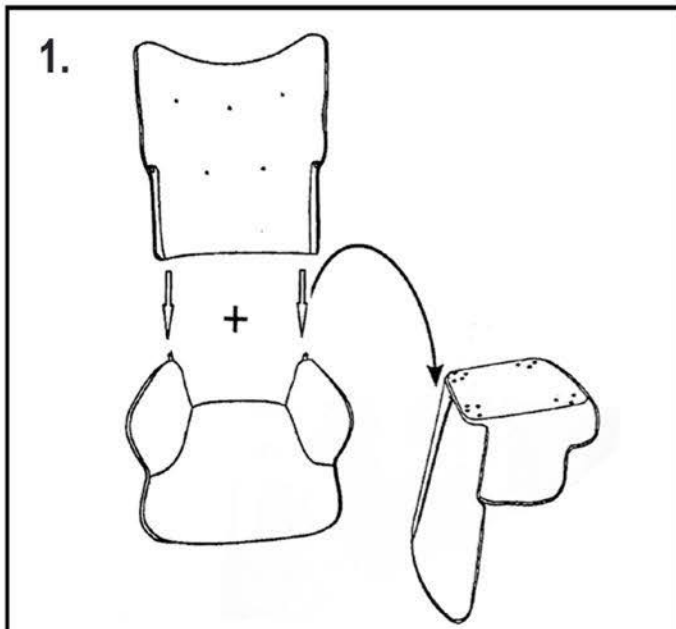
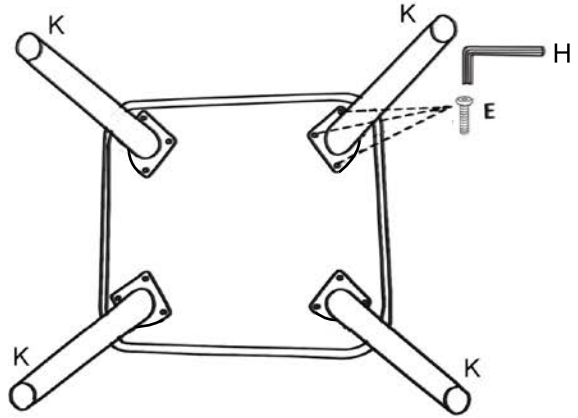
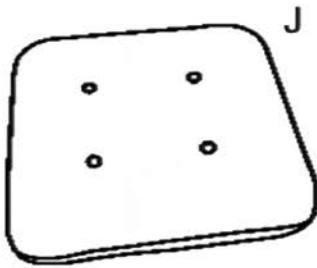

6. Finish.

