

ASSEMBLY INSTRUCTION

Step 1:

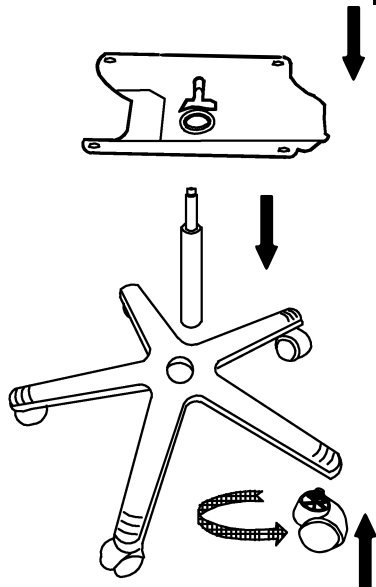

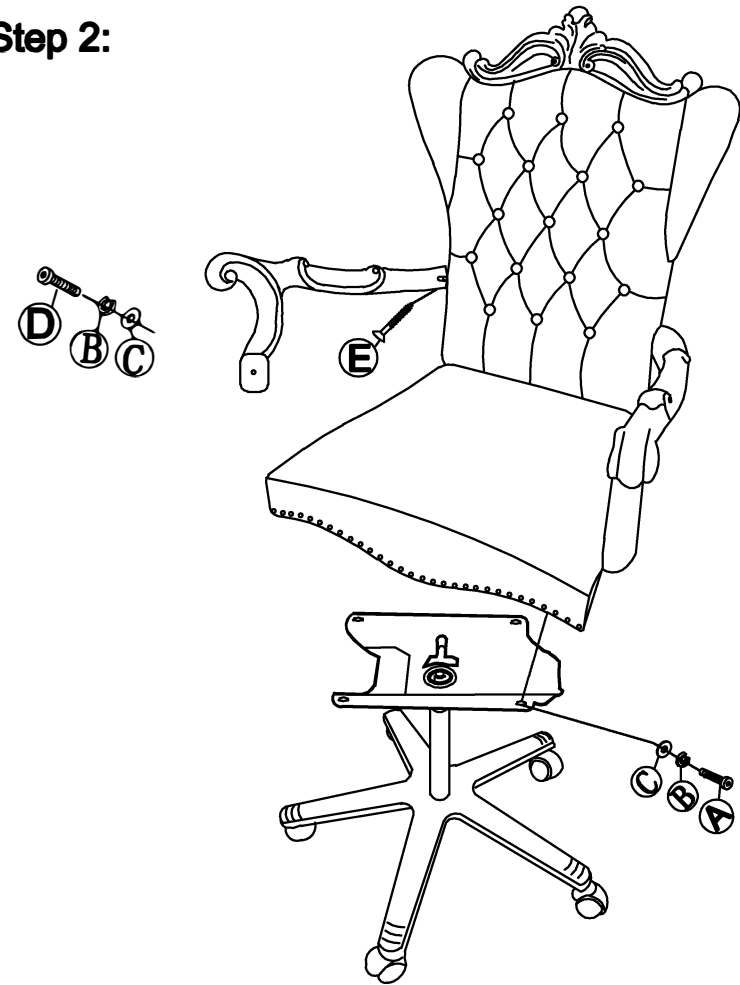



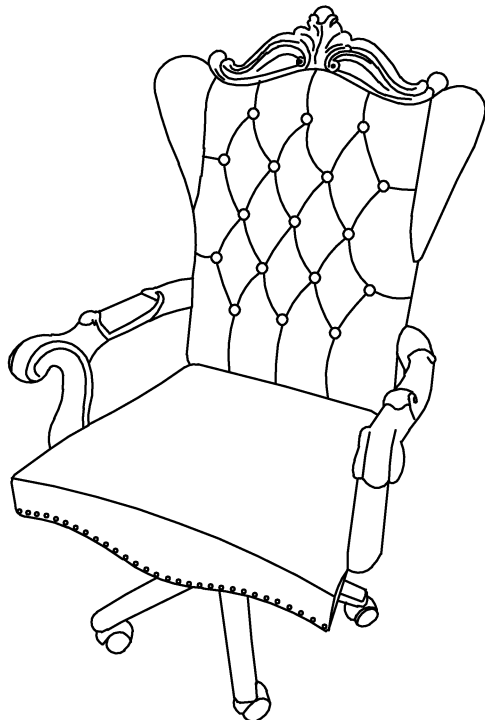

Step 2:



Finish :



Hardware List:

No.:	Description	Drawing	Size	Q' ty
A	Middle Bolt		φ5/16" X1-1/4 "	4
B	Lock Washer		φ5/16" X12mm	6
C	Flat Washer		φ5/16" X22mm	6
D	Long Bolt		φ5/16" X1-3/4 "	2
E	Wood Screw		φ8 X 1-1/4"	2
F	Allen Wrench		5mm	1