

DIMENSIONS

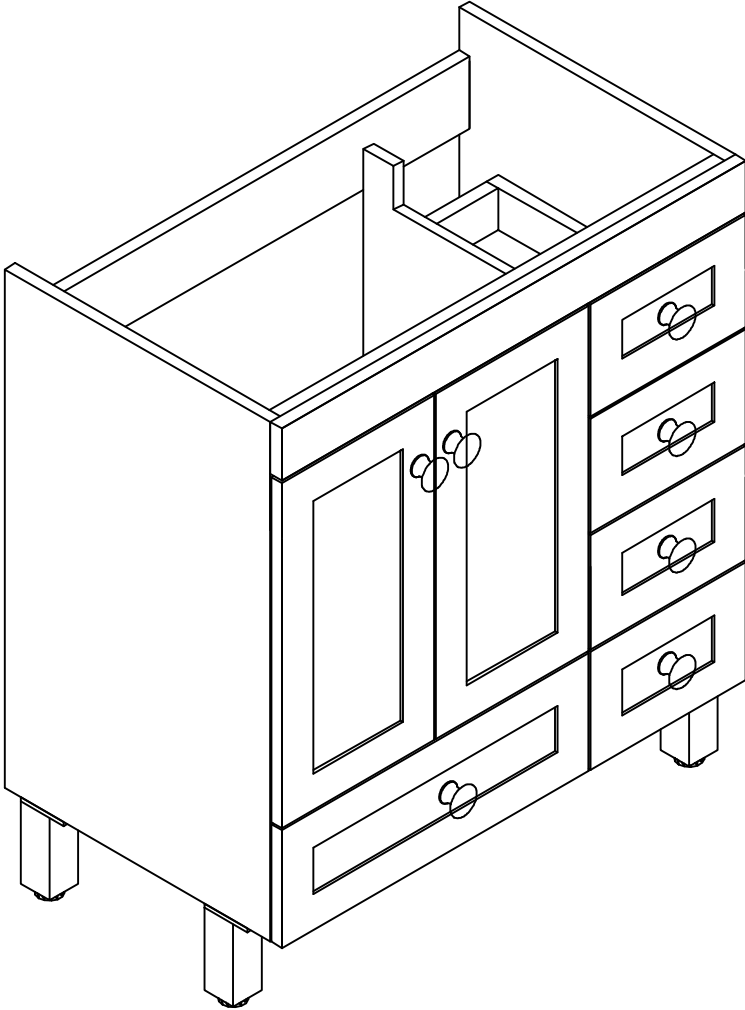

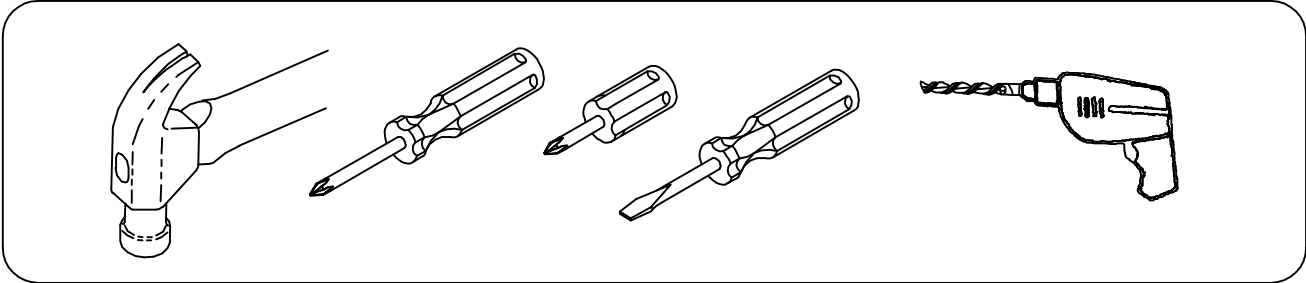





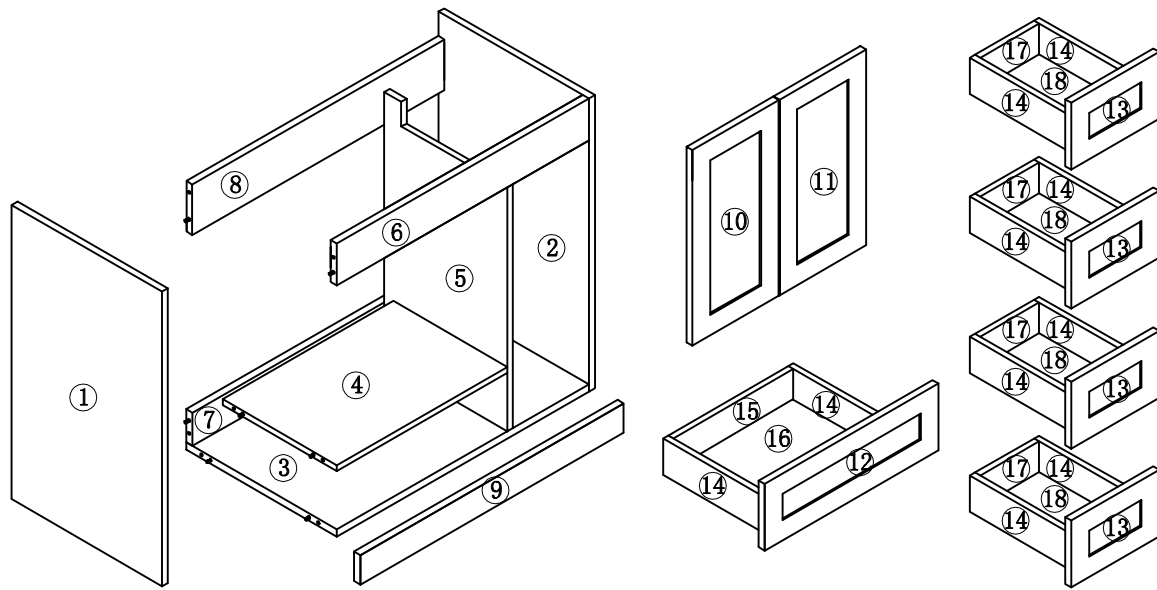













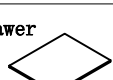







YOU MAY NEED (NOT SUPPLY)



ASSEMBLY DIAGRAM

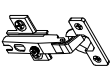

PARTS LIST					
PARTS LIST					
NO	DESCRIPTION	QTY	NO	DESCRIPTION	QTY
①	Left side panel 	1	⑩	Left door panel 	1
②	Right side panel 	1	⑪	Right door panel 	1
③	Bottom panel 	1	⑫	Left Drawer front panel 	1
④	Inner shelf panel 	1	⑬	Right Drawer front panel 	4
⑤	Center partition Panel 	1	⑭	Drawer side panel 	10
⑥	Upper front panel 	1	⑮	Left Drawer rear panel 	1
⑦	Lower back panel 	1	⑯	Left Drawer bottom panel 	1
⑧	Upper back panel 	1	⑰	Right Drawer rear pane 	4
⑨	Front baffle panel 	1	⑱	Right Drawer bottom panel 	4

PARTS LIST					
HARDWARE LIST					
NO	DESCRIPTION	QTY	NO	DESCRIPTION	QTY
A	Three-in-one eccentric wheel 	59	G	4*23mm screw 	2
B	Three-in-one connecting rod 	59	H	4*18mm screw 	5
C	Three-in-one sticker 	59	I	Door handle 	2
D	8*40mm wood dowel pins 	17	J	Drawer handle 	5
E	Drawer slides 	10	K	Aluminum alloy leg 	4
F	4*16mm screw 	96	L	Door hinge 	4
CAUTION: Please confirm the parts list before installation					

STEP 1

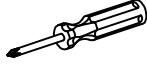
HARDWARE LIST	
Three-in-one connecting rod B  59PCS	

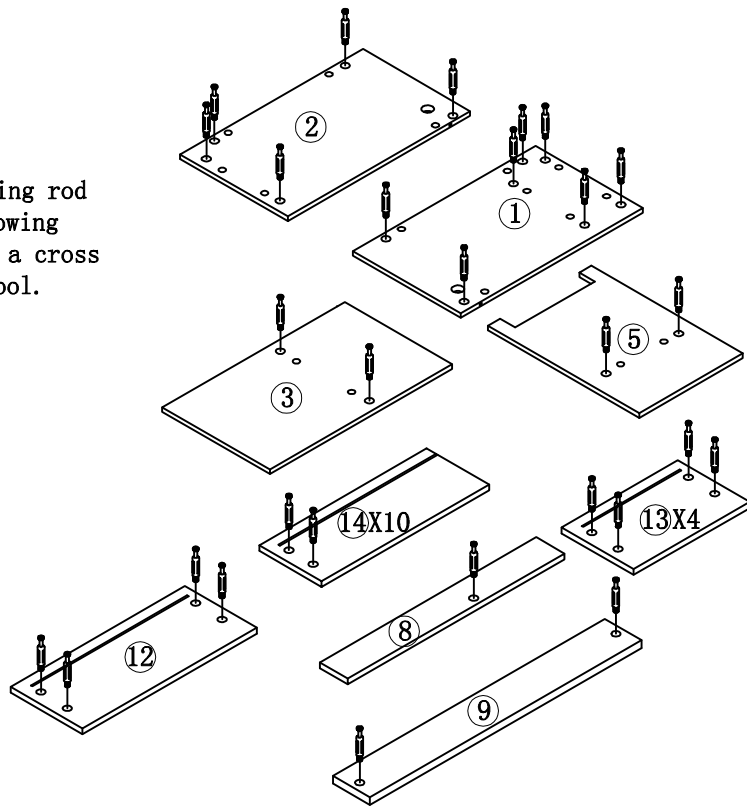
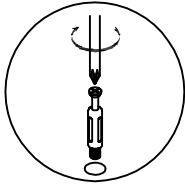

1. Put the three-in-one connecting rod in the 10mm hole of the following panels and tighten them with a cross screwdriver or an electric tool.

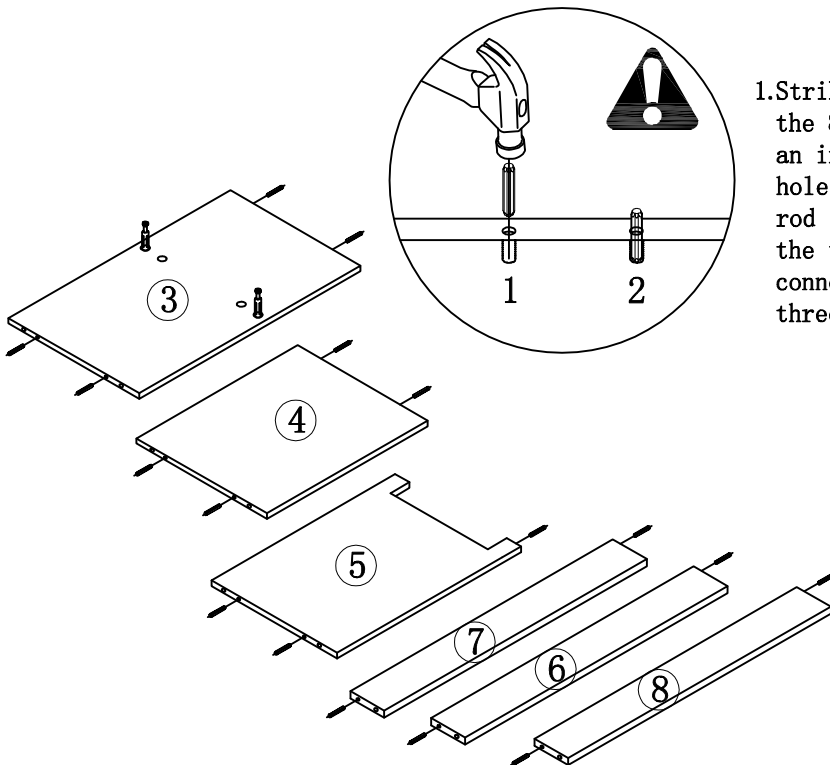

STEP 2





1. Strike the 08*40mm wood dowel pin into the 8m hole of the above panels with an iron hammer. Please note that the hole of the three-in-one connecting rod should also be 8mm. The hole of the three-in-one connecting rod connects to the hole of 15mm three-in-one eccentric wheel.

HARDWARE LIST	
8*40mm wood dowel pins D  17PCS	

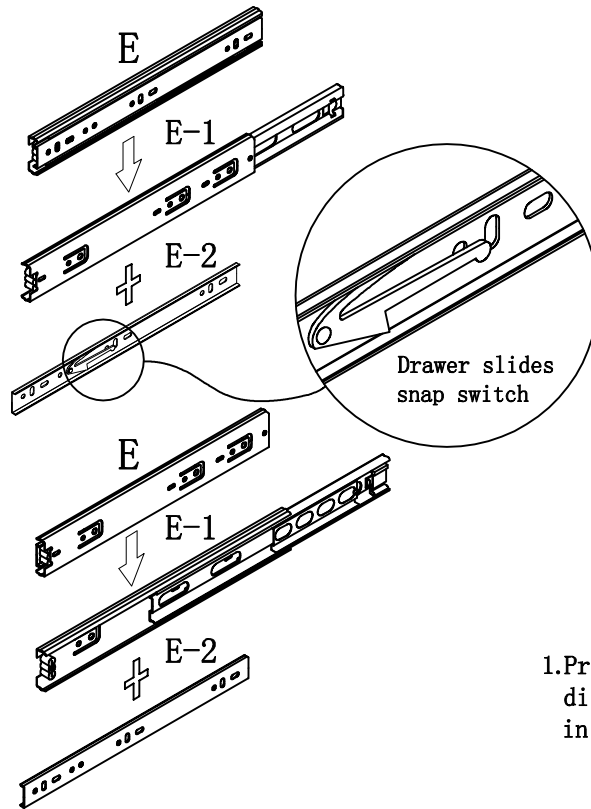
STEP 3





HARDWARE LIST	
Drawer slides	
E  10PCS	

1. Press the slide snap switch, disassemble slide blocks and put them in a place properly for further use.

STEP 4

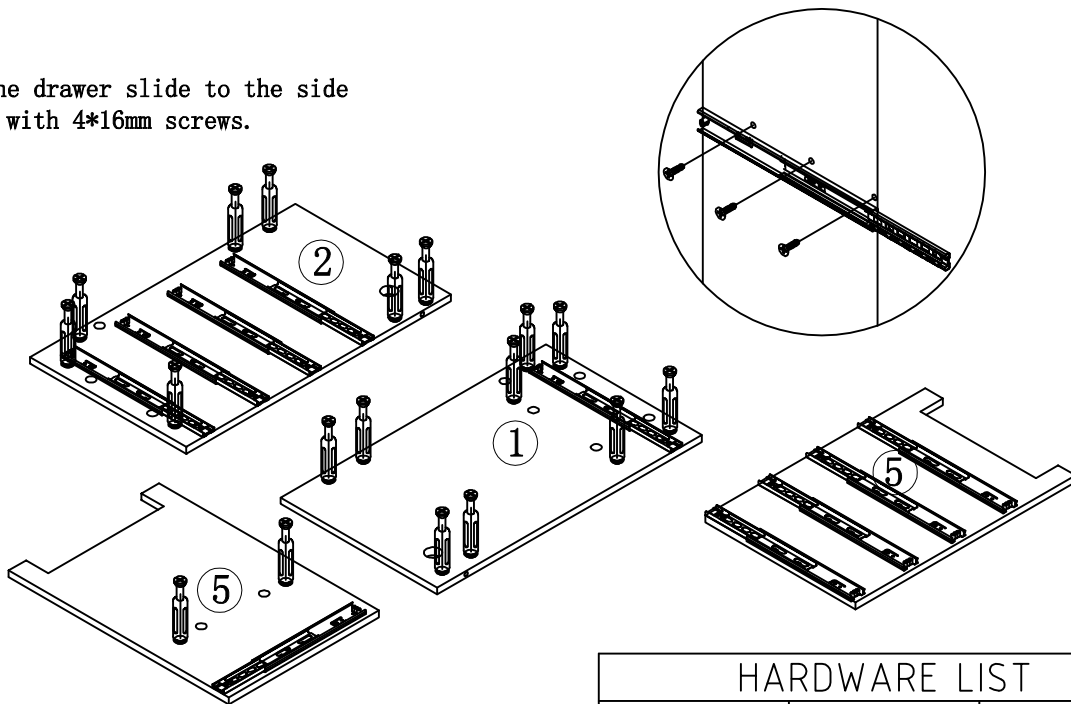
1. Fix the drawer slide to the side panel with 4*16mm screws.

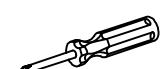

HARDWARE LIST		
4*16mm screw	Drawer slides	
F  30PCS	E-1  10PCS	

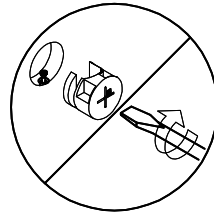
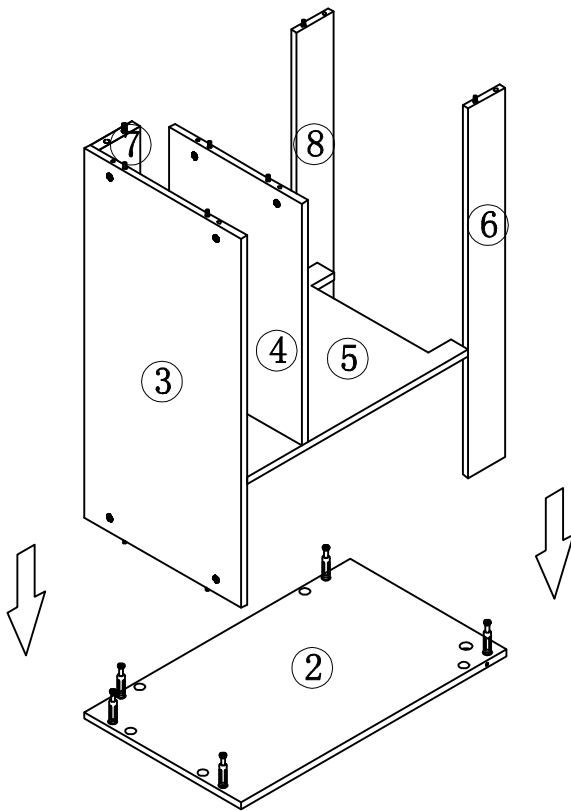

STEP 5

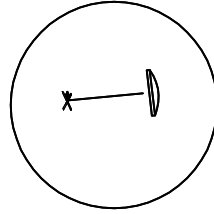

1. Connect No. 3-6-7-8 panel to No. 2 panel tightly with the three-in-one eccentric wheel.



2. Cover the mounting hole of the eccentric wheel with a three-in-one sticker.

HARDWARE LIST		
Three-in-one eccentric wheel A  10PCS	Three-in-one sticker C  10PCS	

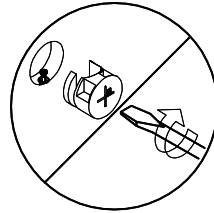
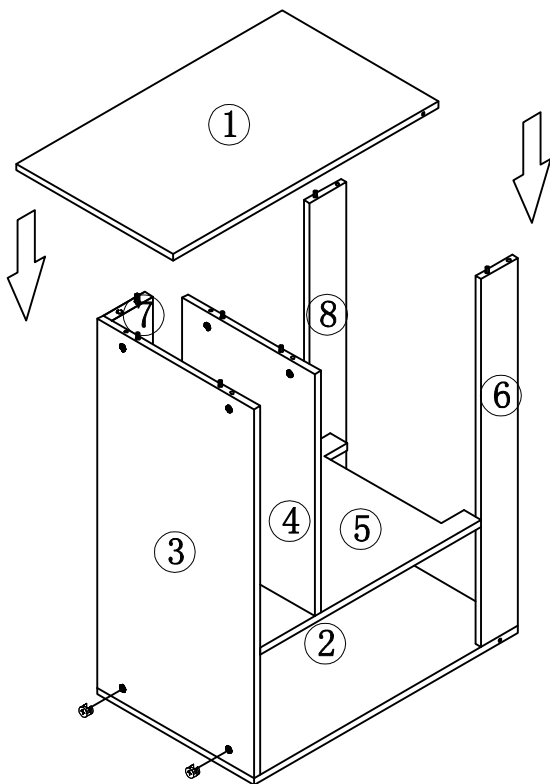

STEP 6

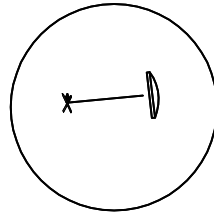

1. Connect No. 1 panel to No. 3-4-6-7-8 panel tightly with the three-in-one eccentric wheel.





2. Cover the mounting hole of the eccentric wheel with a three-in-one sticker.

HARDWARE LIST		
Three-in-one eccentric wheel A  7PCS	Three-in-one sticker C  7PCS	

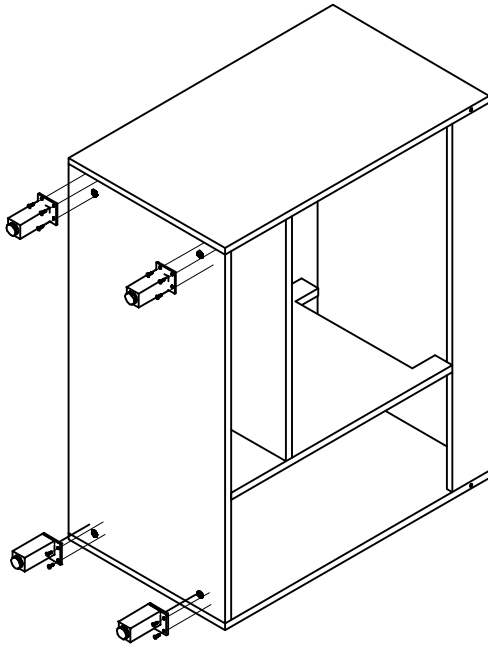
STEP 7

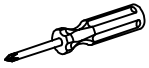

1. Fix feet of the cabinet with 4*16mm screws.

HARDWARE LIST		
4*16mm screw	Aluminum alloy leg	
F  12PCS	K  4PCS	

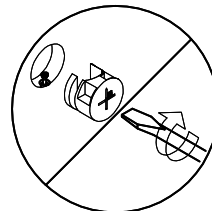
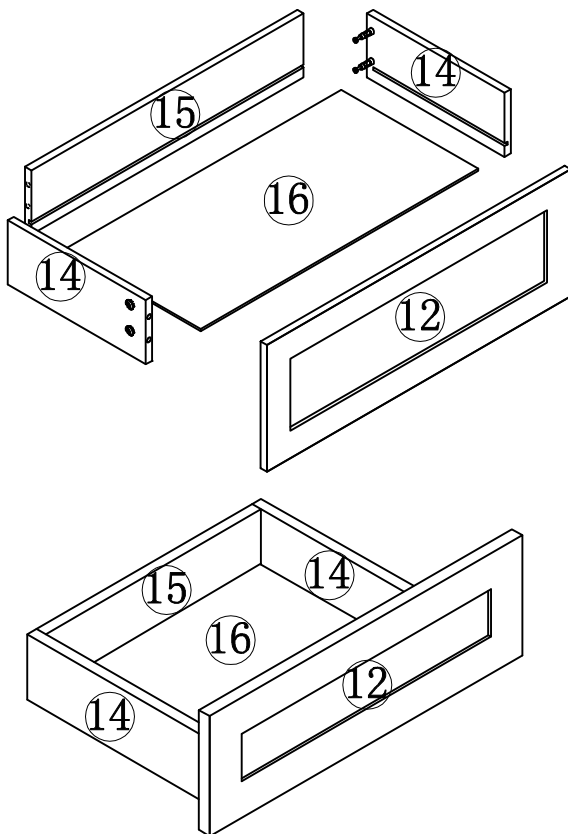

STEP 8

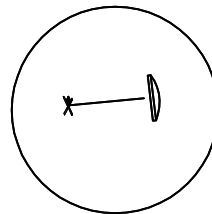

1. Install No. 12-14-15-16 panels with the three-in-one eccentric wheel tightly.

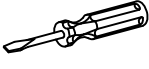

2. Cover the mounting hole of the eccentric wheel with a three-in-one sticker.

HARDWARE LIST		
Three-in-one eccentric wheel	Three-in-one sticker	
A  8PCS	C  8PCS	

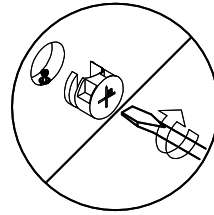
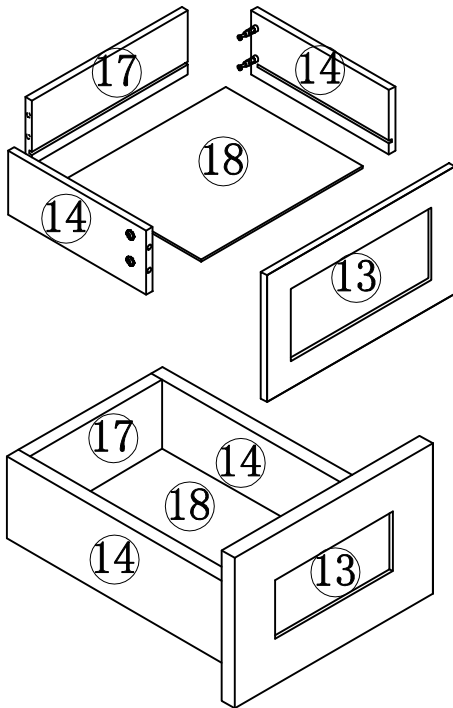

STEP 9

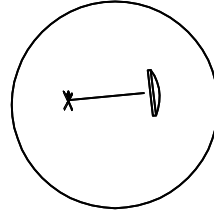

1. Install No. 13-14-17-18 panels with the three-in-one eccentric wheel tightly.





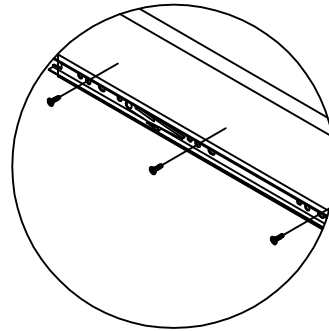
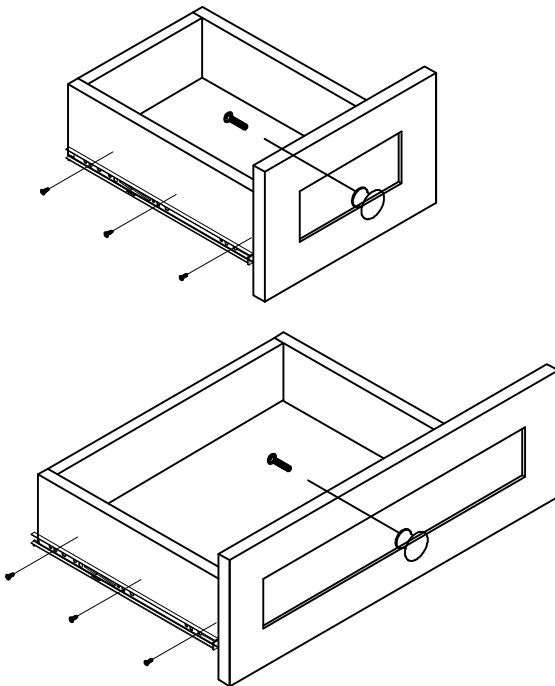

2. Cover the mounting hole of the eccentric wheel with a three-in-one sticker.

HARDWARE LIST		
Three-in-one eccentric wheel A  32PCS	Three-in-one sticker C  32PCS	

STEP 10



1. Lock the spare drawer slide block to the drawer.
2. Install the drawer handle with 4*18 handle screws.

HARDWARE LIST		
4*16mm screw F  30PCS	Drawer slides E-2  10PCS	
4*18mm screw H  5PCS	Drawer handle J  5PCS	

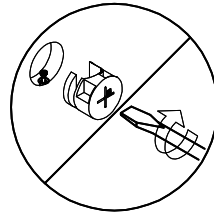
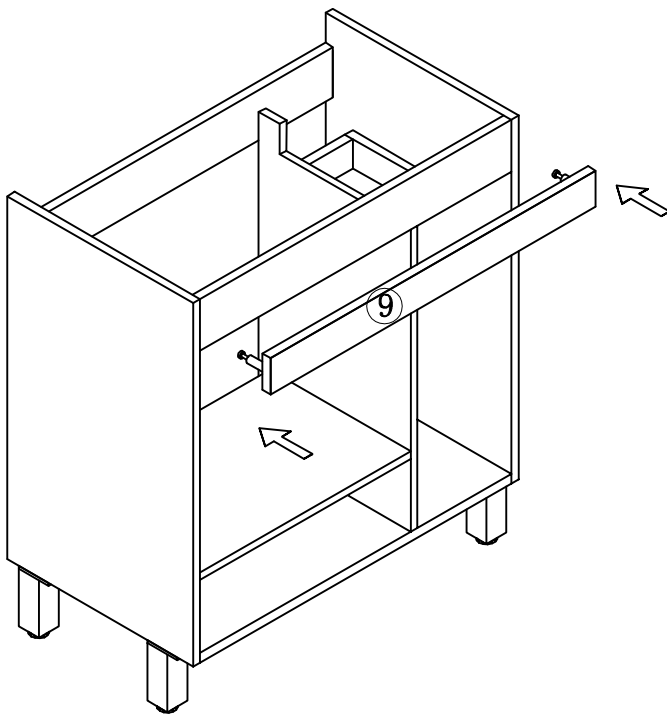

STEP 11

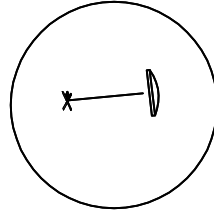

1. Install No. 9 panels with the three-in-one eccentric wheel tightly.



2. Cover the mounting hole of the eccentric wheel with a three-in-one sticker.

HARDWARE LIST		
Three-in-one eccentric wheel A  2PCS	Three-in-one sticker C  2PCS	

STEP 12

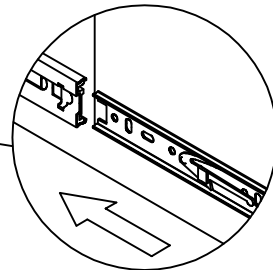
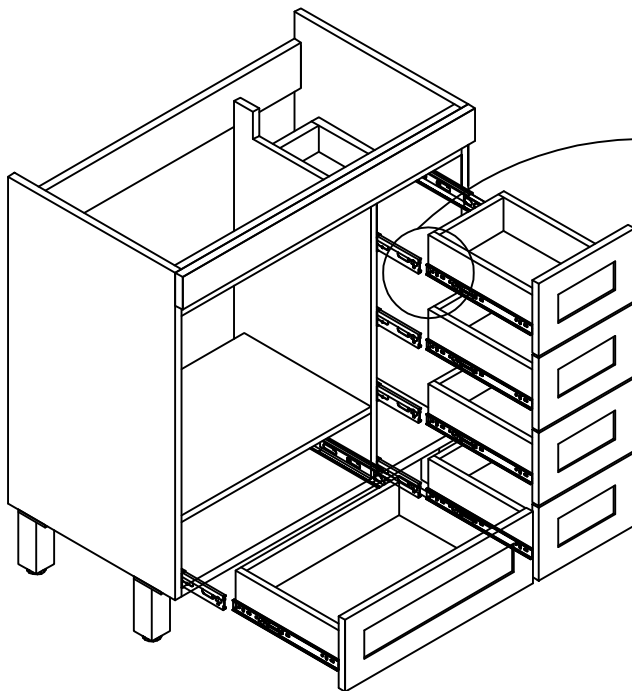

1. Align slide block with the trough on the guide rail, press the snap switch and press it forward to install the drawer.

2. Install drawer handles.

STEP 13

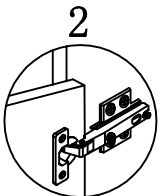
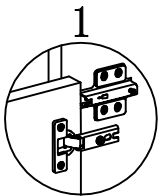
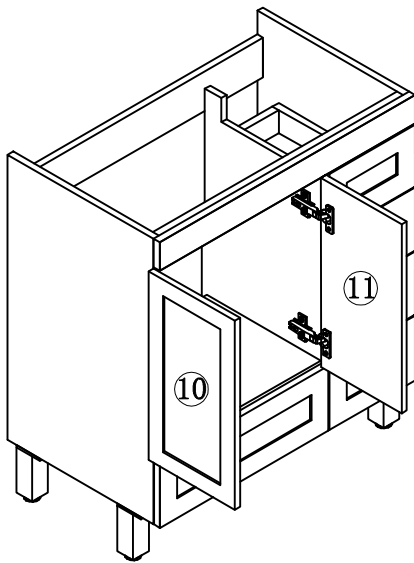

3. Install the hinge cup on the door panel to the hinge of the side panel.

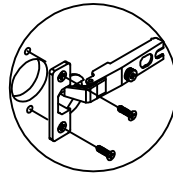

1. Install the hinge cup to the door panel with 4*16mm screws.

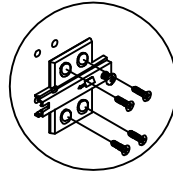

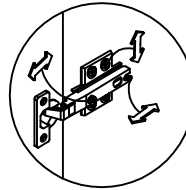

2. Install the hinge to the side panel with 4*16mm screws.

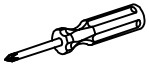

4. Adjust the door panel clearance.

HARDWARE LIST

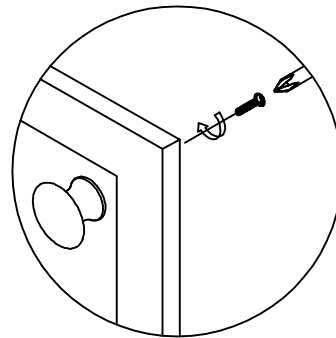
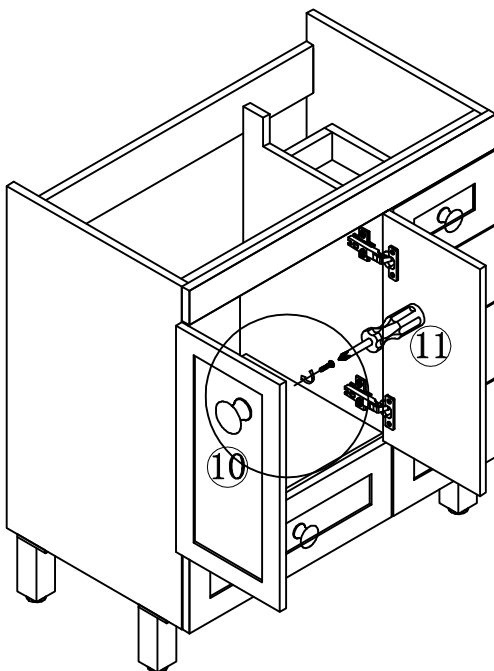

4*16mm screw	Door hinge	
F  24PCS	L  4PCS	

STEP 14



1. Install the door handle with 4*23 handle screws.

HARDWARE LIST

4*23mm screw	Door handle	
G  2PCS	I  2PCS	



Choking hazard-Small Parts : This unit contains small parts, not for children under 3 years.

Tip-over hazard : Secure finished unit to wall stud using L-Bracket and wall screw (#10*1.5"W/out provided). If a wall stud is not neccessible , Consault your local hardware store for appropriate mounting hardware . Failure to properly install will result in product collapse or tip-over. Serious injury can occur .