

WARRANTY

We strive to offer high-quality products, and we also try our best to satisfy each and every customer that orders from us with product or service as needed. We provide 30 days warranty starting from the time you receive the item. Each customer must provide a record of their order such as the order number, or item receipt for any items that are out of the warranty period you may also still receive replacement parts by purchasing them with our company if they are available.

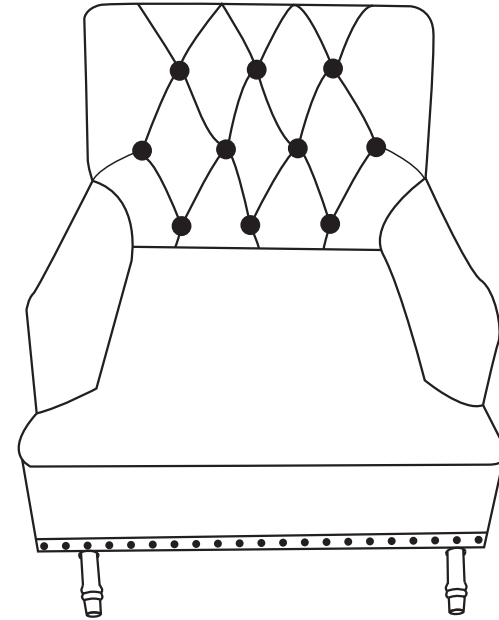

NOTE:

This brochure contains IMPORTANT safety info. Please read and keep for future reference.

MAINTENANCE AND WARNING

- Keep furniture away from heat.
- Do not clean furniture with harsh cleansers or polish. Do not use detergents, Solvents, abrasives, spray packs or leather cleaner. Use non-color mild soap with warm water clean spills(Mix 1:10 soap to water)
- Do not place furniture under direct sunlight, material will possibly fade over time.
- Do not use on site dry Cleaning machine.
- Children should not climb or jump on the furniture.
- Do not write on furniture without a padded barrier to protect the surface.
- Not for commercial use, For residential use only.



Weight Limitation

250LBS

PARTS LIST

Ax1

Backrest

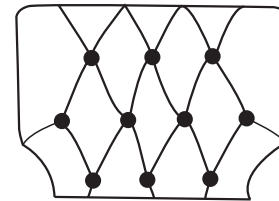

Bx1

Seat Cushion

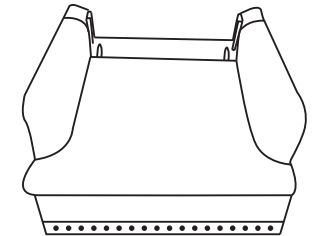

Cx2

Fore foot



Dx2

Back Foot

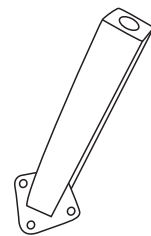

HARDWARE LIST

Ex14

M6*20mm
Screw

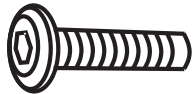

Fx1

M6
Spanner

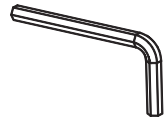

SPARE

Ex1

M6*20mm
Screw

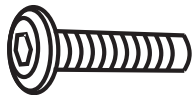

Be sure to check all packing material carefully for small parts, which may have come loose inside the carton during shipment.

ASSEMBLY INSTRUCTIONS

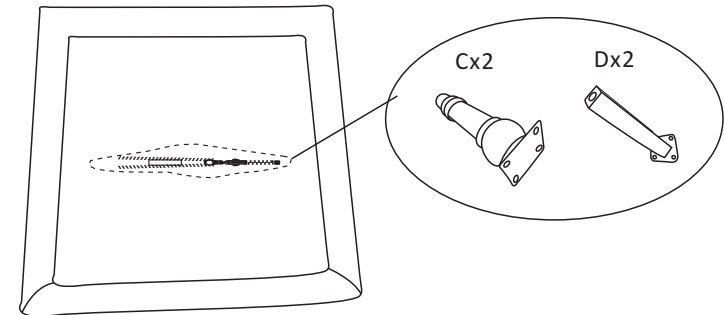

STEP 1: Open the zipper pocket under the seat and take the legs C, D out.

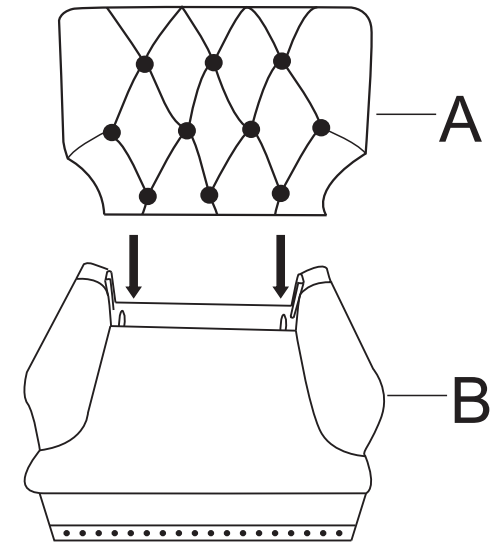

STEP 2: Carefully align male and female bracket then push the back all the way down to secure.

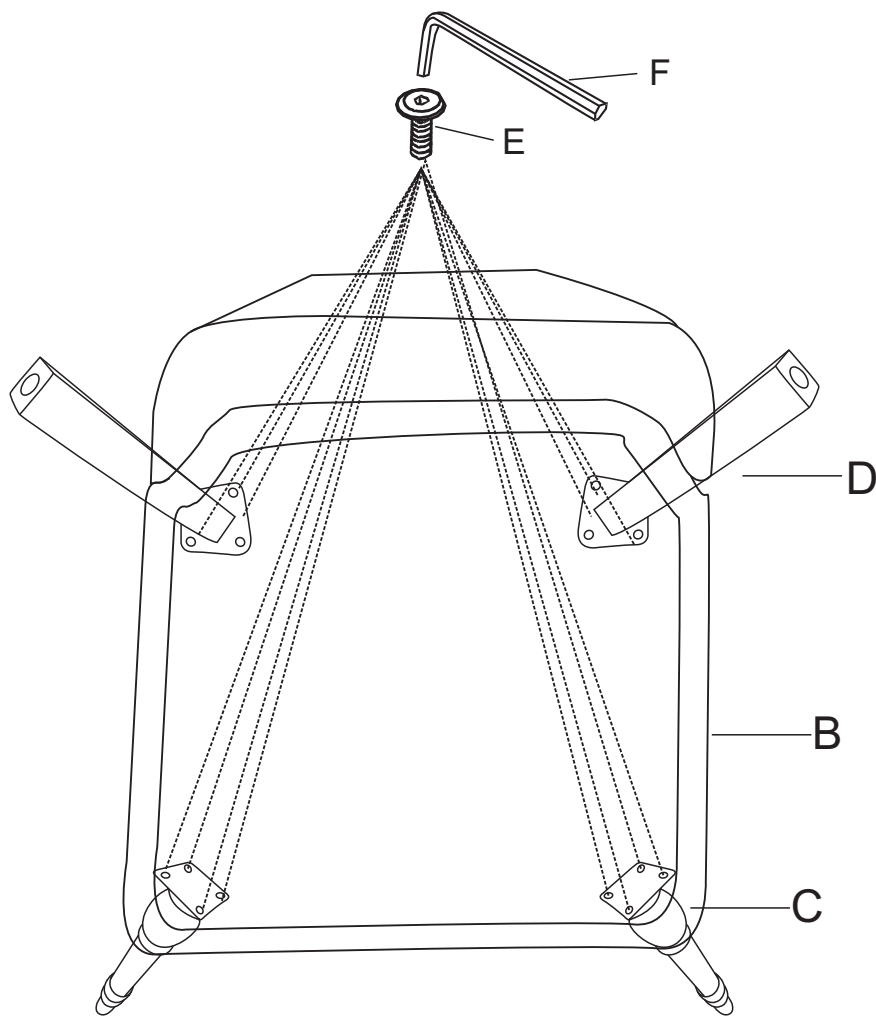

Place the chair seat/back assembly on clean padded surface.

STEP 3 :Use bolt E, allen key F to connect the leg C/D to bottom of the seat cushion B, make sure all holes align, fasten all bolts to secure.

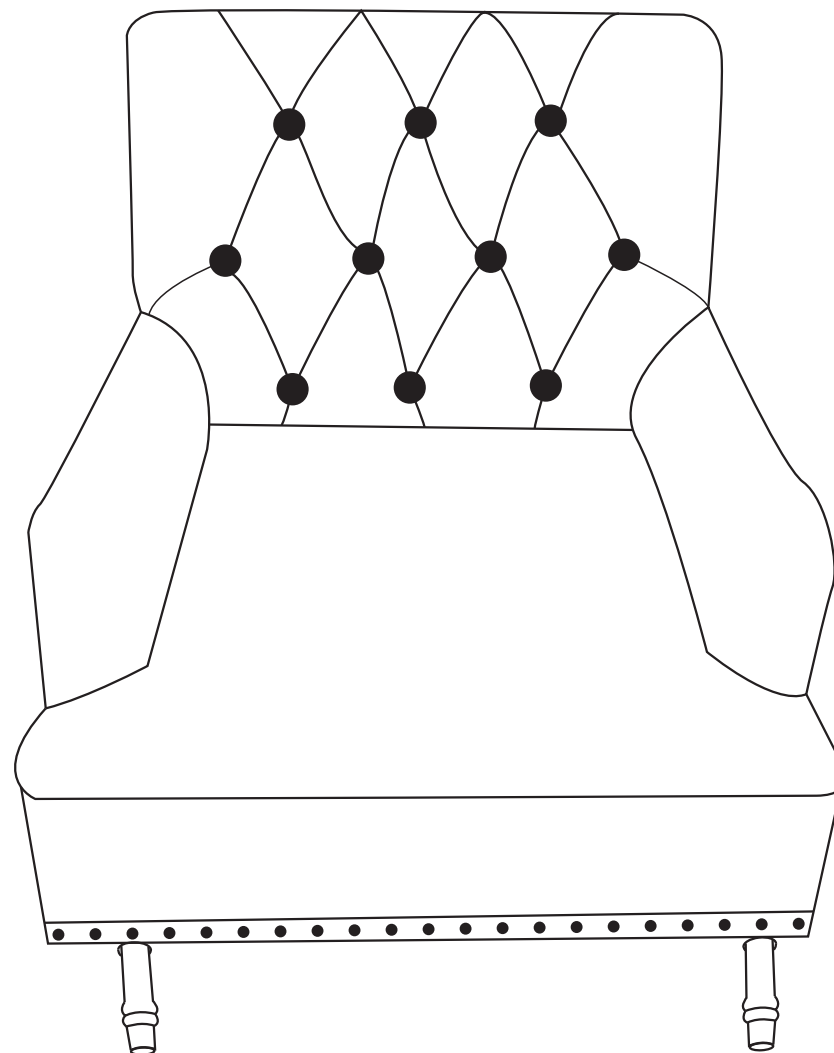

STEP 4 :Assembly completed.