

WARNING (To reduce the risk of fire, electric shock, or injury to persons):

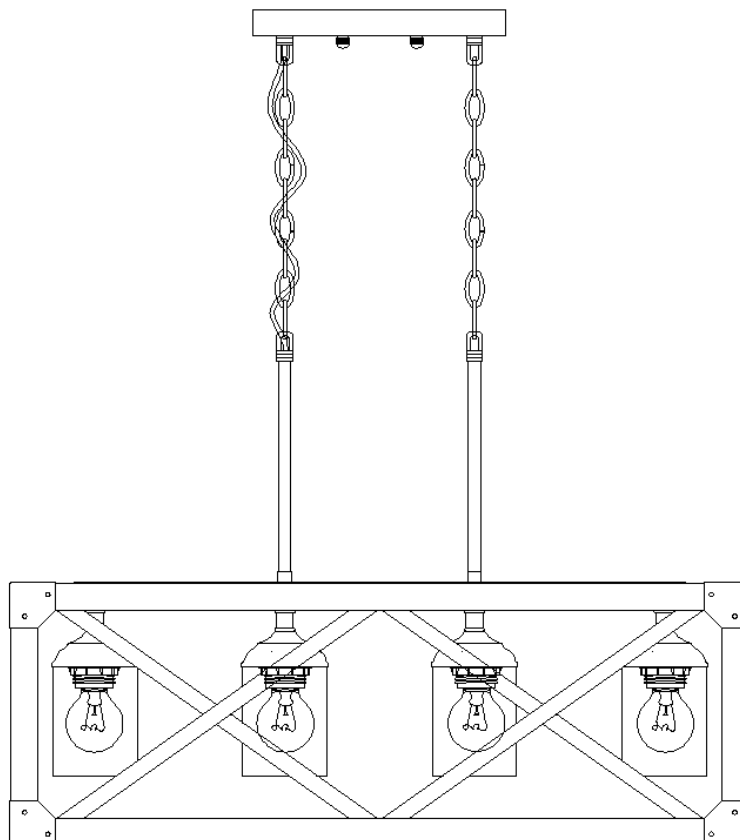



1. We suggest installation by a **licensed electrician**.
2. Please read the instruction carefully and save it as you may need it at later time.
3. Before you start, **NEVER** attempt any work without shutting off the electricity until the work is done. A). Go to the main fuse, or circuit breaker, box in your home. Place the main power switch in the “**OFF**” position. B). Place the wall switch in the “**OFF**” position.
4. Mounting surface should be clean, dry, flat, strong enough and 1/4” larger than the canopy on all side. Any gaps between the mounting surface and canopy exceeding 3/16” should be corrected as required.
5. Make sure that the ceiling or wall can stand the weight of the lamp before fixture.
6. Make sure the voltage you are using is **120V**. The maximum wattage is **60W** per bulb.
7. Keep the lamp away from acidic and basic objects in case of damaging the surface of the lamp.
8. When replacing bulb, you should turn off or unplug the lamp and you must wait until it is cool as bulbs get hot quickly.
9. The safety instructions appearing in this manual are not meant to cover all possible conditions that may occur. It must be understood that common sense, caution and care must be used with any electrical products.

IMAGE FOR FINISHED PRODUCT:



TOOLS REQUIRED (NOT INCLUDED):

Before doing assembly and installation please prepare the needed tools as below picture

				
Ladder	Phillips head, flat blade screwdriver	Electrical tape	Pliers	Wire cutter/Stripper

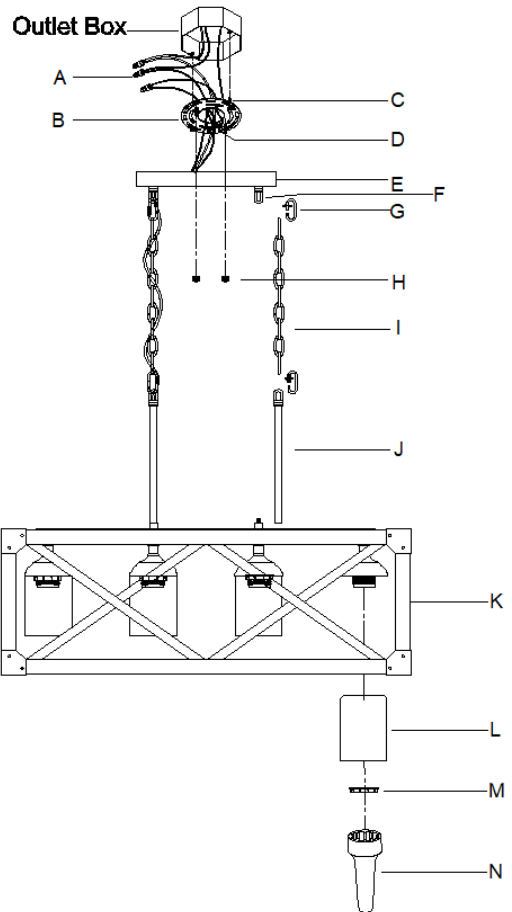

PARTS TYPE & QTY INCLUDING:

- (B) Mounting plate assembly (1)
- (D) Green ground screw (1)
- (E) Canopy (1)
- (F) Loop (4)
- (G) Quick link (4)
- (H) Ball knob (2)
- (I) Chain (2)
- (J) Tube (2)
- (K) Fixture (1)
- (L) Glass shade (4)
- (M) Socket ring (4)



ACCESSORIES & QTY ENCLOSED:

- (A) Plastic wire connector (3)
- (C) Mounting screw (2)
- (N) Spacer tool (1)

A	C	N
		

Line art shown may not exactly match the fixture enclosed. However, the installations do apply to this fixture.

ASSEMBLY & INSTALLATION INSTRUCTIONS:

1. Carefully remove the fixture from the carton and check that all parts and accessories are included as shown in the above illustration

2. Make assembly

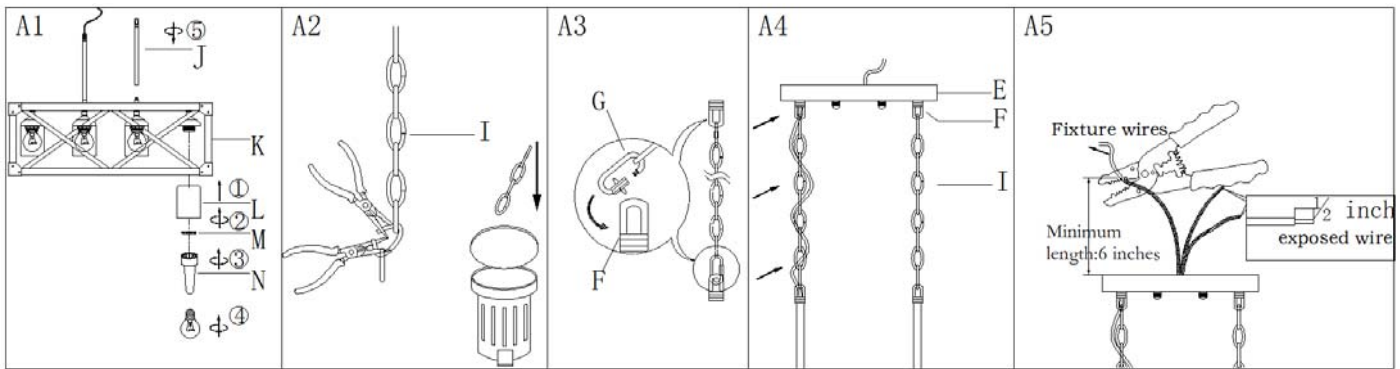

STEP A1: Place the glass shade (L) onto the socket of fixture (K) then use the spacer tool (N) to thread the socket ring (M) onto the socket to secure the glass shade in place.

Install bulb (not included) (Please do not exceed the maximum capacity recommended on the socket.)

Thread the tube (J) onto the top of fixture (K) till snug.

STEP A2: By measuring, determine the correct number of links needed for proper hanging height. Using the chain pliers, disconnect and discard the remaining chain.

STEP A3: Attach the quick link (G) to connect the chain (I) and the loop (L) of canopy (E)

Attach the quick link (G) to connect the chain (I) and the loop (L) of tube (J)

STEP A4: Carefully lace the wires through the chain (I) (every other link) and stop just before you reach the top of chain (I), then carefully pass the fixture wires through the loop (F) and the canopy (E).

Gently pull the wires till snug.

STEP A5: If needed, cut off the wires length of fixture (K). At this point, the remaining wire length measured from the top of canopy is at least 6".

3. Turn off power.

Before you start to make installation, NEVER attempt any work without shutting off the electricity until the work is done.

A). Go to the main fuse, or circuit breaker, box in your home. Place the main power switch in the "OFF" position. B).

Place the wall switch in the "OFF" position.

4. Make installation

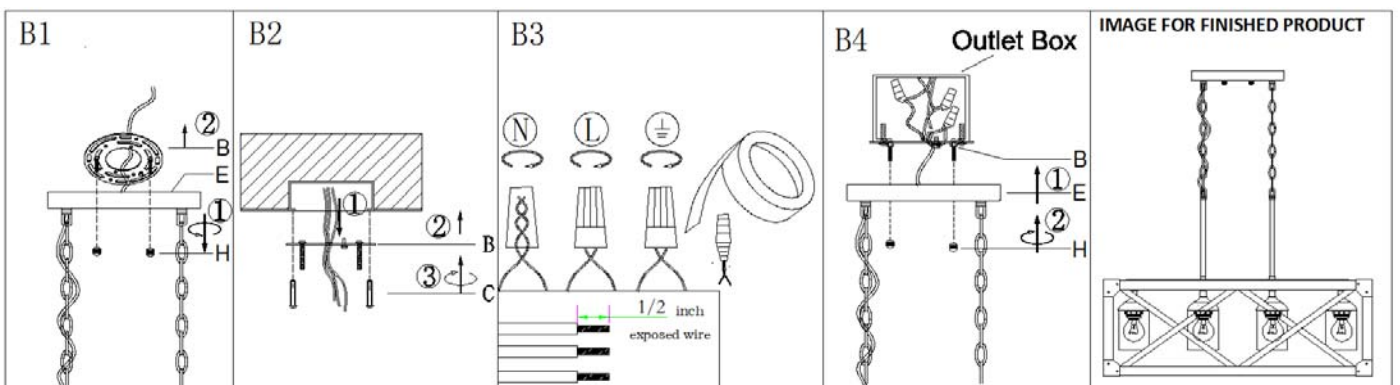

STEP B1: Unscrew the ball knobs (H) from canopy (E) then gently remove the mounting plate assembly (B)

STEP B2: Carefully pass the outlet box wires through the mounting plate (B), then secure the mounting plate assembly (B) to outlet box with the mounting screws (C)

STEP B3: Make wire connections

Connect wires as below wires connecting shown. **TAKE NOTE OF YOUR COLOR OF FIXTURE ,NEVER CONNECT WIRES TO GROUND WIRES**

Connect ground wire according to below chart

Connect wires according to below chart

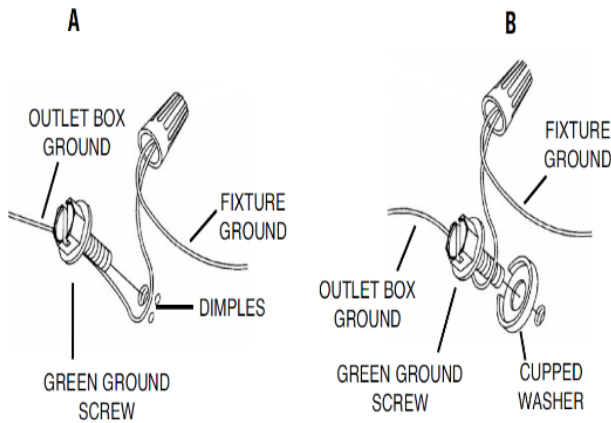

Connect Black or Red Supply Wire to:	Connect White Supply Wire to:
Black	White
*Parallel cord (round & smooth)	*Parallel cord (square & ridged)
Clear, Brown, Gold or Black without tracer	Clear, Brown, Gold or Black with tracer
Insulated wire (other than green) with copper conductor	Insulated wire (other than green) with silver conductor

*Note: When parallel wires (SPT I & SPT II) are used. The neutral wire is square shaped or ridged and the other wire will be round in shape or smooth (see illus.)

Twist plastic wire connector(A) until wires are tightly joined together,wrap each connector with approved electrical tape for more secure connection and carefully stuff all wires into the outlet box

STEP B4:Align the holes in the canopy (E) with the mounting screws, then attach the canopy (E)using the previously removed ball knobs (H). Hand tighten until snug.

5. Check everything already is installed properly, then you could turn on the light. Enjoy!

CLEANING

To clean, wipe fixture with a soft cloth. Clean glass with a mild soap. Do not use abrasive materials such as scouring pads or powders, steel wool or abrasive paper.

ORDERING PARTS

Keep this sheet for future reference, and in case you need to order replacement parts. All parts for this fixture can be ordered from place of purchase. Be sure to use exact wording from illustration when ordering parts.