

Top View

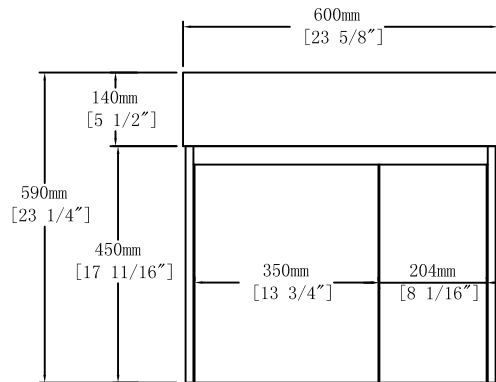

Front View

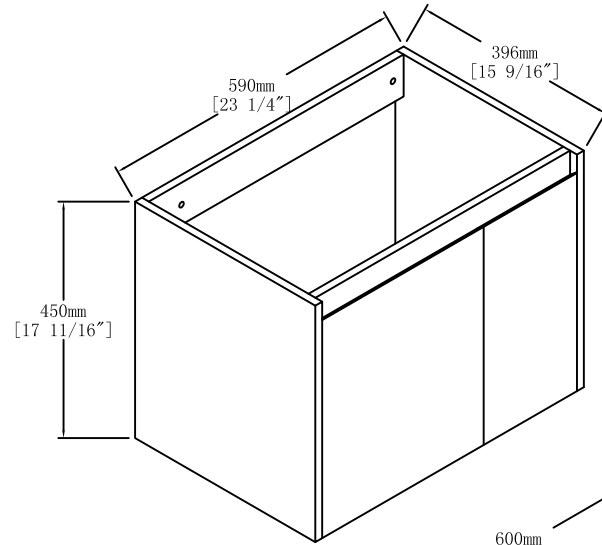
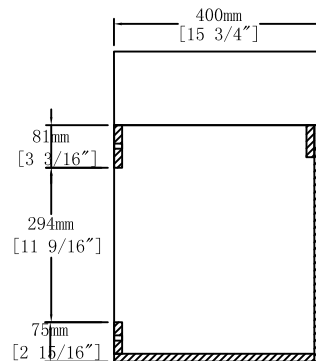

Side View

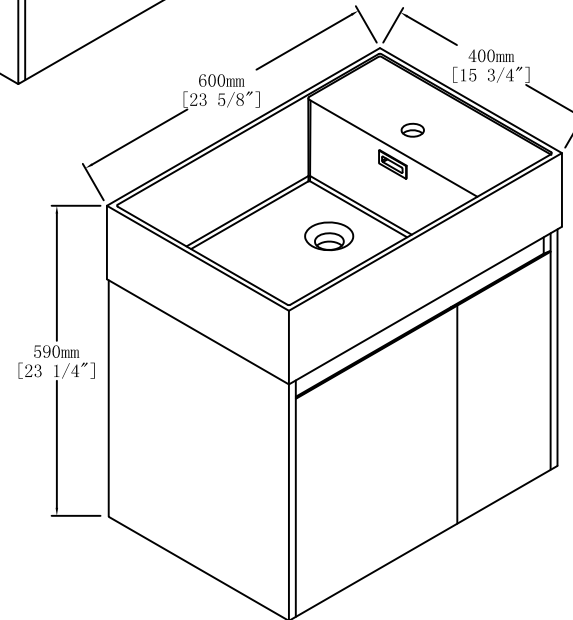

Item NO.	BV B09324
Project	

Version	V1
Date	2024-6-14