

Outdoor Storage Shed 10X8ft Manual

Tips: Take care of sharp edges, please wear gloves, it will take 2 people 3-4 hours to install.

Dear customer,
Thank you for your support. If you have any questions or concerns, please don't hesitate to contact us. Our customer service team is always here to help and assist you in any way we can. Thank you again for choosing our product.

Street: 8 The Green Suite A
City: Dover
State: DE
Post code: 19901
Phone: +1-3022415039/6605538327
Email: aftersale@sannwsginc.com
Scan the code on your phone
and contact us via email



sannwsg.com

After-sales phone service hours:
US Central Time: 19:00-23:00
Seattle Time: 17:00-21:00
US Eastern Time: 20:00-00:00
Toronto Time: 20:00-00:00
Germany Time: 8:00-11:00
After-sales mailbox service time:
7*24 hours

Street: 8 The Green Suite A
City: Dover
State: DE
Post code: 19901
Phone: +1-3022415039/6605538327
Email: aftersale@sannwsginc.com
Scan the code on your phone
and contact us via email







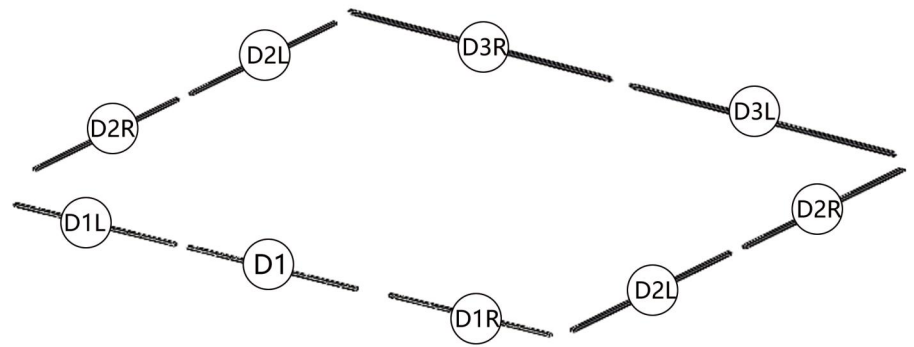
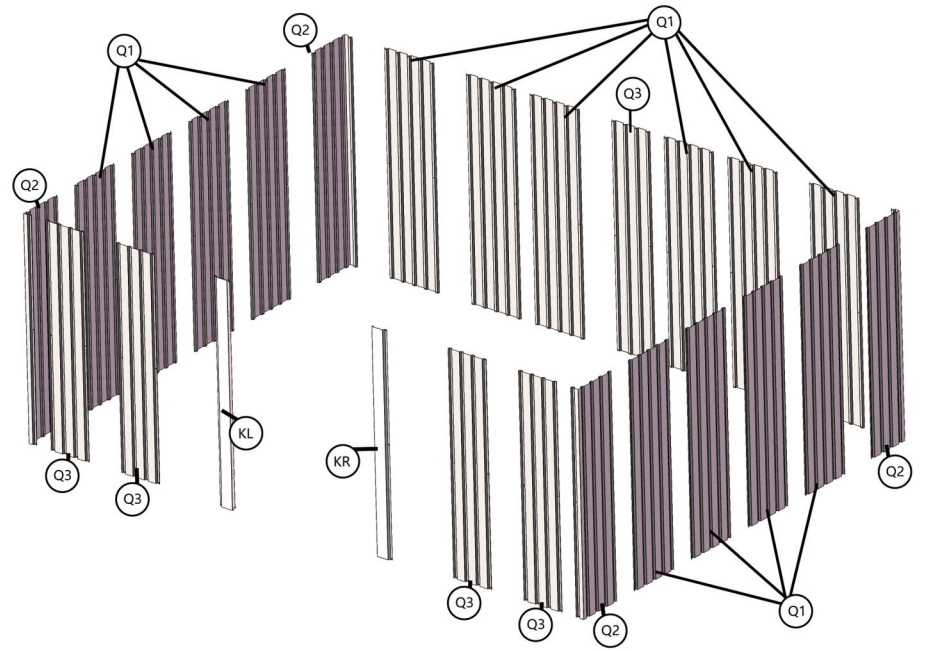
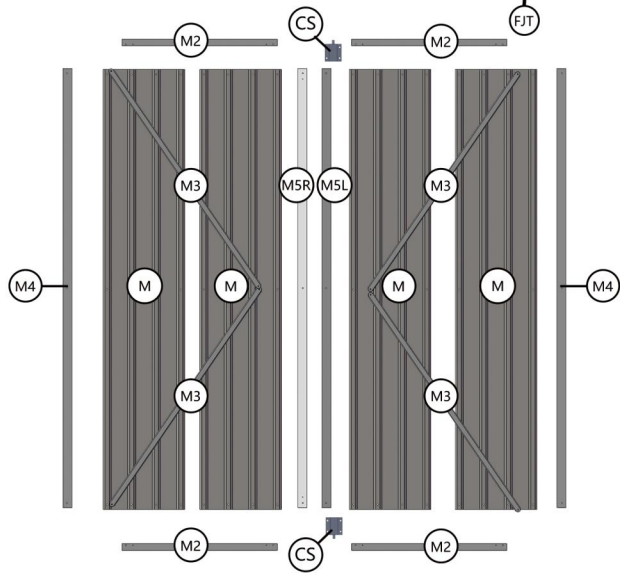
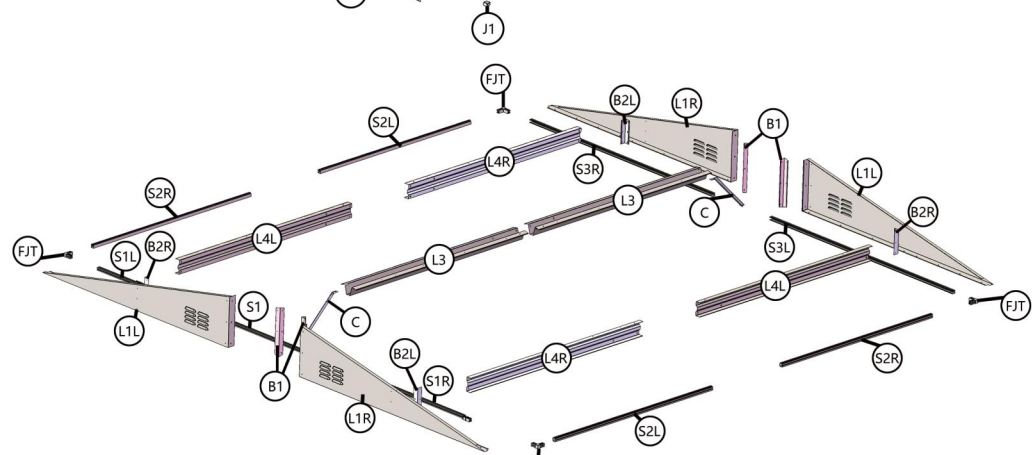
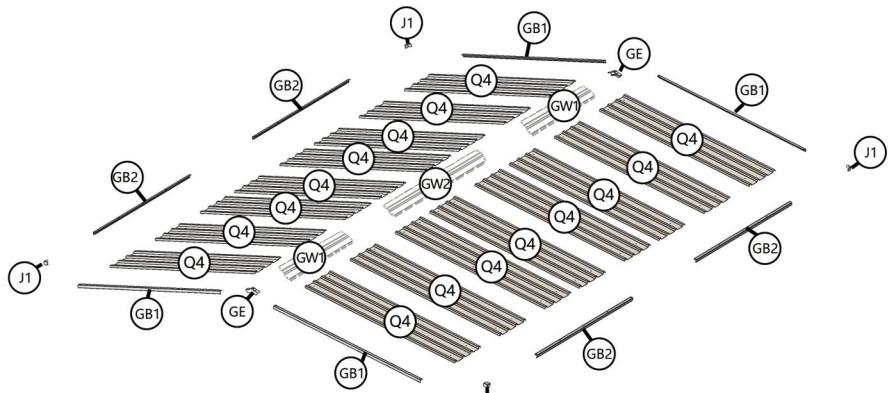



























sannwsg.com













After-sales phone service hours:
US Central Time: 19:00-23:00
Seattle Time: 17:00-21:00
US Eastern Time: 20:00-00:00
Toronto Time: 20:00-00:00
Germany Time: 8:00-11:00
After-sales mailbox service time:
7*24 hours







PARTS LIST



NO1	PART	QTY
D1		1
D1R		1
D1L		1
D2R		2
D2L		2
D3L		1
D3R		1
S1		1
S1L		1
S1R		1
S2R		2
S2L		2
S3L		1
S3R		1
KL		1
KR		1



NO1	PART	QTY
L1L		2
L1R		2
B1		4
B2L		2
B2R		2
C		2
L3		2
L4L		2
L4R		2
GB1		4
GB2		4
GW1		2
GW2		1
M2		4
M3		4
M4		2

NO1	PART	QTY
M5L		1
M5R		1
Q1		14
Q2		4
Q3		5
Q4		16
M		4
J1		4
FJT		4
GE		2
SK		1
HY		4
CS		2

PARTS LIST

NO1	PART	QTY
F1		420
F8		9
LSM		75
F14		400

NO1	PART	QTY
F3		28
F10		20

NO1	PART	QTY
F4		18
F11		22

Install LSM at screw exposure, Prevent collisions.

This part is used with all screws, Such as F1 and F3, located in the external tool room Easy to seal and waterproof.

Warning & Attention:

-Take care of sharp edges; Please wear gloves;

-All the tags except the foundation are facing inward

-You are advised to read the whole procedure before installing it

-Try to assemble this product on the flat ground, otherwise it is difficult to carry out;

-It would be much easier to assemble the product with three or more people;

-All panels are clearly marked and care should be taken to use the correct one. It is important that these instructions are followed step by step;

-After assembly, please check whether all screws are tightened, to prevent parts from falling apart.

Tools:



Gloves



Ladder



Electric drill



Phillips screwdriver



Safety Helmet Hat



Goggles

Unit: mm

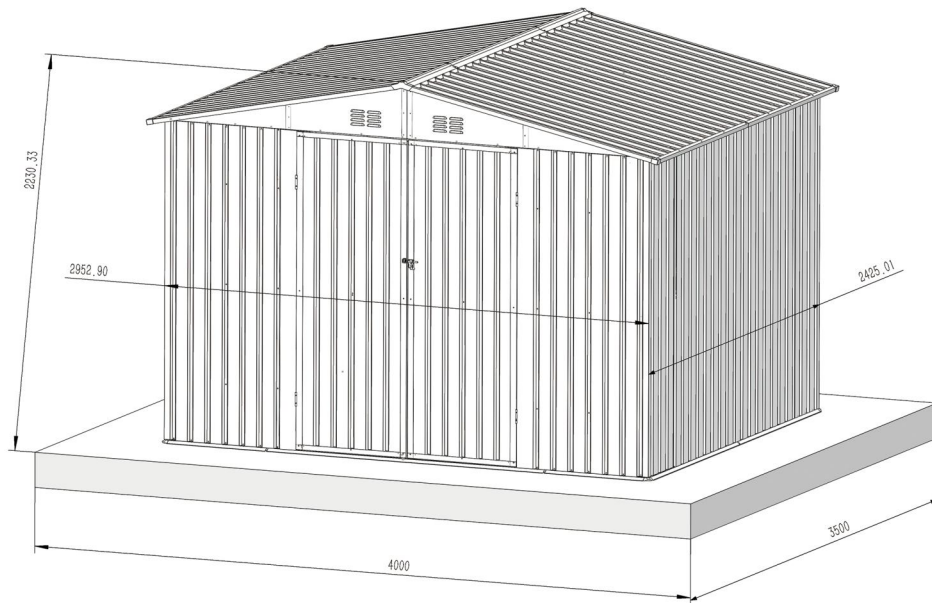

NO.	PART	Qty.	NO.	PART	Qty.	NO.	PART	Qty.	NO.	PART	Qty.
D1		1	D2R		2	D3L		1	F14		28
D1L		1	D2L		2	F1		28			
D1R		1	D3R		1	F8		9			

tips: All F1 and F14 should be used together.
The following steps are not explained.

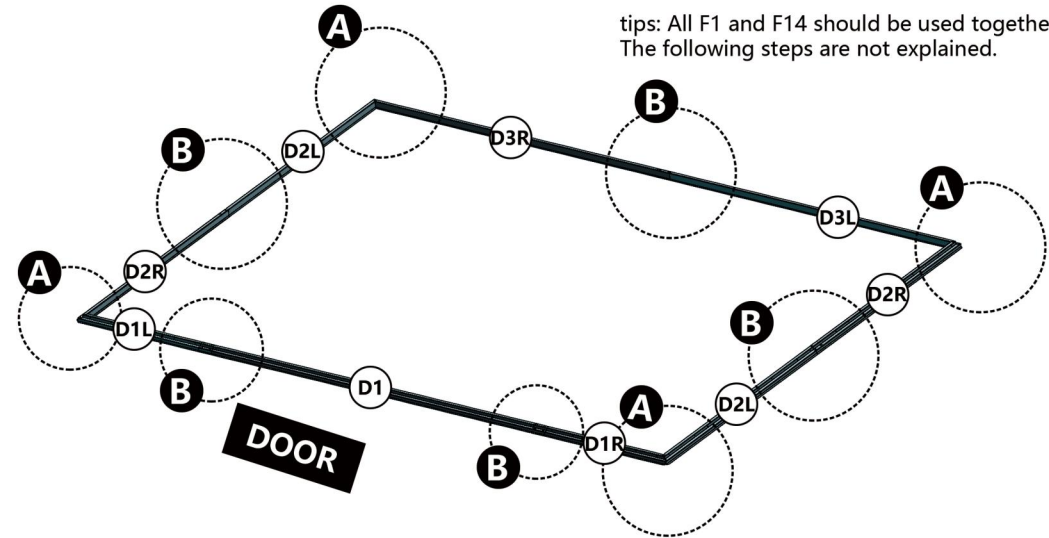

Notice:

A: The base frame of the four corners is spliced together and fixed with F1 as shown in the picture.

B: Splice the foundation at point B, align the holes, and secure with F1.

F8 Installation: After the overall installation is completed, if it is a mud floor, please install the F8 to the position shown in the figure, and the expansion screws can be installed on other floors.



The installation space should be flat, and at least 4000x3500mm. The foundation is fixed on the ground in this space.

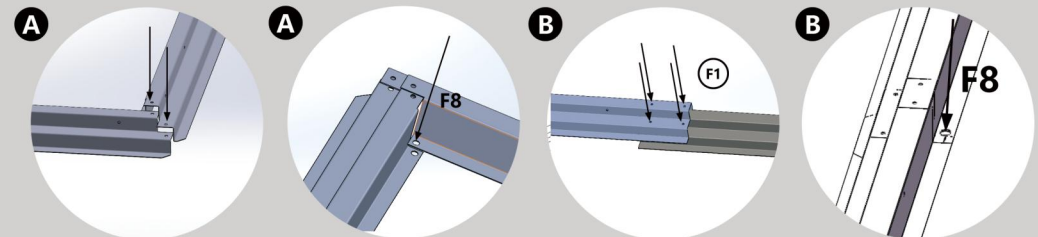

NO.	PART	Qty.
S1R		1
S1L		1
S1		1

NO.	PART	Qty.
S2L		2
S2R		2
S3L		1

NO.	PART	Qty.
S3R		1
F1		13
FJT		4

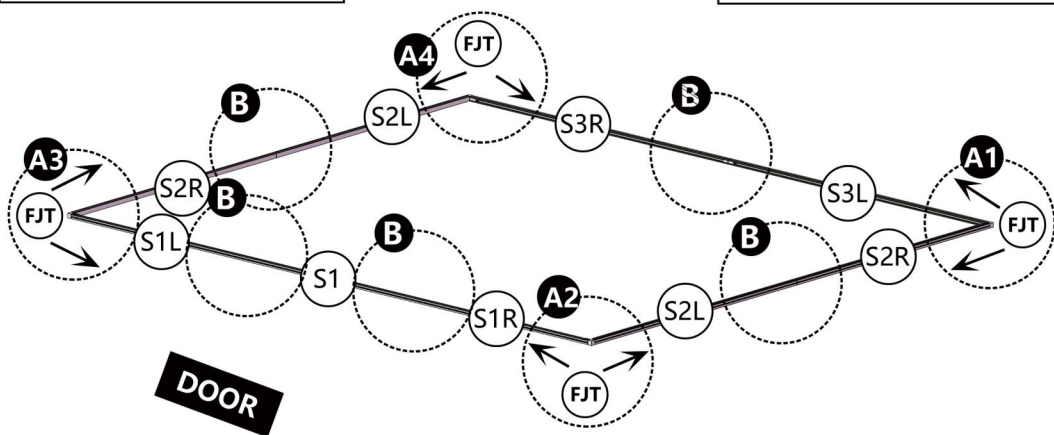
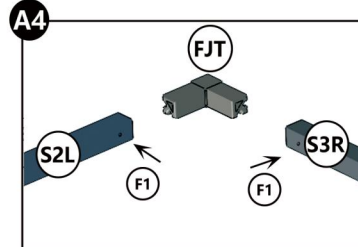
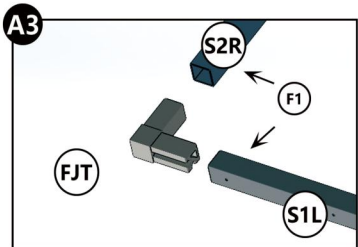

Notice:
 A: FJT is installed at the junction of two arrows, please install the direction indicated by the arrow (→←), fix it with F1 after installation.
 B: Connect two places as shown and fix them with F1.

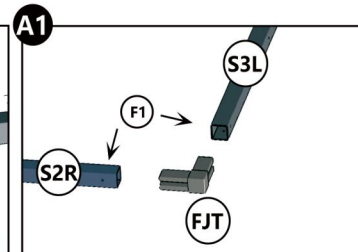
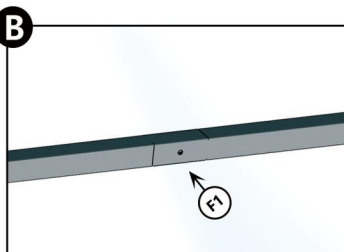
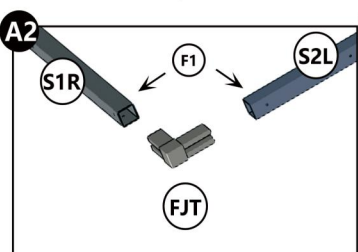

NO.	PART	Qty.
Q2		4
F1		12

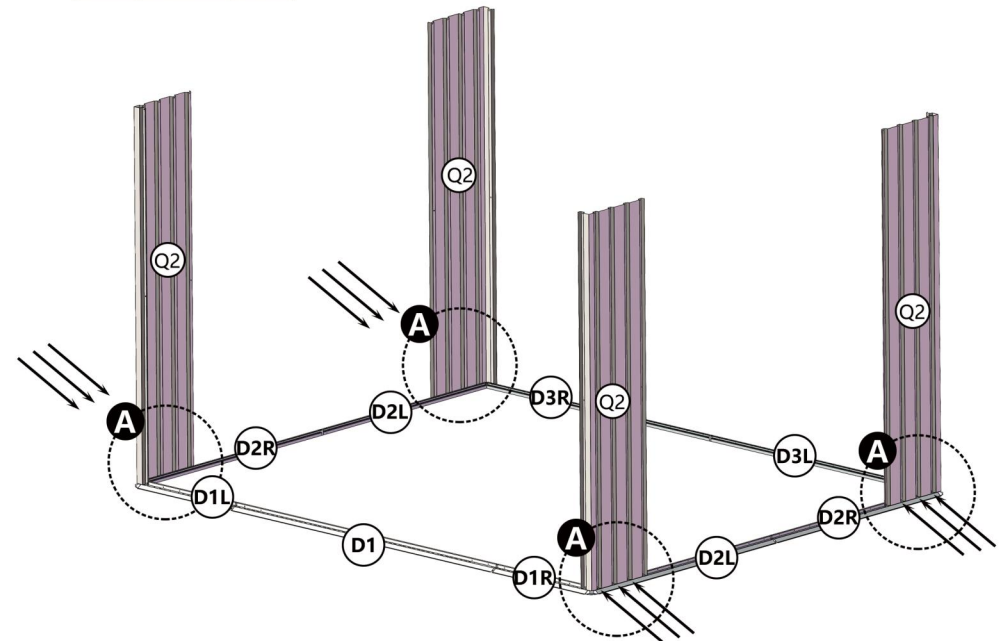



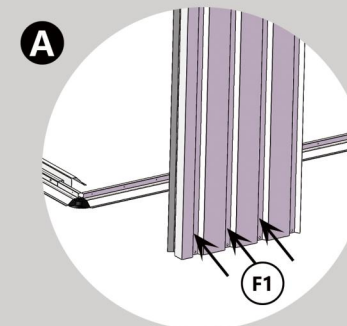

Notice:
 In this step, only the three holes in the middle of Q2 need to be installed and reserved on both sides. The reserved holes are shared with the following steps.

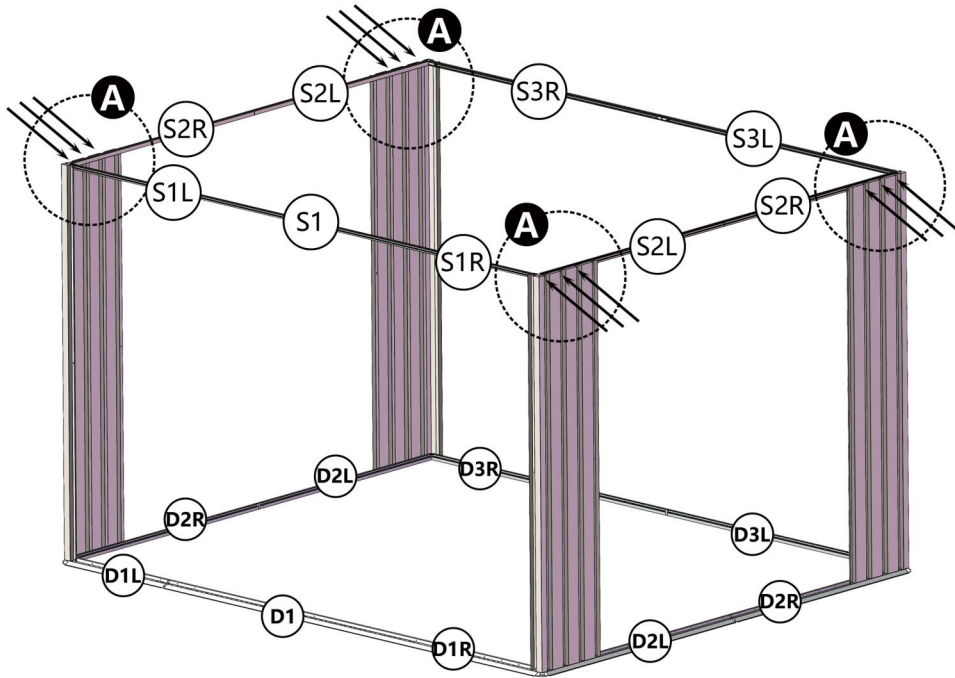

NO.	PART	Qty.
F1		12





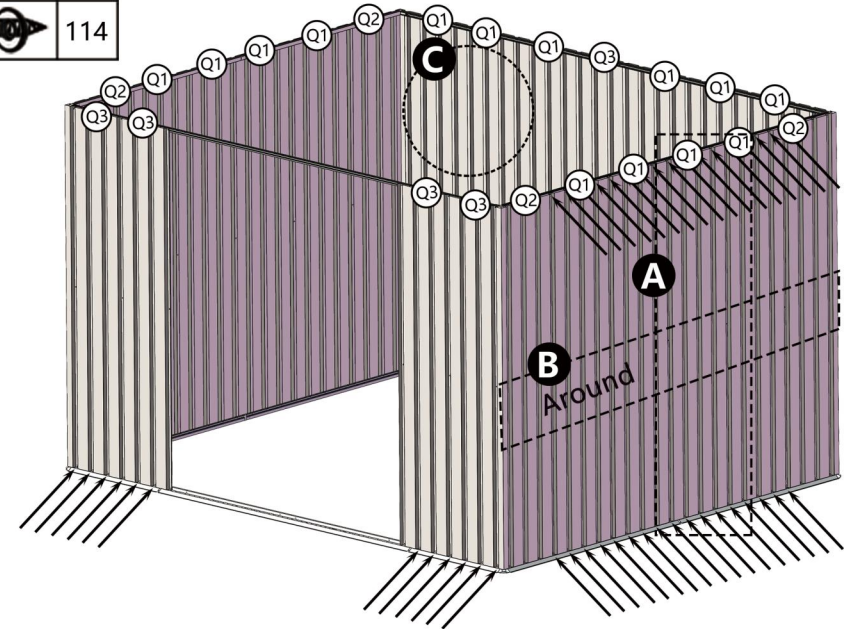

Notice:
 In this step, only the middle three holes need to be installed, and both sides need to be reserved.
 The reserved hole is shared with other steps.
 The walls are tiled on the outside and framed on the inside

NO.	PART	Qty.
Q1		14
Q3		5
F11		20
F1		114

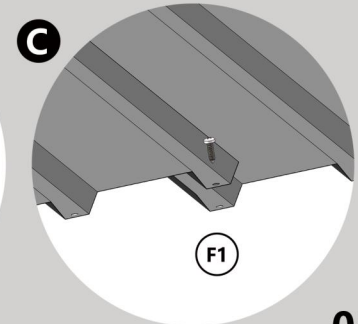
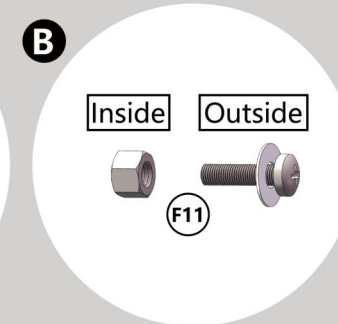
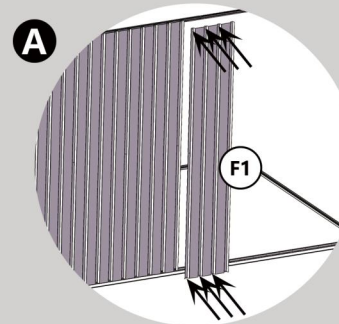
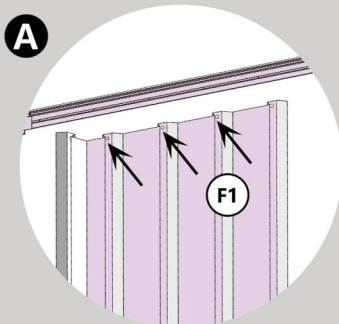

Notice:
 As shown in the picture, assemble the wall tiles in turn, Q1\Q3, The top, middle and bottom of the wall tiles need to be screwed,
 The upper and lower ends are fixed with F1, and the middle is fixed with F11.
 (Reserve the required hole positions for the next wall panel)





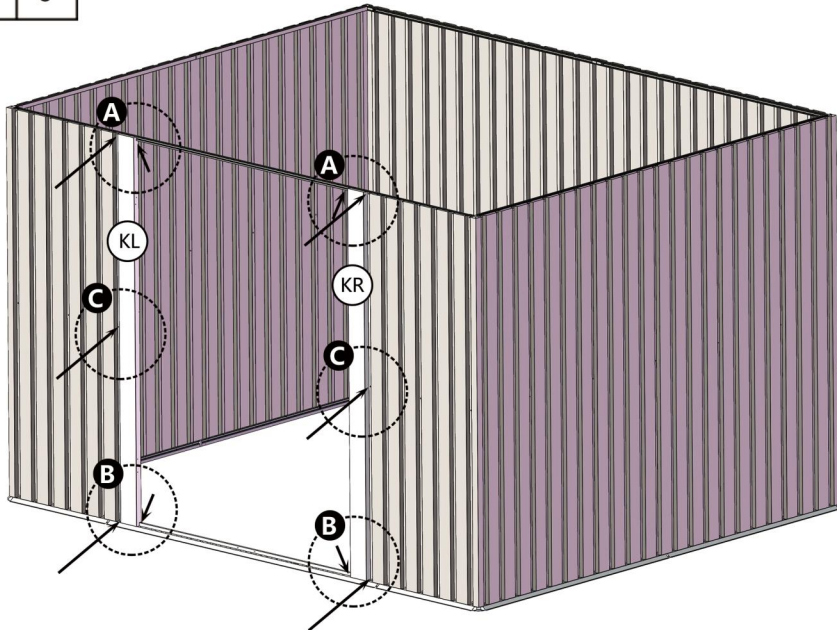



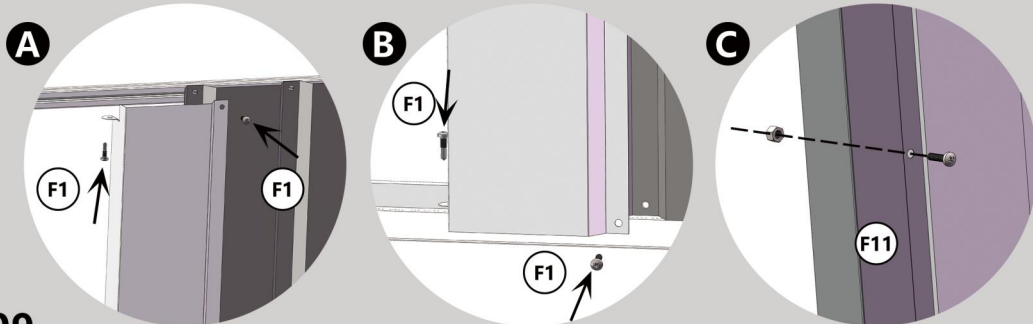

NO.	PART	Qty.	NO.	PART	Qty.
KL		1	F11		2
KR		1			
F1		8			



Notice:
 As shown in the picture, the steps of door frame and wall tile installation are the same.
 The upper, middle and lower parts of KR and KL need screws.
 The upper and lower ends are fixed with F1(the hole position should be manually bent 90 degrees first) and F1, and the middle is fixed with F11.



NO.	PART	Qty.	NO.	PART	Qty.	NO.	PART	Qty.	NO.	PART	Qty.
B1		4	B2R		2	L1R		2	F3		6
B2L		2	L1L		2	C		2	F1		20

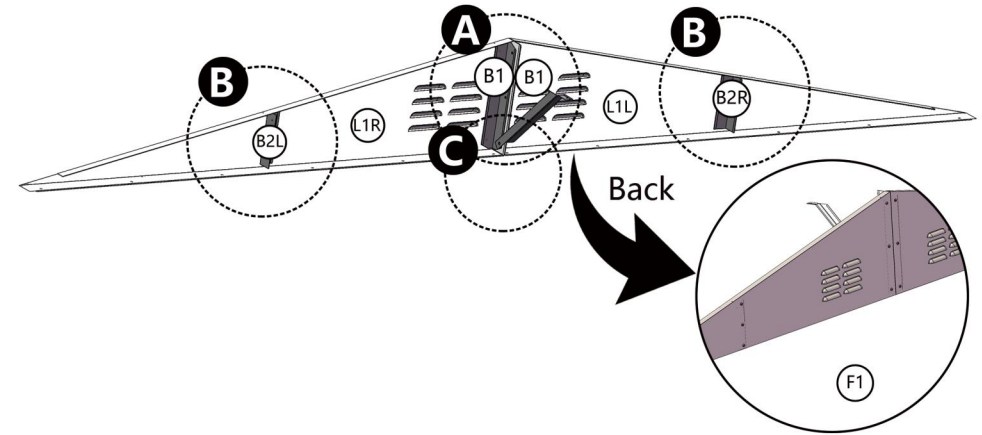

Notice:
 Step A: Connect L1L and L1R with 2 B1s, fix F3 (fix the top two holes first), There are holes on both sides of B1, and the large holes are 2 B1 and L1R and L1L connected together. The position of the small hole is 2 B1s, connected to L1R and L1L respectively, and fixed with F1 from the outside to the inside.
 Step B: Fix B2R and B2L to L1L and L1R with F1 as shown in the picture. There are holes on both sides of B2R and B2L, and the big holes of B2R and B2L connecting L1L and L1R. The small holes of B2R and B2L, connected to L1R and L1L respectively, and fixed with F1 from the outside to the inside.
 Step C: Install C into the bottom-most hole of B1 as shown in the diagram, and secure both B1, L1L, and L1R together using F3.

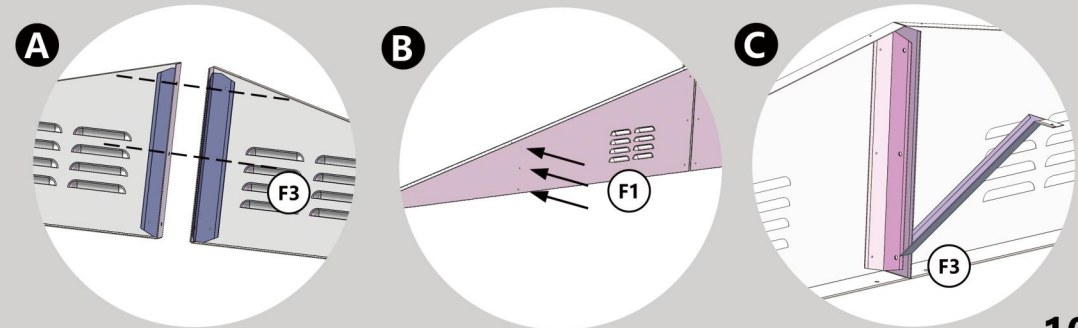



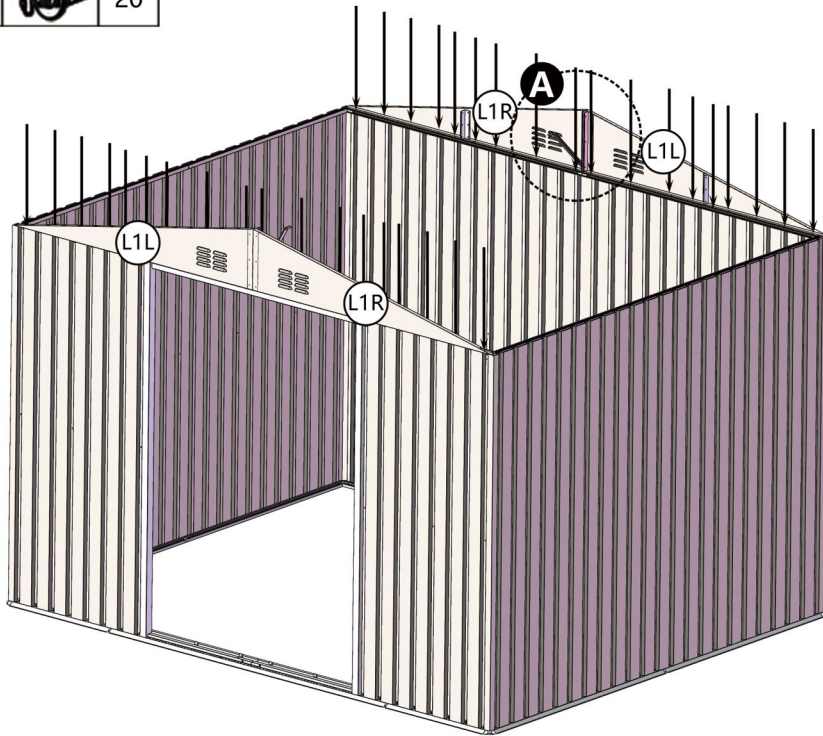

NO.	PART	Qty.
F1		20

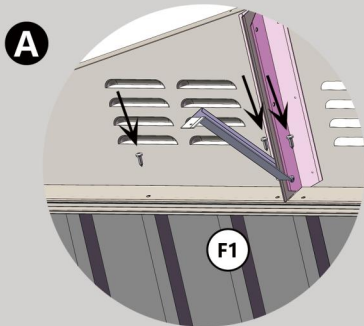

Notice:
Install the assembled roof support pieces on the wall tile in turn according to the holes, and fix them with F1.



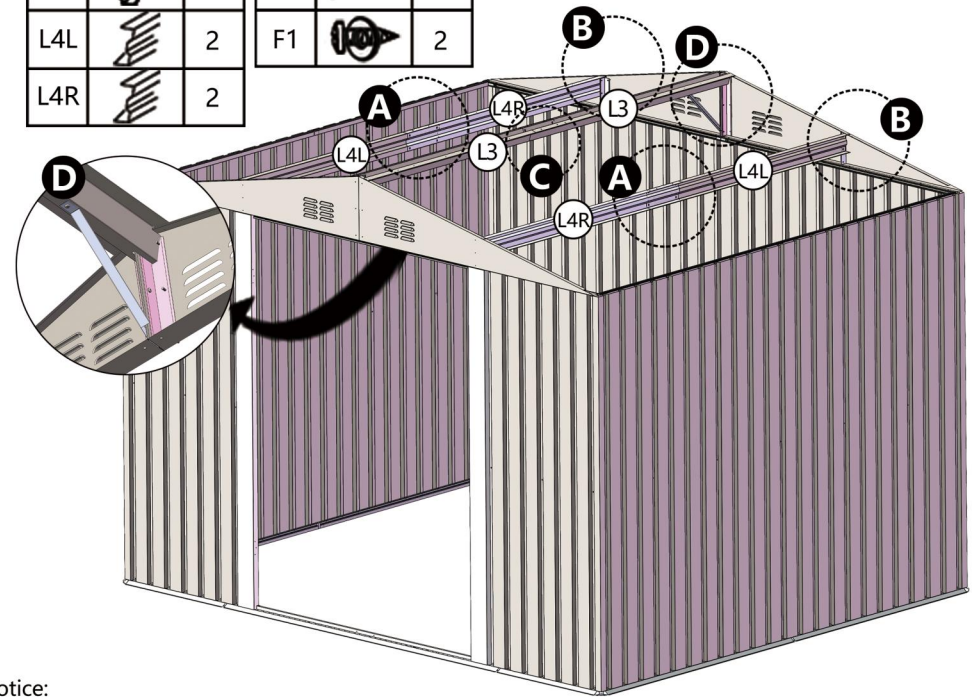

NO.	PART	Qty.	NO.	PART	Qty.
L3		2	F3		22
L4L		2	F1		2
L4R		2			

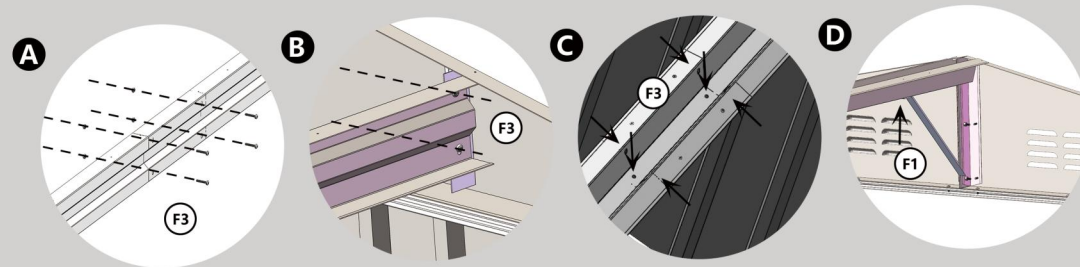

Notice:
Step A: Connect the L4R and L4L, and install the two sides outwards, as shown in the figure(opening outward).
Step B: Connect the connected L4R and L4L to the B2L and B2R large holes.
Step C: Connect 2 L3s and place them on L1R and L1L.
Installation is not required for the time being, and the holes are shared with Q4.
Step D: Bend one end of part C, install it on L3, and fix it with F1.



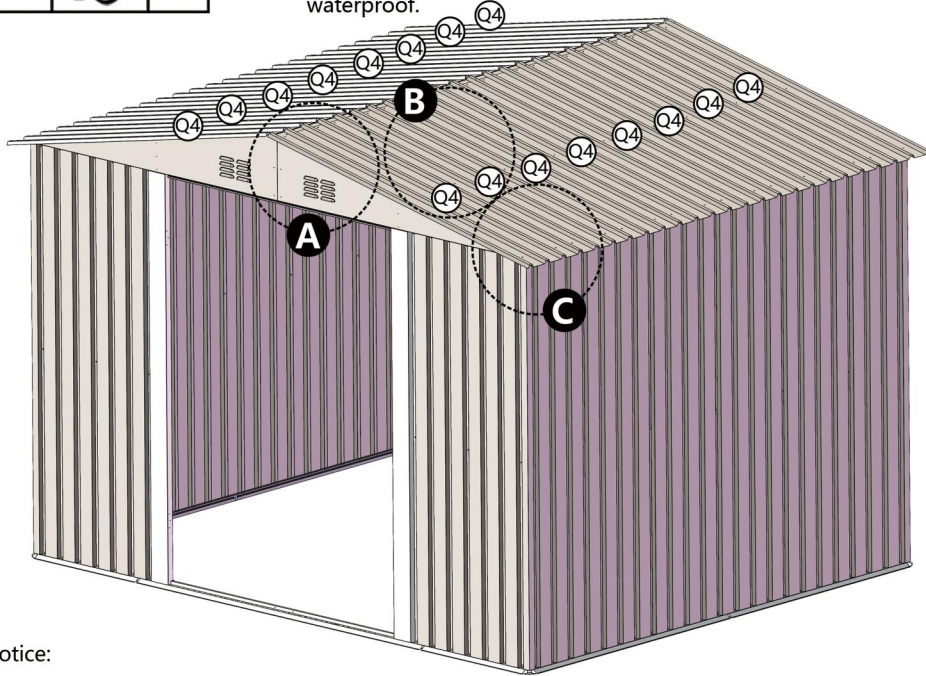

NO.	PART	Qty.
Q4		16
F1		96

Special note: The installation of F1 must add plastic gaskets, which can play the role of roof waterproof.



Notice:
 Q4 Installed in sequence, every 2 pieces overlap,
 There are 2 rows of holes in the tile, and the one near the edge is on the top, as shown in Figure A.
 The distance from the edge is far below, as shown in Figure C.
 Each Q4 requires a fixed 3 rows of F1, as shown in Figure ABC.

NO.	PART	Qty.
GW1		2
GW2		1

NO.	PART	Qty.
F1		4

Special note: The installation of F1 must add plastic gaskets, which can play the role of roof waterproof.

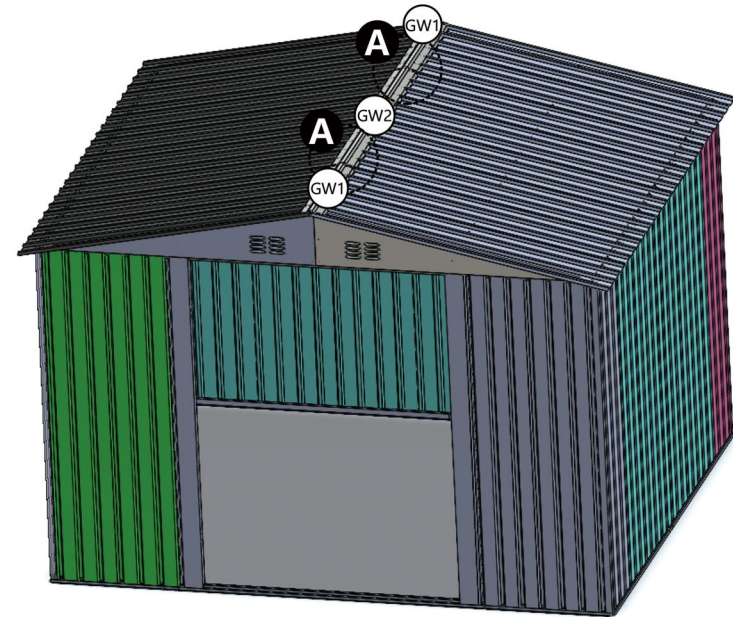

Notice:
 Step A: GW1, and GW2 are fixed at the top with F1.

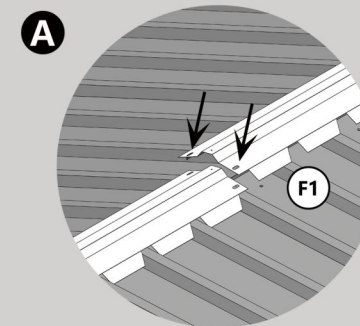
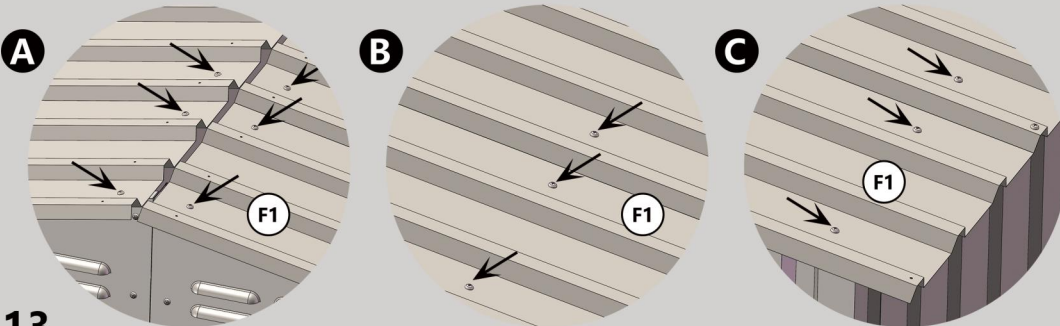

NO.	PART	Qty.	NO.	PART	Qty.
GB1		4	F1		24
GB2		4	J1		4
GE		2			

Special note: The installation of F1 must add plastic gaskets, which can play the role of roof waterproof.

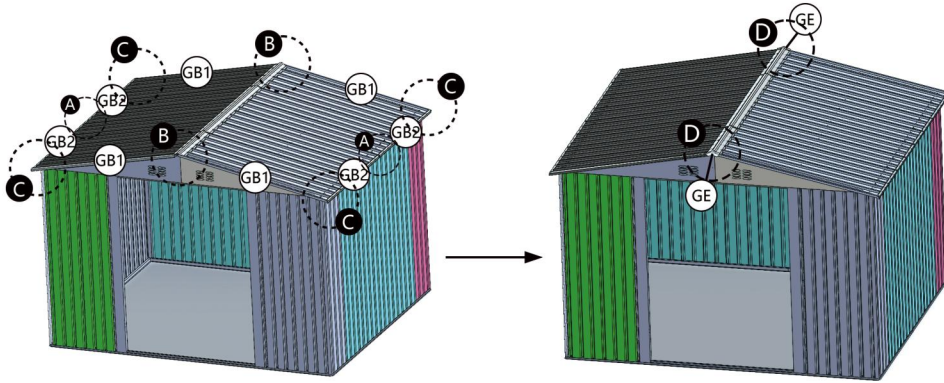

Notice:

A: Place GB2 on both sides of the roof. First secure both GB2 units to Q4 using F1, then secure the center hole of GB2 using F1.

B: Position GB1 at the front and rear of the roof. Use F1 to secure GW1, GB1, and Q4 together.

C: Take J1 and place it at each corner of the roof. Use F1 to simultaneously secure J1, GB1, GB2, and Q4 together.

D: Position GE at the front and rear ends of the roof. Use F1 to secure GE to GW1 from the top.

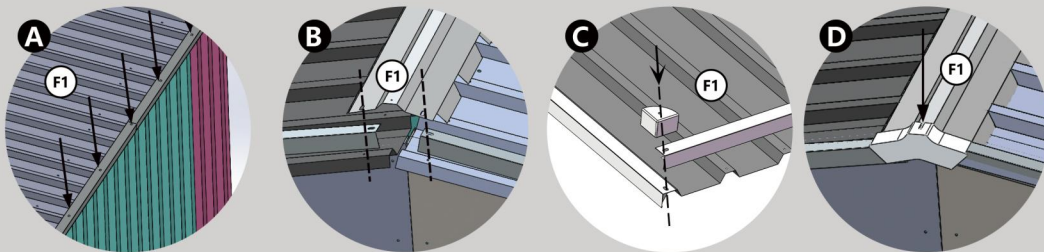

NO.	PART	Qty.	NO.	PART	Qty.	NO.	PART	Qty.	NO.	PART	Qty.
M2		4	M5L		1	SK		1	F1		10
M3		4	M5R		1	HY		4	F4		18
M4		2	M		4	CS		2	F10		20

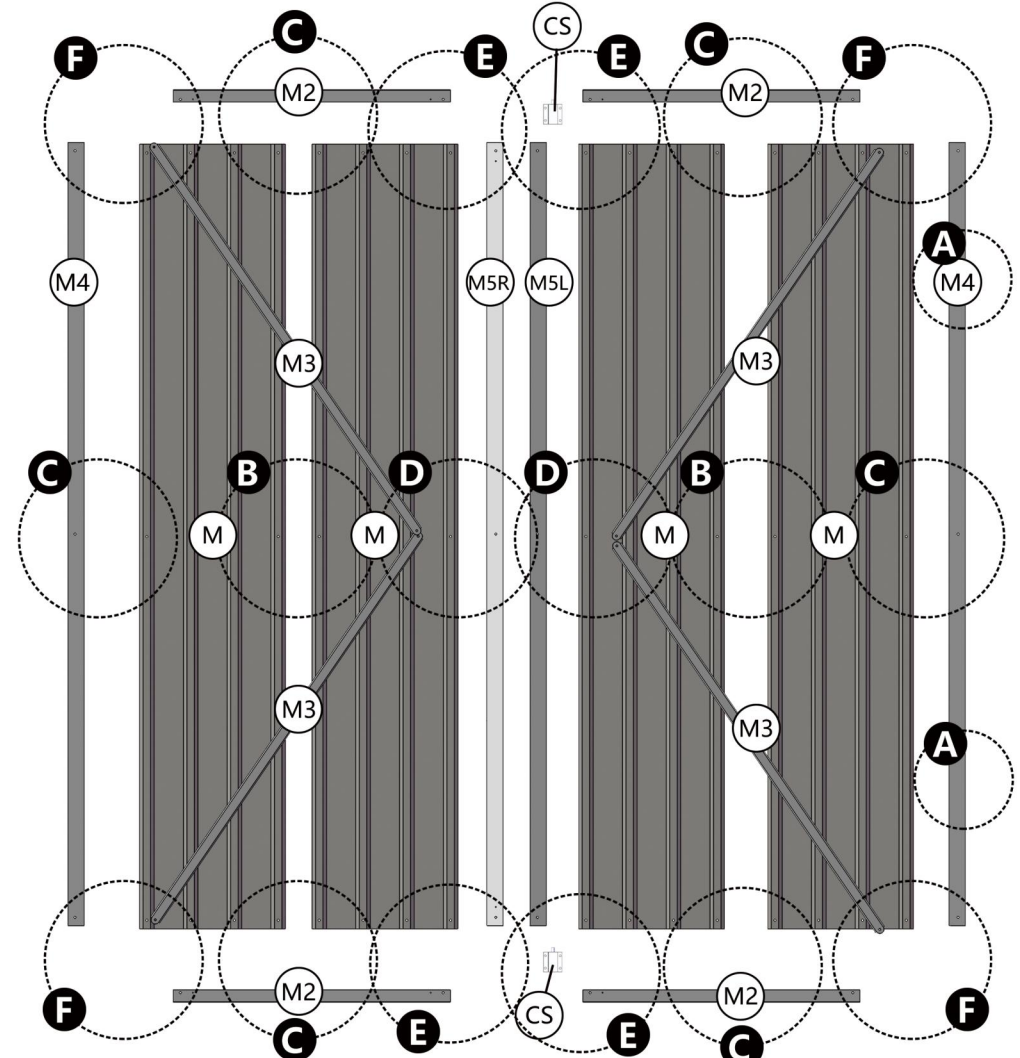

BACK

NO.	PART	Qty.
F4		18

NO.	PART	Qty.
F10		8

NO.	PART	Qty.
F11		2

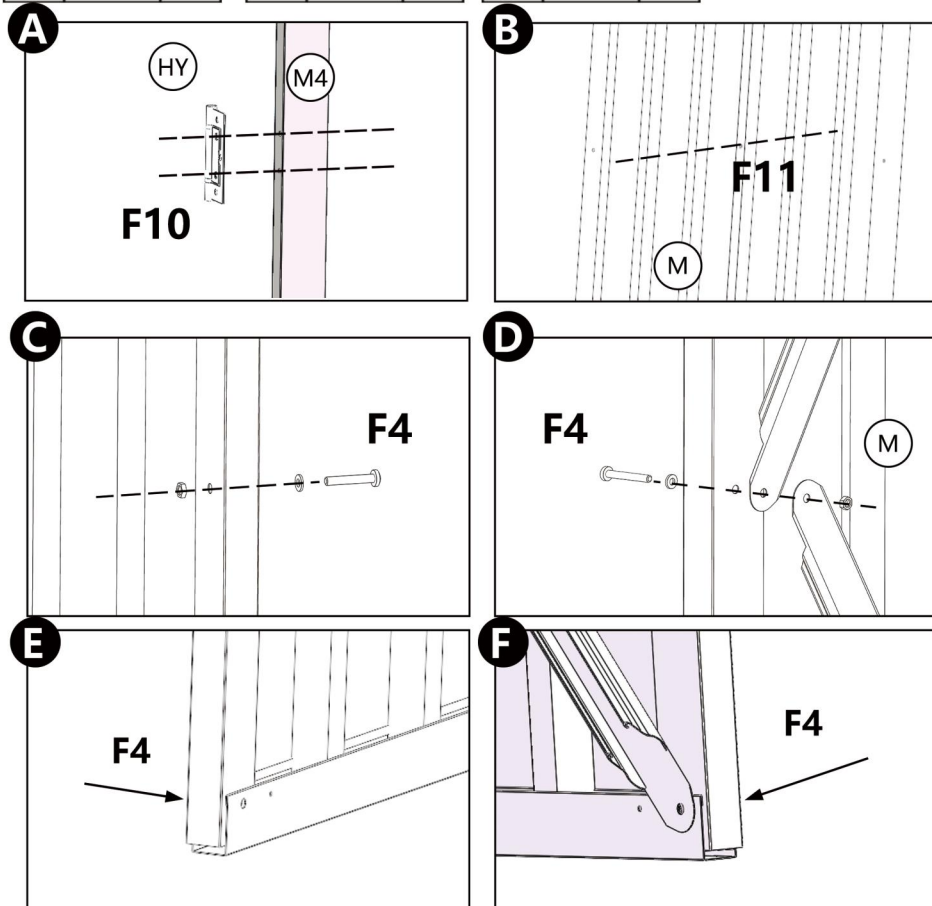

Special Note: Before installation, HY must be mounted on M4 and secured with F10. Each M4 must have two HY units installed, as shown in Figure A. (The M4 has no front or back.)

Then align the holes on two M units and secure them with F11, as shown in Figure B.

Mount the assembled unit from Figure A onto M, then install M2 at the top and bottom of M. → Install M4/M5L/M5R on the left and right sides of M. → Mount M3 inside M. Secure the center of the upper and lower M2 with screw F4, along with M4/M5L/M5R, as shown in Figures C and D.

E: Insert the F4 screw externally, simultaneously securing the M2 and M5R. For the other door, insert the F4 screw to secure the M2 and M5L, then position the CS internally and secure it from the inside using the F1 screw.

F: Secure M, M2 and M4 together from the front using F4.

(The side with more holes on the M5L and M5R should face the front.)

NO.	PART	Qty.
F1		4
CS		2

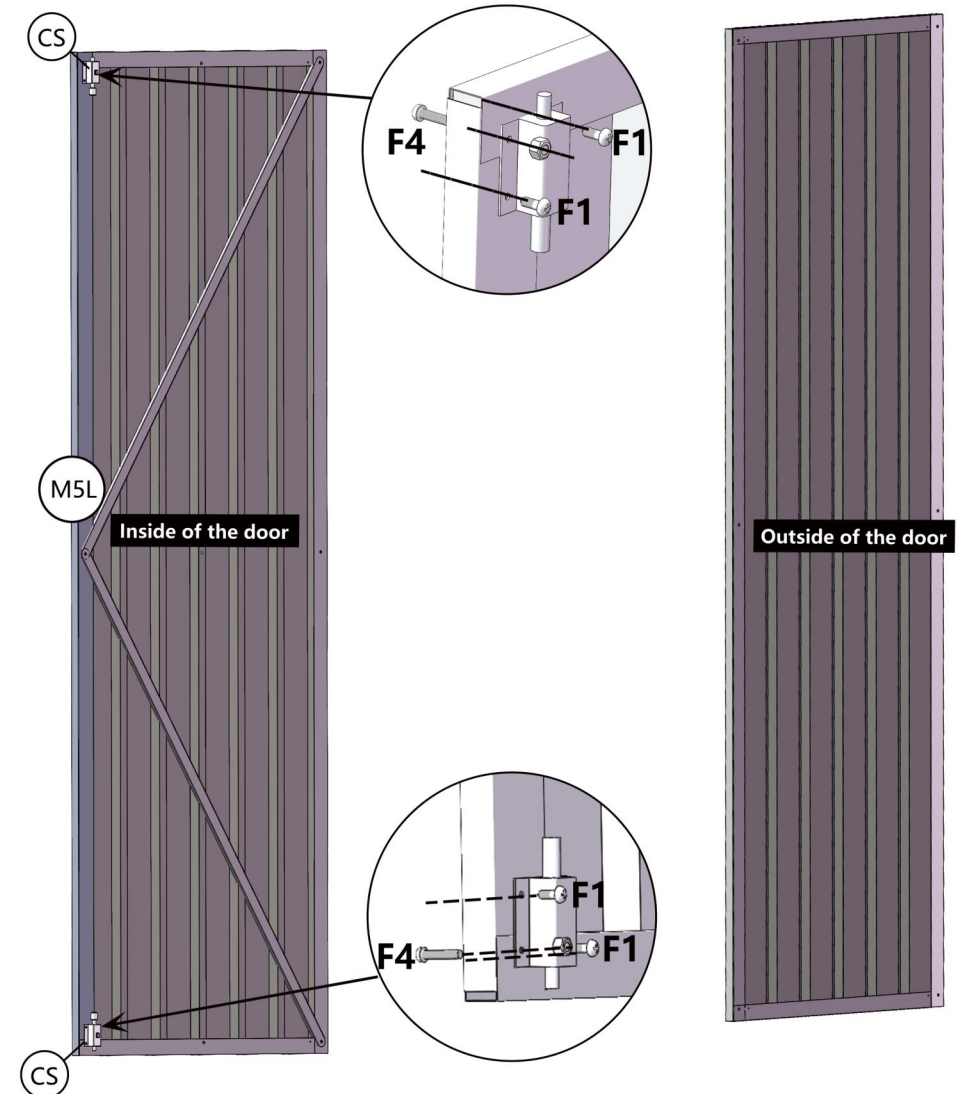

NO.	PART	Qty.
F10		12

The side with the M5L and M5R holes facing forward is for subsequent installation of the SK.

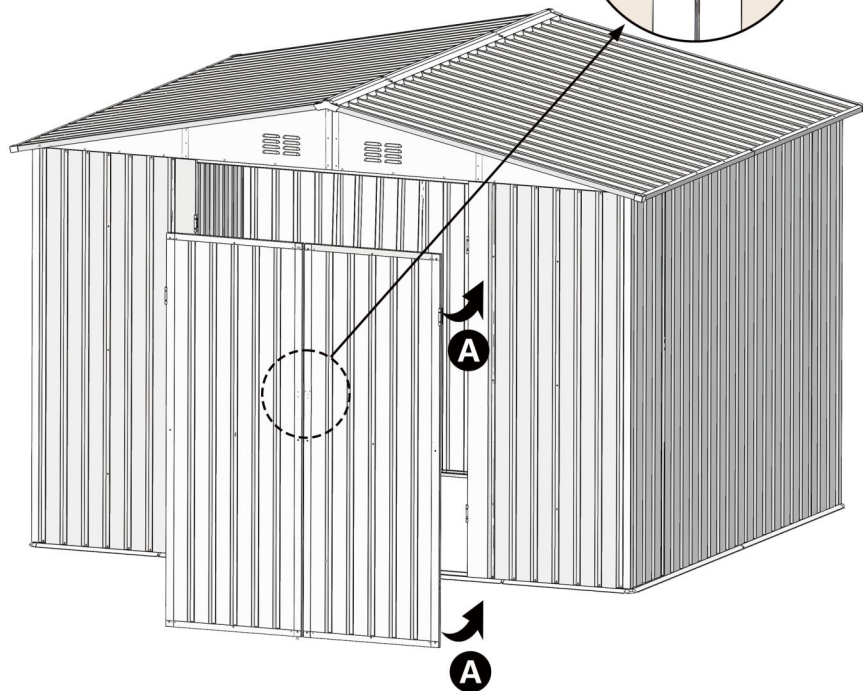
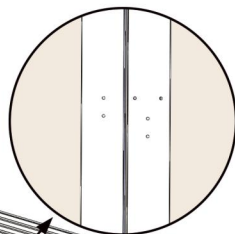

Notice:
Secure the installed door to the door frame with F10

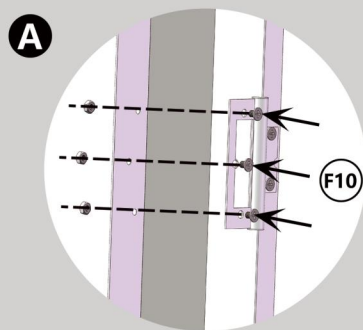

NO.	PART	Qty.
SK		1
F1		6

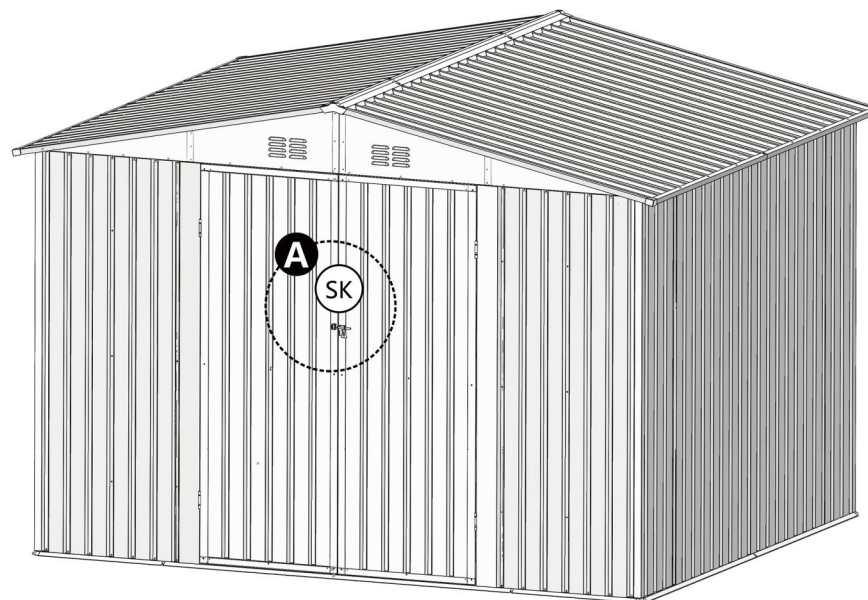

Notice:
Mount SK to the door (M5R/M5L), secure with F1, mount A1 on one side of the door, install the A2 section on the other side, as shown.

