

60051 DINING CHAIR ASSEMBLY INSTRUCTION

Thank you for purchasing this quality product. Be sure to check all packing material carefully for small parts which may have come loose inside the carton during shipment. Separate, identify and count all parts and hardware. Compare with the parts list to be sure all parts are present.

IMPORTANT : PLEASE READ INSTRUCTION BEFORE STARTING THE ASSEMBLY.

"DO NOT TIGHTEN SCREWS UNTIL COMPLETELY ASSEMBLED"

"DO NOT OVERTIGHT ANY HARDWARE"

WARNING : SMALL PARTS AND HARDWARE NOT FOR CHILDREN UNDER 3 YEARS. ADULT ASSEMBLY REQUIRED.

TABLE OF CONTENTS

HARDWARES LIST	PAGE 2
PARTS LIST	PAGE 3
PARTS' LOCATION	PAGE 4
ASSEMBLY STEPS	PAGE 5 - 6
ASSEMBLY COMPLETED	PAGE 6

ASSEMBLY TOOLS REQUIRED

1. Screwdriver (not provide)

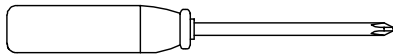

2. Hammer (not provide)

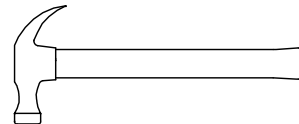



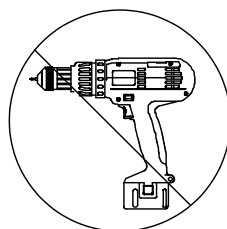

Skip the power drill this time.



60051 DINING CHAIR ASSEMBLY INSTRUCTION

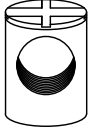

HARDWARES LIST

ITEM	DESCRIPTION	DRAWING	QTY
A	JCBC SCREW M6 x 60MM		20 PCS
B	WOOD DOWEL M8 x 30MM		28 PCS
C	CSK C/B SCREW (M4 x 32MM)		6 PCS
D	BARREL NUT		20 PCS
E	M4 ALLEN KEY (100MM)		1 PC

There are total TWO (2) packs of hardware packs.
Each hardware pack includes the hardware for TWO (2) chairs.

60051 DINING CHAIR ASSEMBLY INSTRUCTION

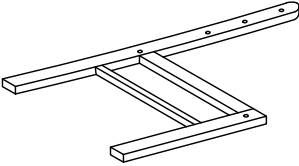
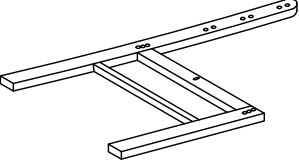
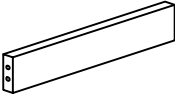
PARTS LIST

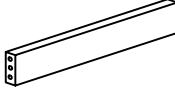
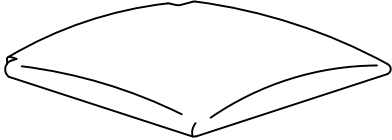
ITEM	DESCRIPTION	DRAWING	QTY
1	LEG (LEFT) WITH LABEL "L"		4 PCS
2	LEG (RIGHT) WITH LABEL "R"		4 PCS
3	CHAIR HEAD		12 PCS
4	BACK RAIL WITH LABEL "4"		4 PCS
5	FRONT RAIL WITH LABEL "5"		4 PCS
6	SEAT		4 PCS

60051 DINING CHAIR ASSEMBLY INSTRUCTION

PARTS ' LOCATION

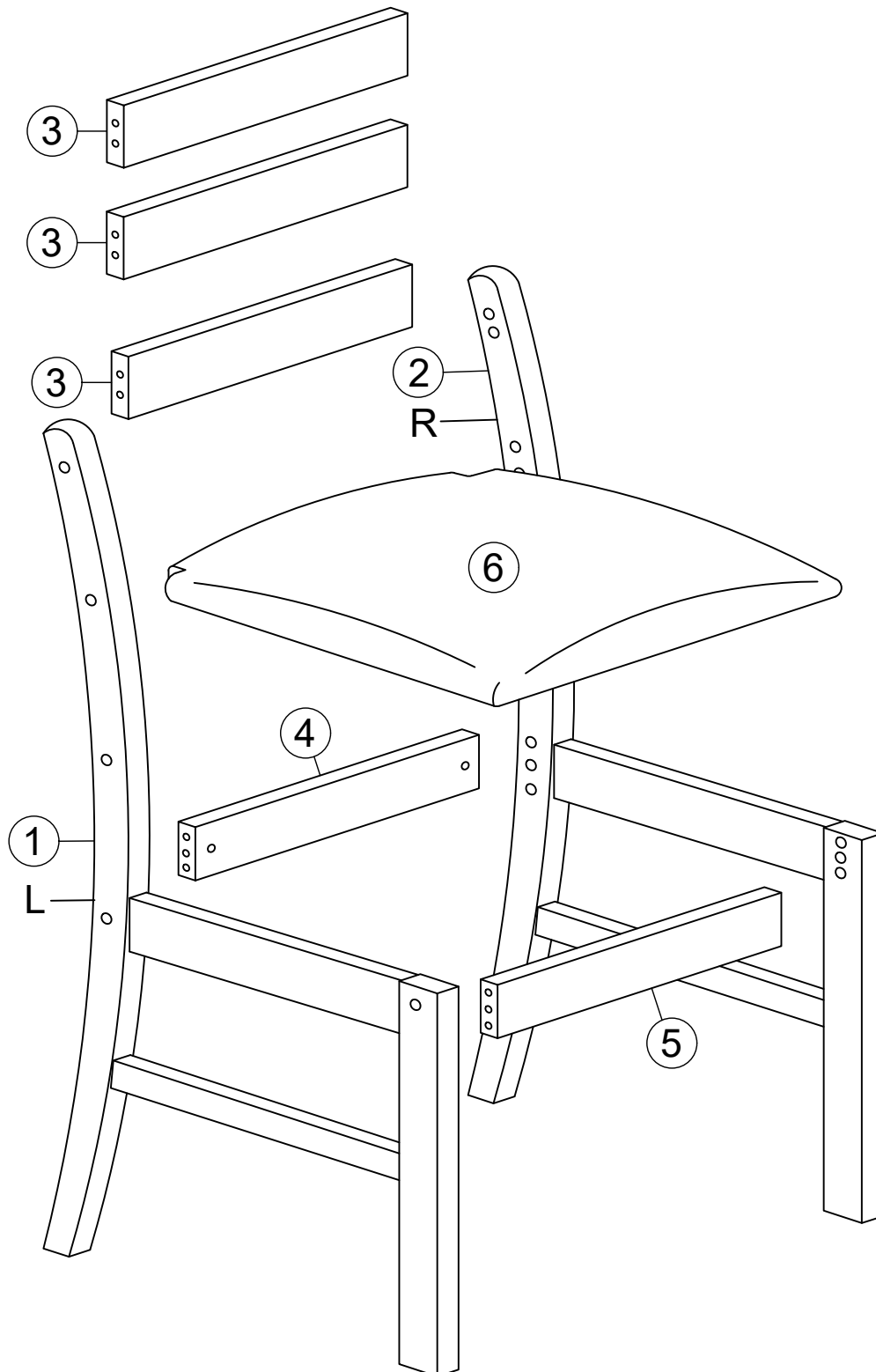

60051 DINING CHAIR ASSEMBLY INSTRUCTION

STEP 3

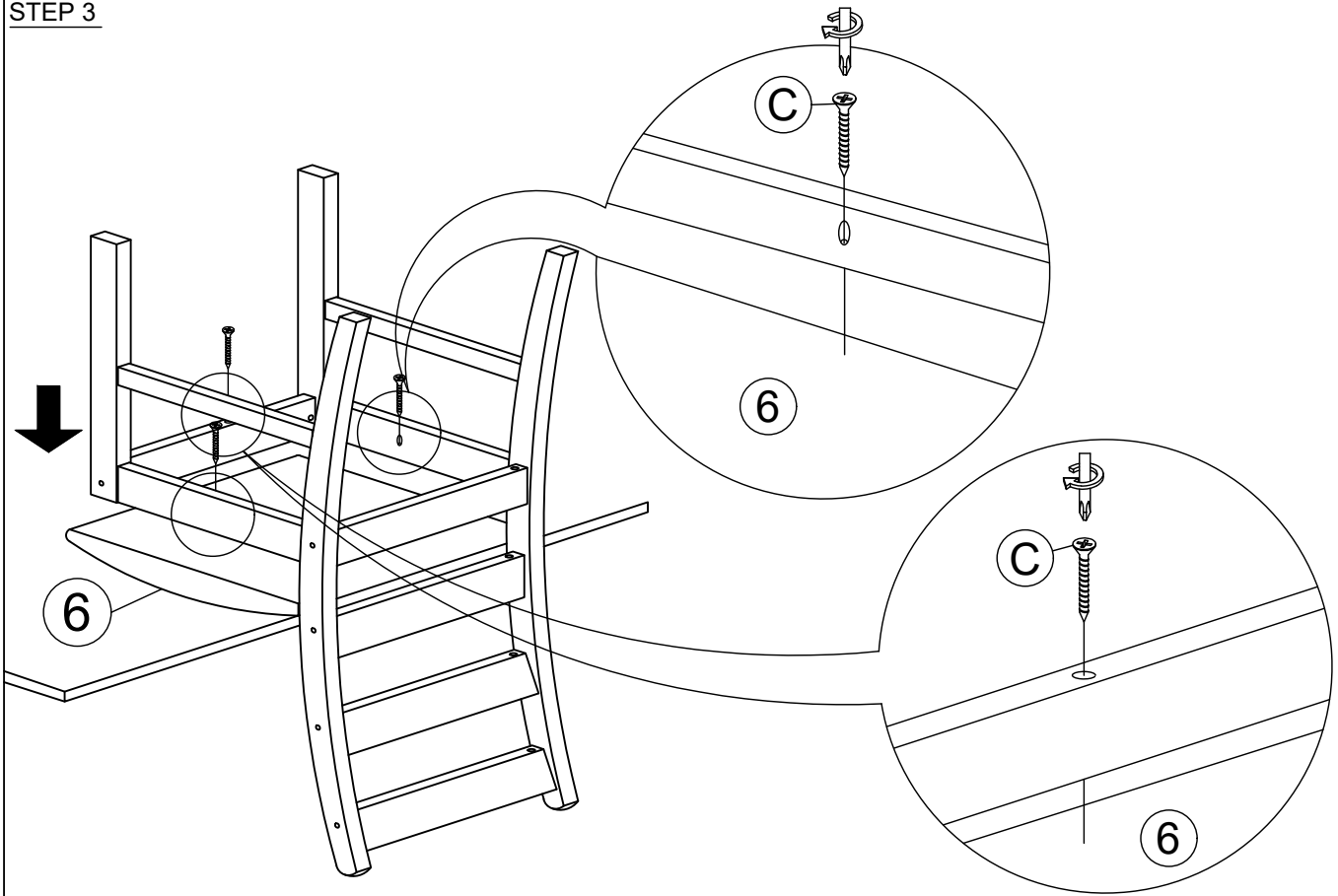

STEP 4

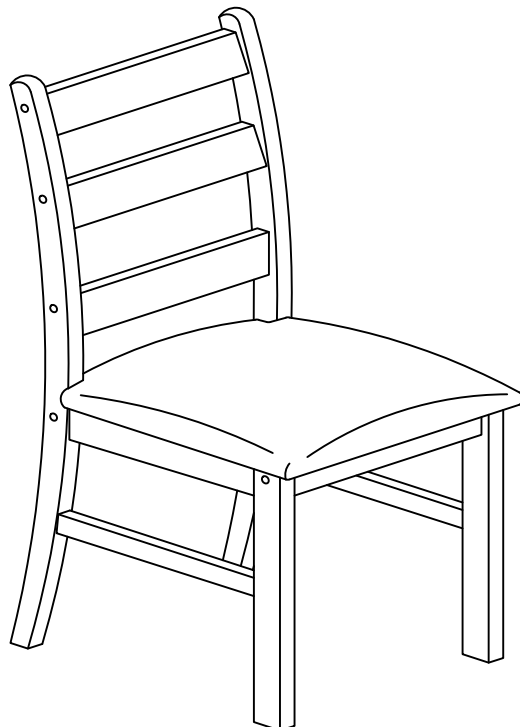

ASSEMBLY
COMPLETED