

C-Shape Side End Table Furniture Assembly Instructions

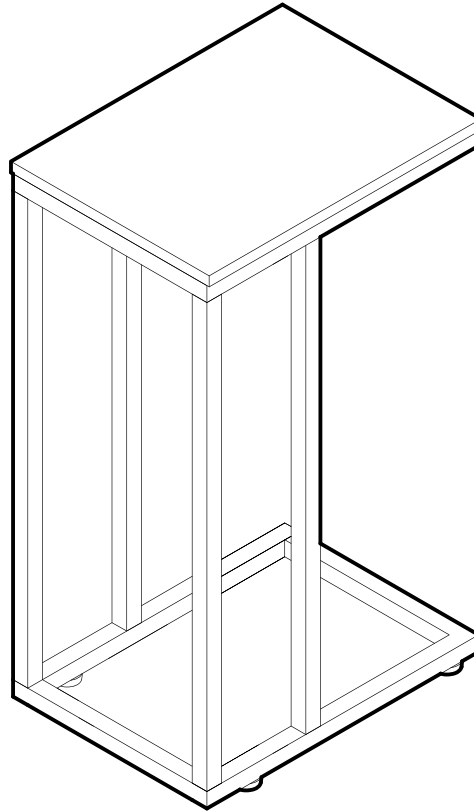

Universe Home Inc.

If you have any issues with the product,
please contact us.

☎ : +1 (877) 313 6212
(Mon–Fri, 8:00 am – 5:00 pm PT)

@ : info@universeh.com (24/7)

🌐 : unipawspro.com



Scan to submit a request
We'll reply within 1 business day

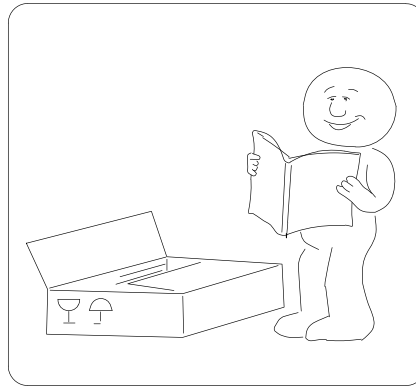
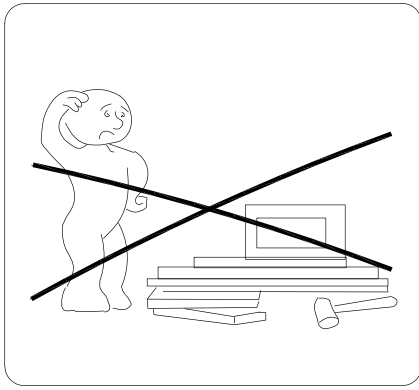

! WARNING !

1. PLEASE READ ALL INSTRUCTIONS CAREFULLY BEFORE STARTING ASSEMBLY.
2. DO NOT LET ANY SHARP OBJECTS TOUCH OR RUB THE SURFACE OF THE PRODUCT.
3. WHEN ASSEMBLING, DO NOT LET CHILDREN PLAY AROUND THE WORKING AREA.
4. PLEASE CONFIRM ALL PARTS ARE CORRECT BEFORE STARTING THE ASSEMBLY PROCESS.
5. DO NOT TIGHTEN ALL BOLTS AND SCREWS COMPLETELY UNTIL THE ENTIRE UNIT HAS BEEN ASSEMBLED AND SET UP.

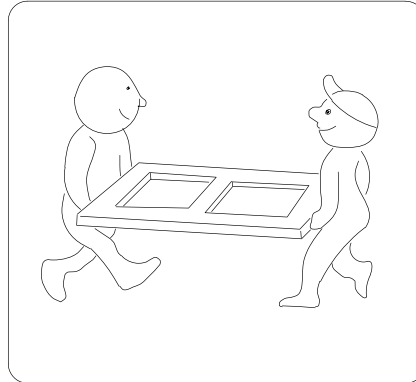
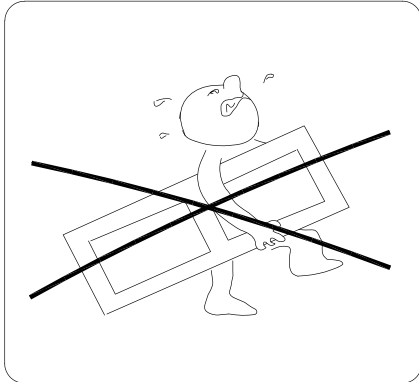
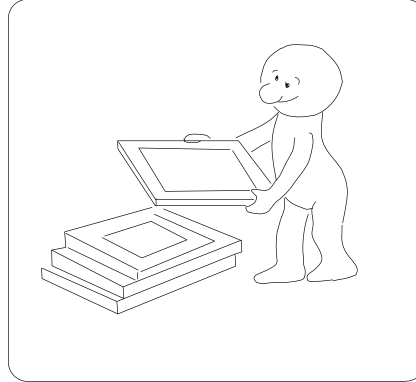
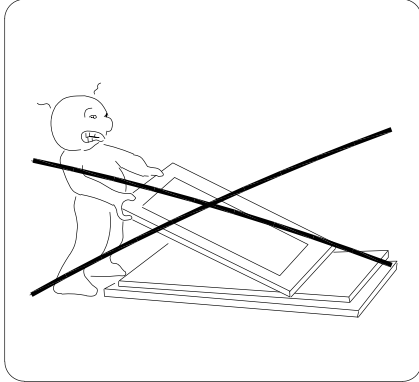

ADVISE

1. DO NOT SIT OR STAND ON THIS PRODUCT. IT IS INTENDED FOR PETS ONLY.
2. THIS PRODUCT SHOULD BE ASSEMBLED BY AN ADULT.
3. PLEASE PUT THE PRODUCT ON A SMOOTH SURFACE AFTER YOU ASSEMBLED IT.
4. PLACE ALL PARTS ON A CLEAN AND SMOOTH SURFACE SUCH AS A RUG OR CARPET TO AVOID THE PARTS FROM BEING SCRATCHED.
5. THE SCREW OF HINGE ON THE DOOR ALSO CAN BE ADJUSTABLE, TO MAKE IT EVEN THEN TIGHTEN ALL SCREWS.

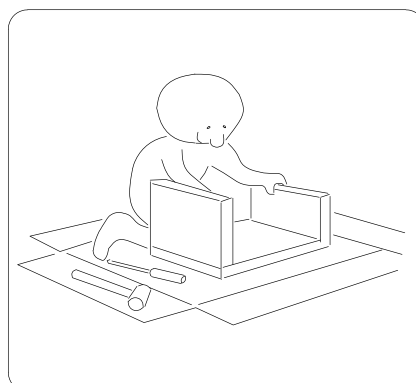
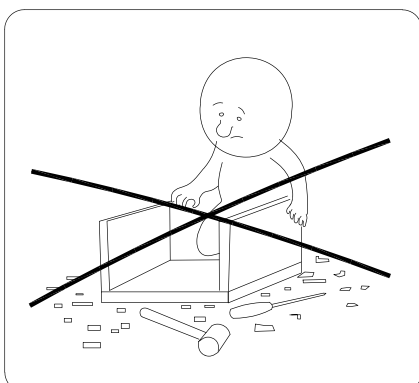
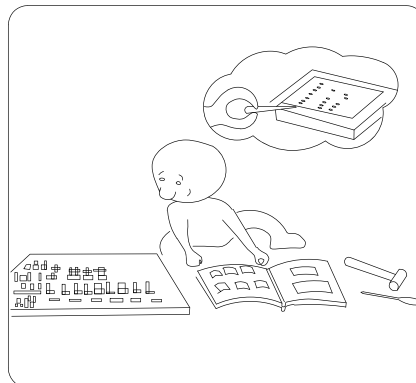
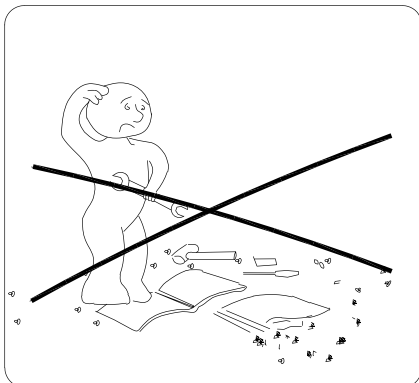

PARTS

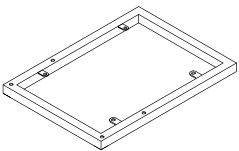
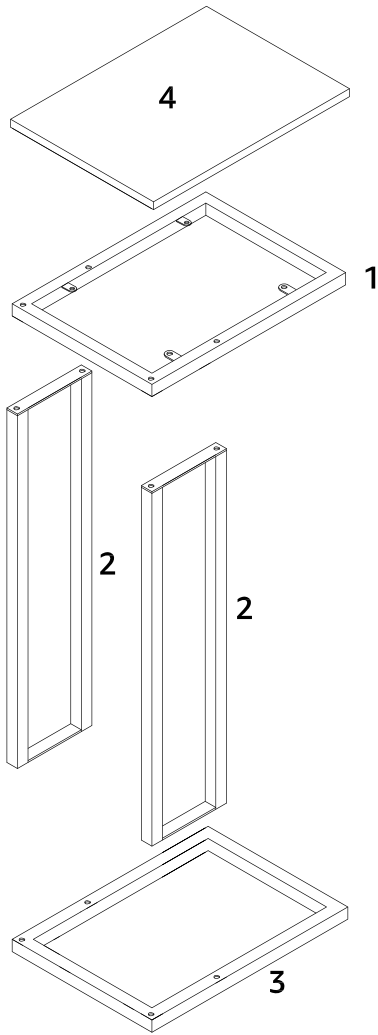

1
Top Frame
x1

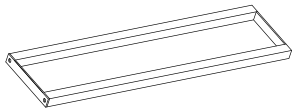

2
Leg
x2

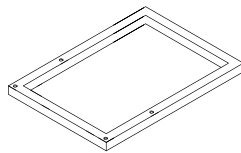

3
Bottom Frame
x1

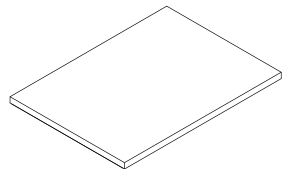

4
Top Panel
x1

HARDWARE



A
x 4 pcs



B
x 8 pcs





C
x 4 pcs



D
x 1 pc

ASSEMBLY INSTRUCTIONS

- 1 Connect leg 2 and top frame 1 with bolt B using Allen Wrench D.
Connect leg 2 and bottom frame 3 with bolt B using Allen Wrench D.
Install the top panel 4 to top frame 1 with bolt A using Allen Wrench D.

		
A x 4 pcs	B x 8 pcs	D x 1 pc

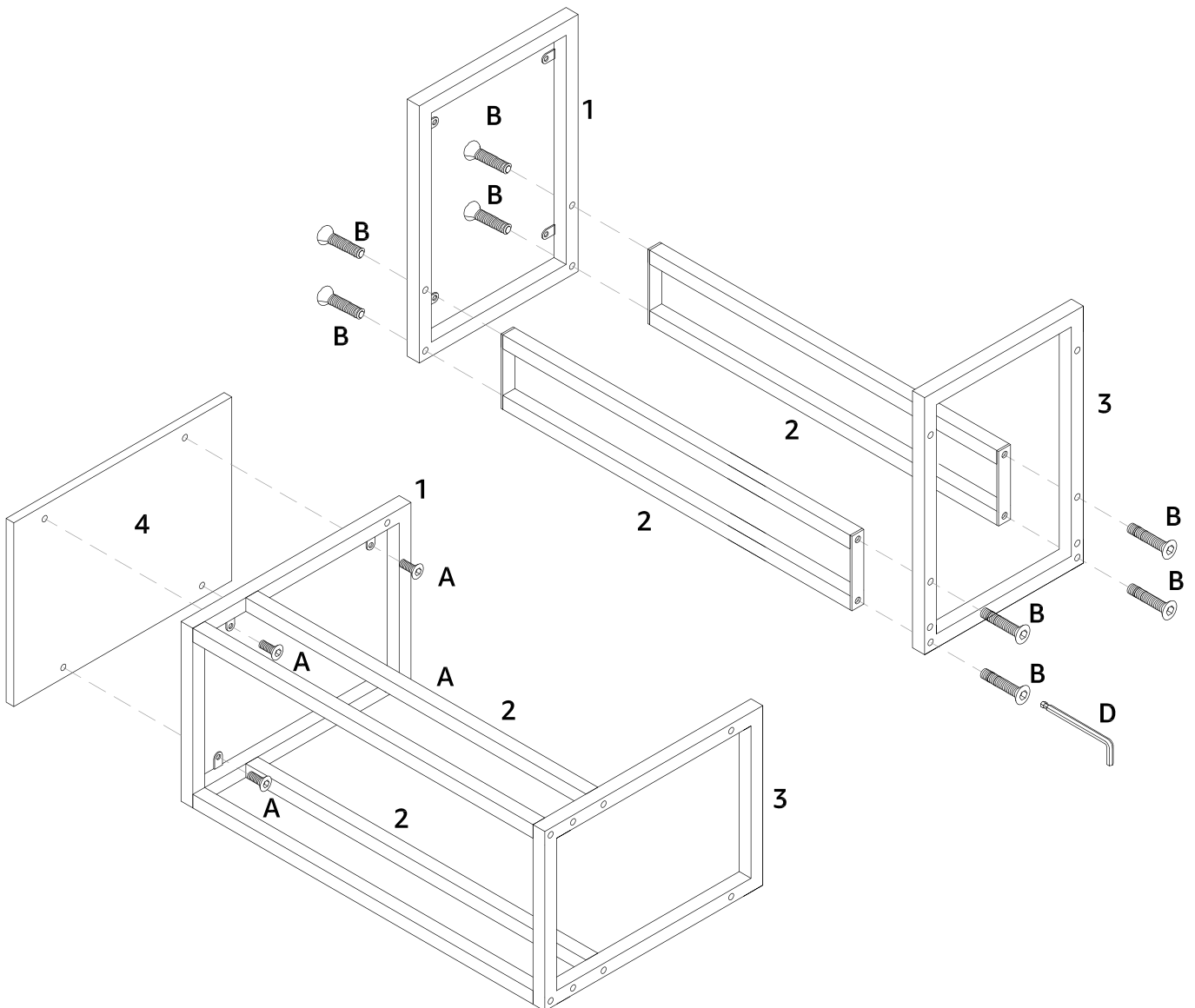

2 Tighten the adjustable leg C to bottom frame 3.

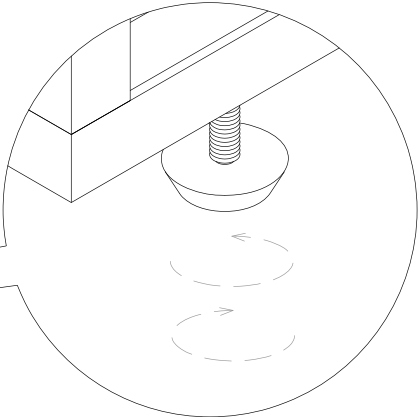
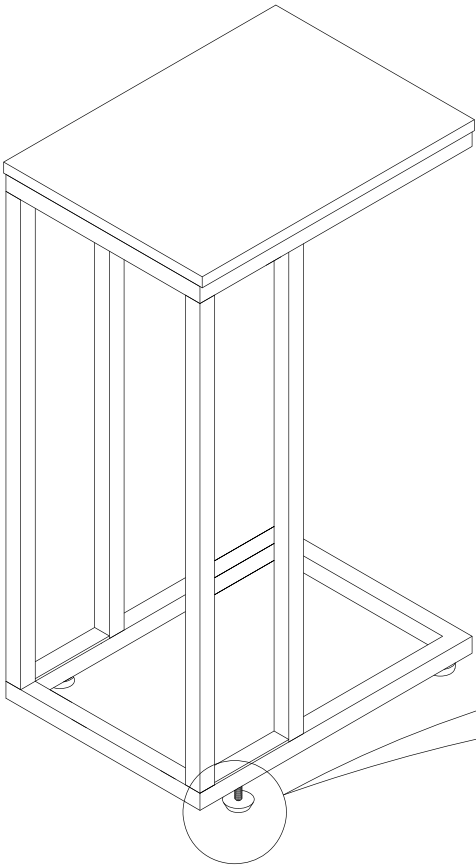
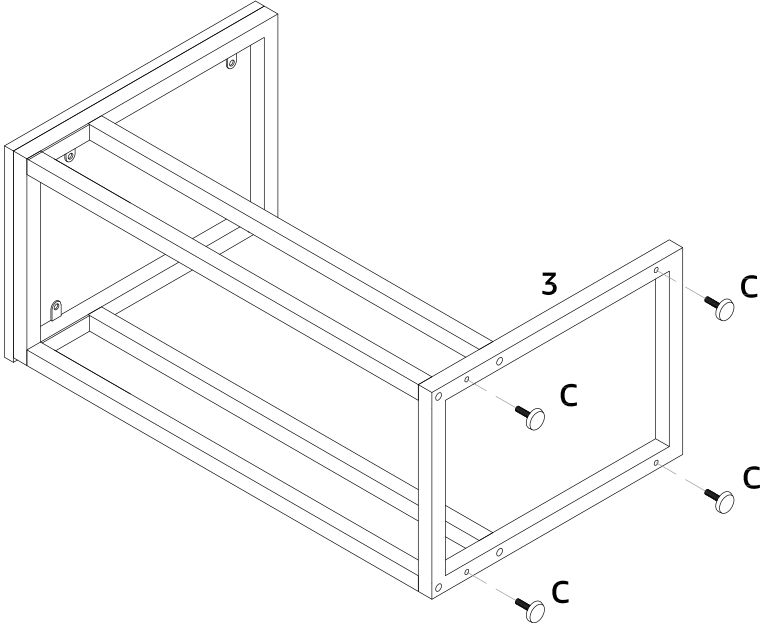
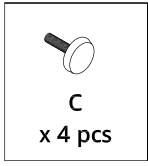

! NOTE: Please do the following if the unit is not level.