









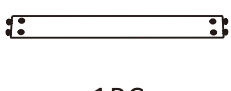

# Accent Chair Assembly Instructions

Your accent chair comes packaged in one box.

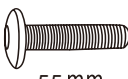
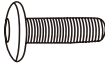
DO NOT use any sharp objects to open plastic wrapped components as damage to product or components may result.

Carefully remove all of the components from the packaging and set aside for assembly. Assemble on a soft surface to prevent scratching the finish.

<p>A</p>  <p>back</p> <p>1PC</p>	<p>B</p>  <p>seat</p> <p>1PC</p>	<p>C</p>  <p>1PC</p>	<p>D</p>  <p>1PC</p>	<p>E</p>  <p>1PC</p>	<p>F</p>  <p>8PCS</p>
<p>G</p>  <p>55mm</p> <p>8PCS</p>	<p>H</p>  <p>30mm</p> <p>2PCS</p>	<p>I</p>  <p>2PCS</p>	<p>J</p> 	<p>K</p>  <p>1PC</p>	

**Step 1**

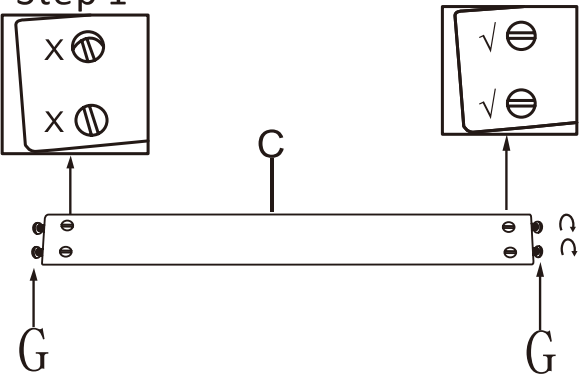

Step 1: Unscrew the 2 bolts at two ends of "C" before assembly, and make sure the groove on nut "j" at horizontal position, or the bolts can not be assembled.

**Step 2**

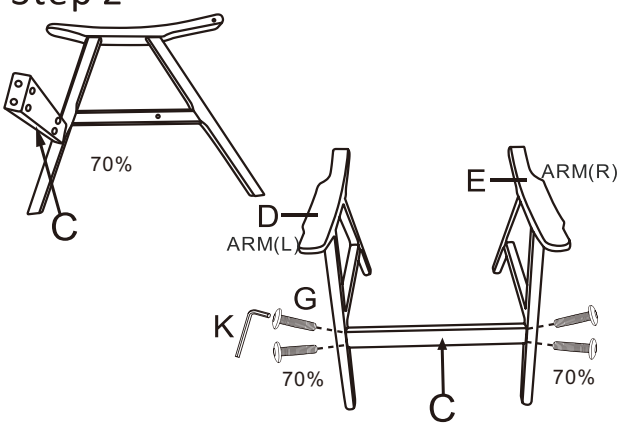

Step 2: Please screw C/D/E to 70% to hold the parts together, do not fully tighten!

**Step 3**

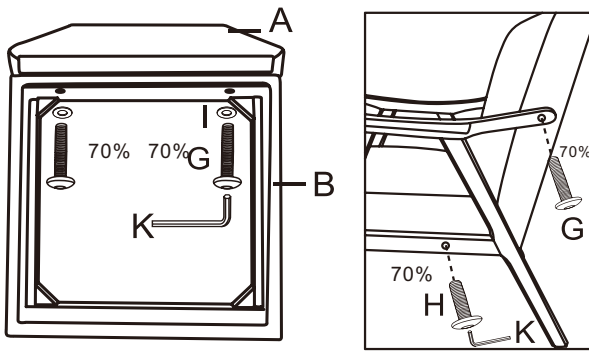

Step 3: Screw seat base B with back A at 70% then put them on the wood frames, screw the bolts on the sides around 70% to hold them together. When screw the last bolt, it may need to pull the frame a little bit to make sure the last bolt match the hole.

**Step 4**

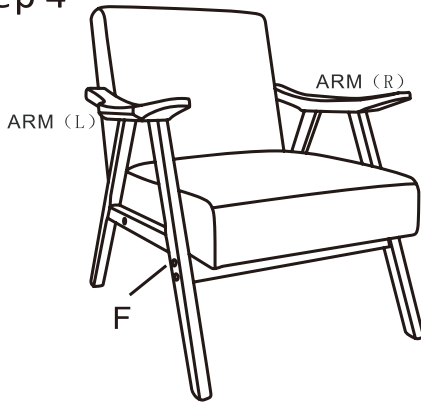

Step 4: After finish all above steps, go back and tighten all the screws 100%.

Your accent chair style may differ from images. Care for your furniture by periodically tightening all legs. Fabric will fade or discolor in direct sunlight. Minimize exposure to direct sunlight to extend the life of your furniture.