

# ASSEMBLY INSTRUCTION

SKU CODE: WF291755 / WF291756

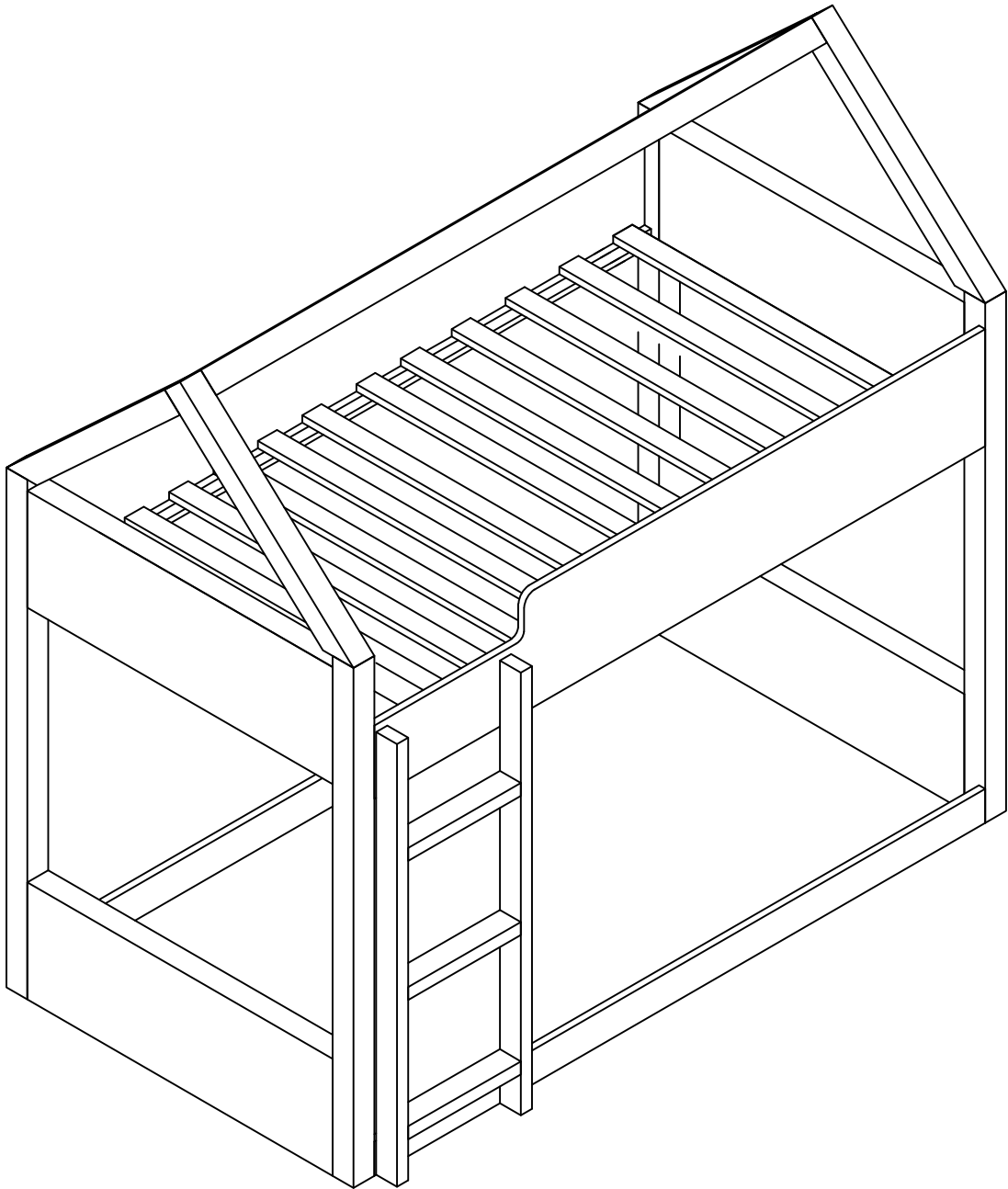

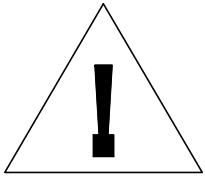

# SAFETY WARNINGS

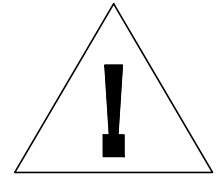

1. This bed is designed for use only mattress(es) meeting the following specifications on the upper bunk:  
Upper *bunk* (*bunk bed and tribed included*)

<b>Bed Type</b>	<b>Length</b>	<b>Width</b>	<b>Thickness</b>
<b><i>Twin Standard</i></b>	<b><i>74"-75"</i></b>	<b><i>37 ½"-38 ½"</i></b>	<b><i>6"max</i></b>

2. Replacement parts, including additional guardrails, maybe obtained from any of our (GIGACLOUD TECHNOLOGY (USA) INC. 18961 ARENTH AVENUE CITY OF INDUSTRY, CA, 91748) dealers.
3. Follow the information on the warnings appearing on the upper bunk bed end structure and on the carton. Do not remove warning label from bed.
4. Always use the recommended size mattresses or mattress supports, or both, to help prevent the likelihood of entrapment or falls.
5. Surface of the mattress must be at least 5" . (127 mm) below the upper edge of guardrails.
6. Do not allow children under 6 years of age to use the upper bunk.
7. Periodically check and ensure that the guardrail, ladder, and other components are in their proper position, free from damage, and that all connectors are tight.
8. Do not allow horseplay on or under the bed and prohibit jumping on the bed.
9. Always use the ladder for entering and leaving the upper bunk.
10. Do not use substitute parts. Contact the manufacturer or dealer for replacement parts.
11. Use of a night light may provided added safety precaution for a child using the upper bunk.
12. Always use guardrails on both long sides of the upper bunk. If the bunk bed will be placed next to the wall, the guardrail that runs the full length of the bed should be placed against the wall to prevent entrapment between the bed and wall.
13. The use of water or sleep flotation mattresses is prohibited.
14. STRANGULATION HAZARD - Never attach or hang items to any part of the bunk bed that are not designed for use with the bed; for example, but not limited to, hook, belts and jump ropes.
15. Keep these instructions for future reference.
16. Prohibit more than one person on upper bunk.
17. We recommend assembling your bunk bed on the shipping carton to protect your floor or carpet.
18. Be certain all staples are out of the box before beginning assembly on the shipping carton.

# Detail View - BUNK BED

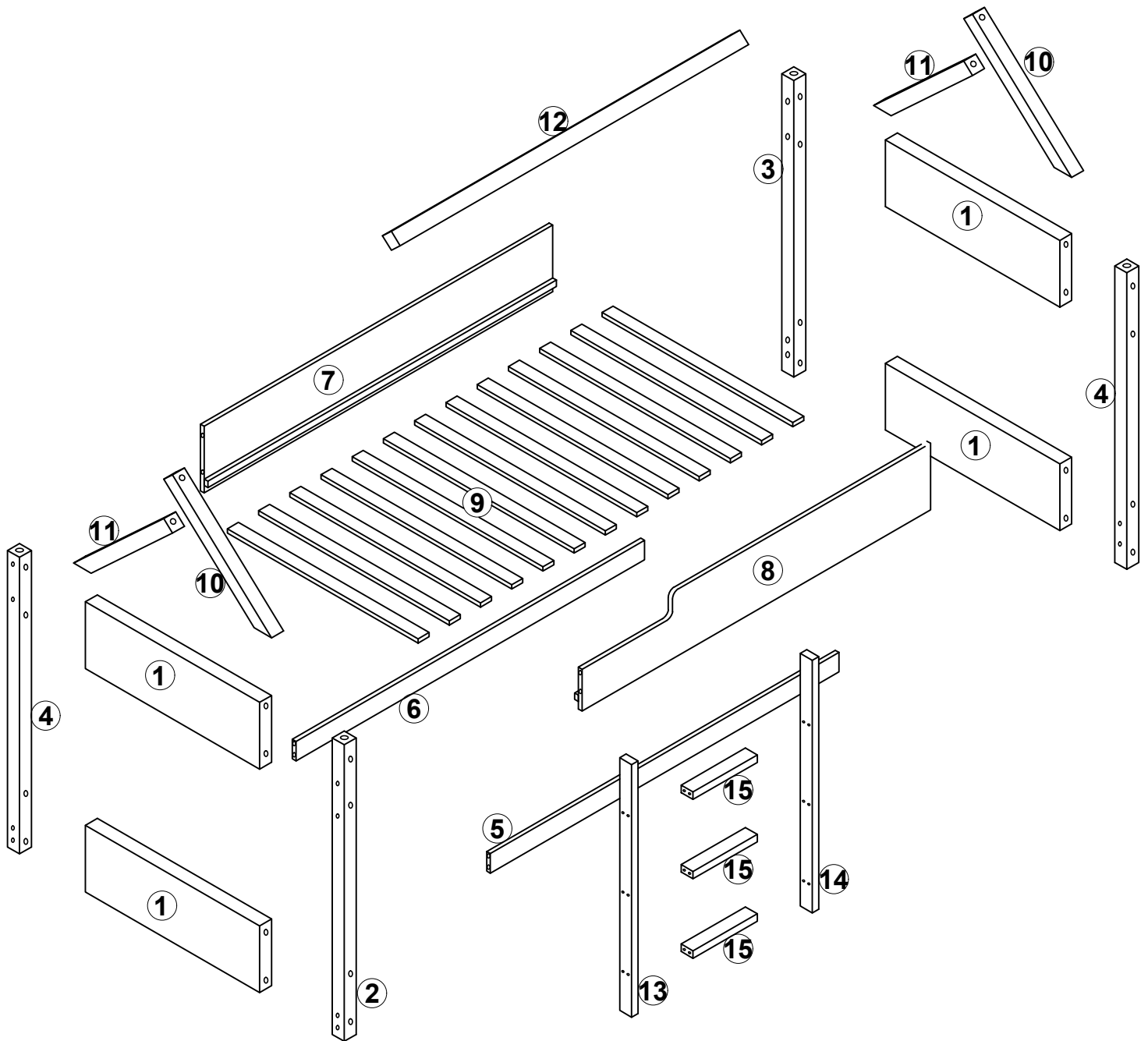

Identifying the Hardware - Identify the hardware using the illustrations below.

Part Lists: **WF291755**

1

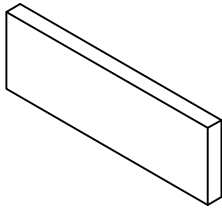



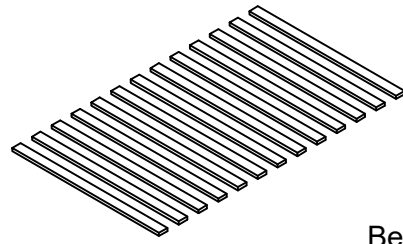

Headboard-4pcs

9



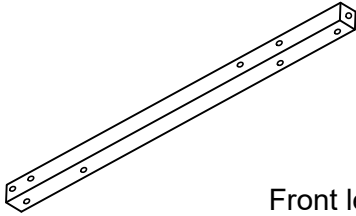
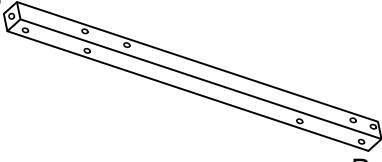
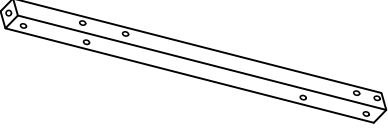
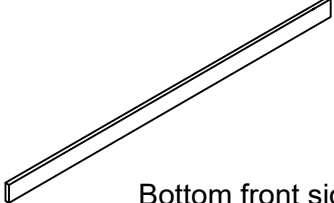
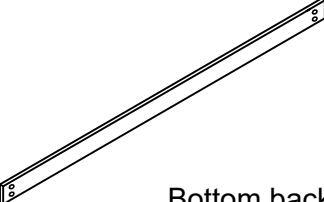
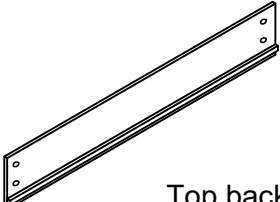
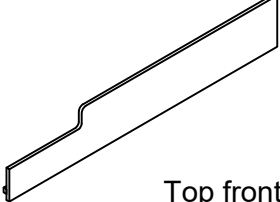
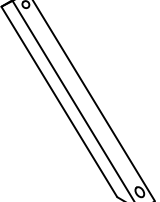

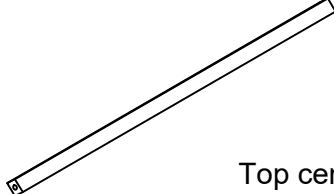

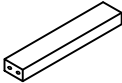

Bed slat -13pcs

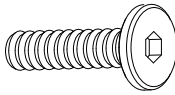
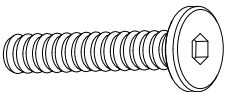
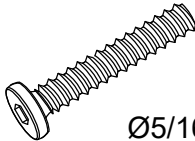
Part Lists: **WF291756**

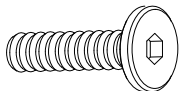
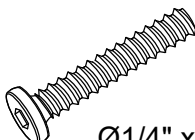
<p><b>2</b></p>  <p>Front left leg-1pc</p>	<p><b>3</b></p>  <p>Back right leg -1pc</p>
<p><b>4</b></p>  <p>Front right &amp; back left leg-2pcs</p>	<p><b>5</b></p>  <p>Bottom front side rail - 1pc</p>
<p><b>6</b></p>  <p>Bottom back side rail - 1pc</p>	<p><b>7</b></p>  <p>Top back side rail -1pc</p>
<p><b>9</b></p>  <p>Top front side rail -1pc</p>	<p><b>10</b></p>  <p>Top front rail -2pcs</p>
<p><b>11</b></p>  <p>Top back rail -2pcs</p>	<p><b>12</b></p>  <p>Top center rail -1pc</p>
<p><b>13</b></p>  <p>Ladder left -1pc</p>	<p><b>14</b></p>  <p>Ladder right -1pc</p>
<p><b>15</b></p>  <p>Ladder step -3pcs</p>	

# HARDWARE LISTS: WF291756

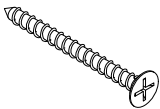
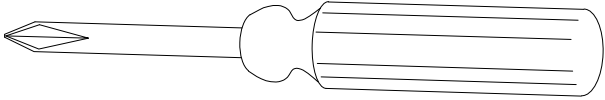
<p><b>A</b></p>  <p>4mm Allen key (1pc)</p>	<p><b>B</b></p>  <p>Ø5/16" x 90mm Hex-head bolt (16pcs)</p>
<p><b>C</b></p>  <p>Ø5/16" x 70mm Hex-head bolt (4pcs)</p>	<p><b>D</b></p>  <p>Ø5/16" x 50mm Hex-head bolt (10pcs)</p>
<p><b>E</b></p>  <p>Ø5/16" Spring washer (30pcs)</p>	<p><b>F</b></p>  <p>Ø5/16" Flat washer(30pcs)</p>
<p><b>G</b></p>  <p>Ø1/4" x 40mm Hex-head bolt (4pcs)</p>	<p><b>H</b></p>  <p>Ø1/4" x 90mm Hex-head bolt (16pcs)</p>
<p><b>I</b></p>  <p>Ø1/4" Barrel nut (16pcs)</p>	<p><b>J</b></p>  <p>Ø1/4" Spring washer (20pcs)</p>
<p><b>K</b></p>  <p>Ø1/4" Flat washer(20pcs)</p>	<p><b>L</b></p>  <p>Ø4 x 30mm Wood screw (26pcs)</p>
 <p style="text-align: center;"><b>ASSEMBLY TOOLS REQUIRED ( NOT INCLUDED )</b></p>	



Read this instruction carefully. See hardware and furniture part list for guidance. Be sure all parts are complete, before you assemble. Place all wooden furniture parts on a clean and flat soft surface to prevent from being scratched. Follow the figure to start assembling.

**CAUTIONS :**

1. Do not FULLY - TIGHTEN the nut or nut bolt until all nut or bolt is ready assembled.
2. Do not OVER - TIGHTEN the nut or bolt to avoid causing damages to the thread.
3. Keep all hardware parts out of reach of children.

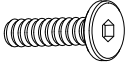

**NOTE : THE LIST AND QUANTITY SHOWN ARE FOR 1 UNIT ASSEMBLY.**

# STEP 1

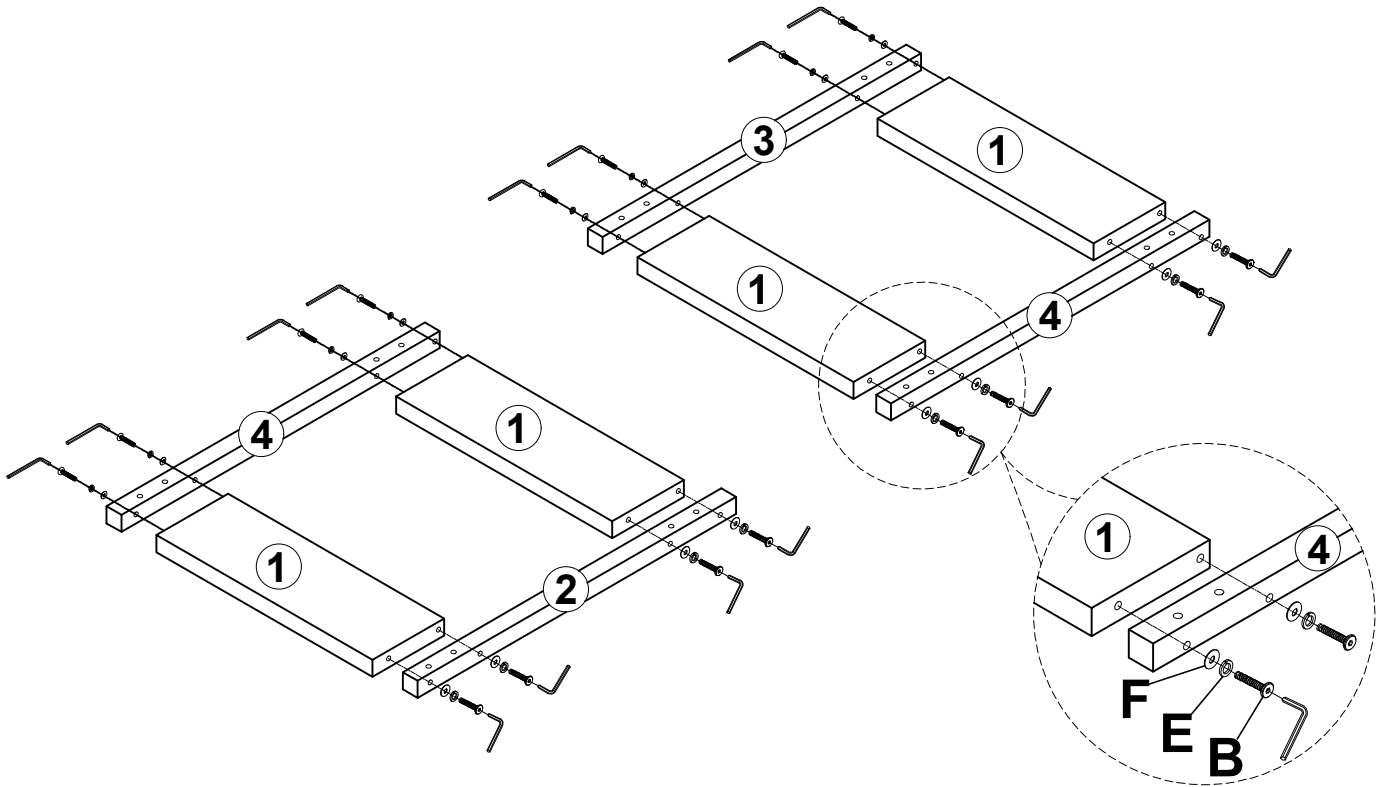
<b>E</b>		<b>F</b>		<b>B</b>	
<b>16PCS</b>		<b>16PCS</b>		<b>16PCS</b>	



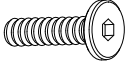

# STEP 2

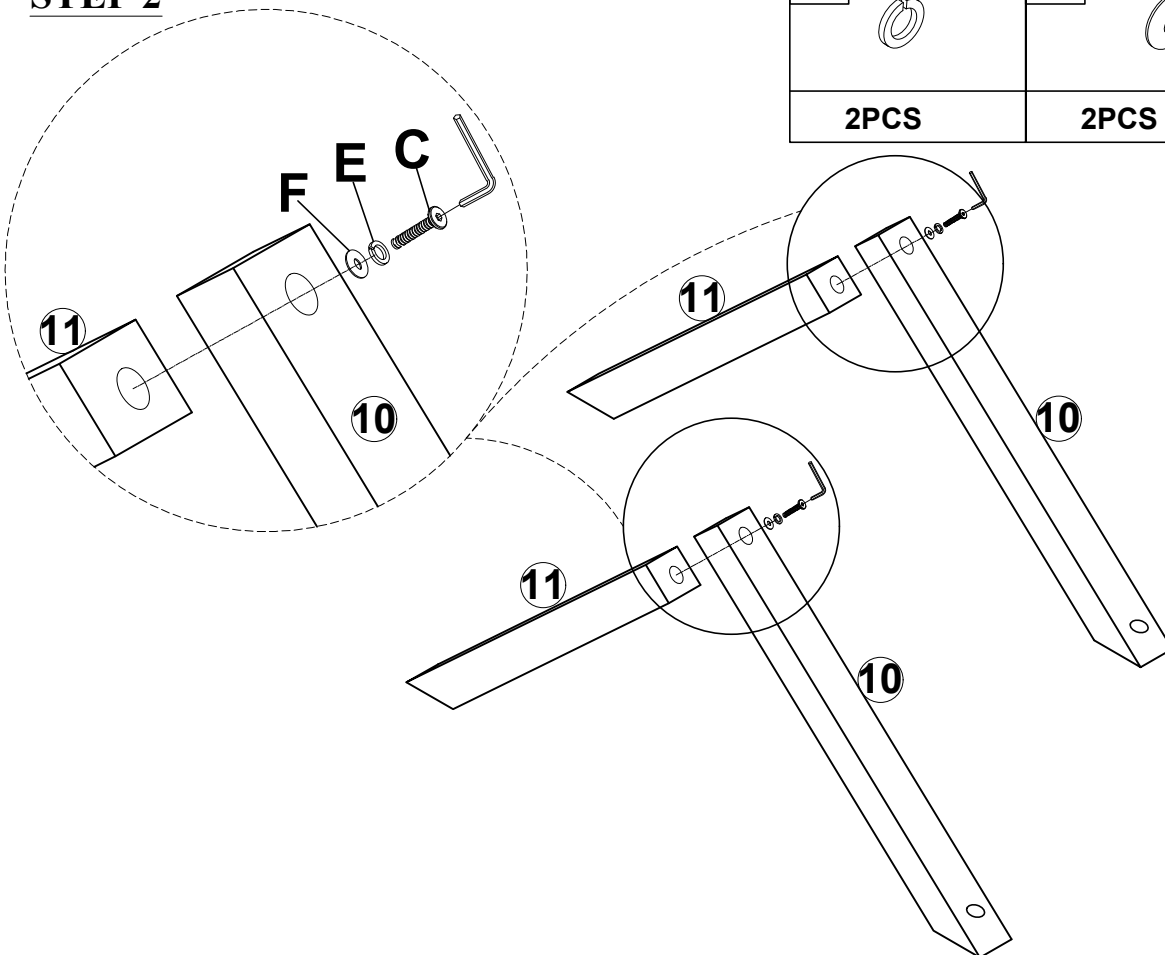
<b>E</b>		<b>F</b>		<b>C</b>	
<b>2PCS</b>		<b>2PCS</b>		<b>2PCS</b>	



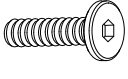

# STEP 3

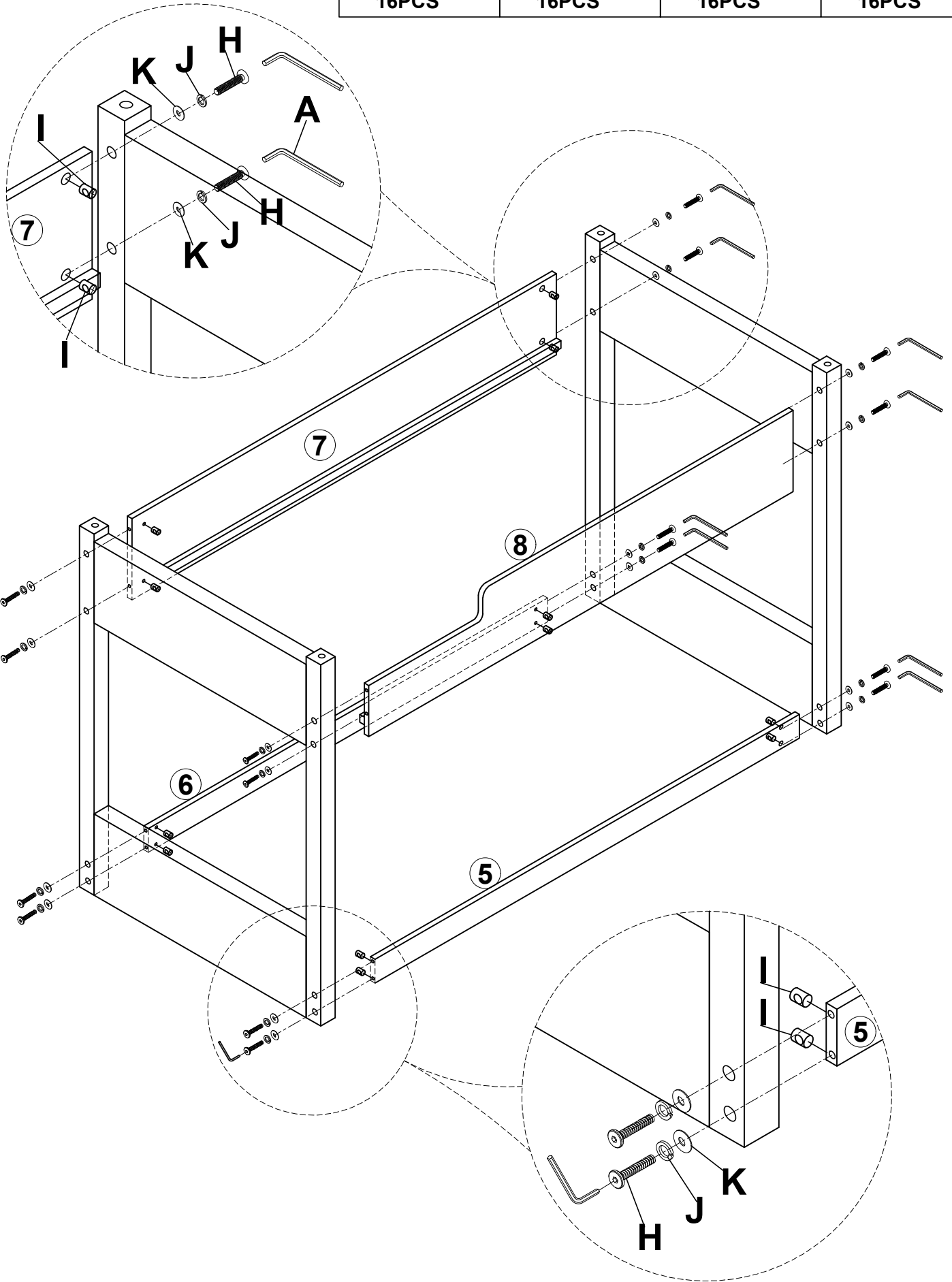
<b>I</b> 	<b>J</b> 	<b>K</b> 	<b>H</b> 
<b>16PCS</b>	<b>16PCS</b>	<b>16PCS</b>	<b>16PCS</b>



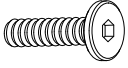

# STEP 4

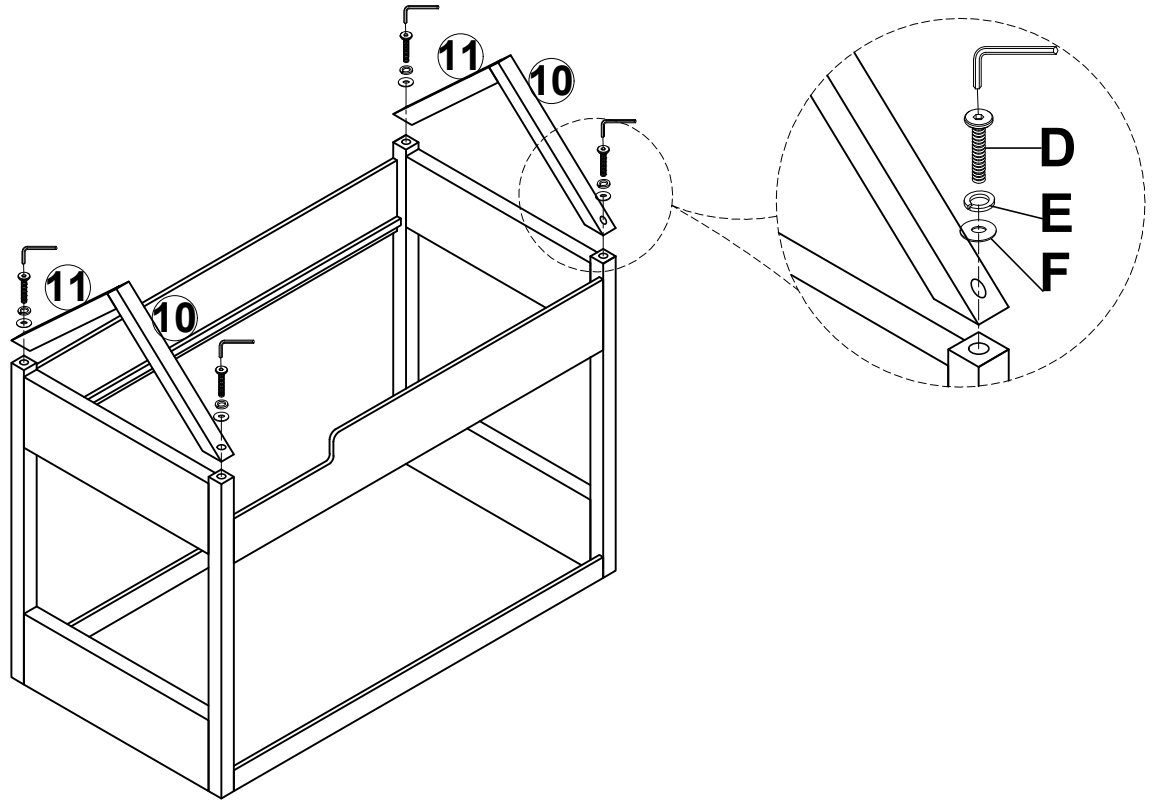
<b>E</b> 	<b>F</b> 	<b>D</b> 
<b>4PCS</b>	<b>4PCS</b>	<b>4PCS</b>



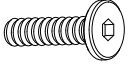

# STEP 5

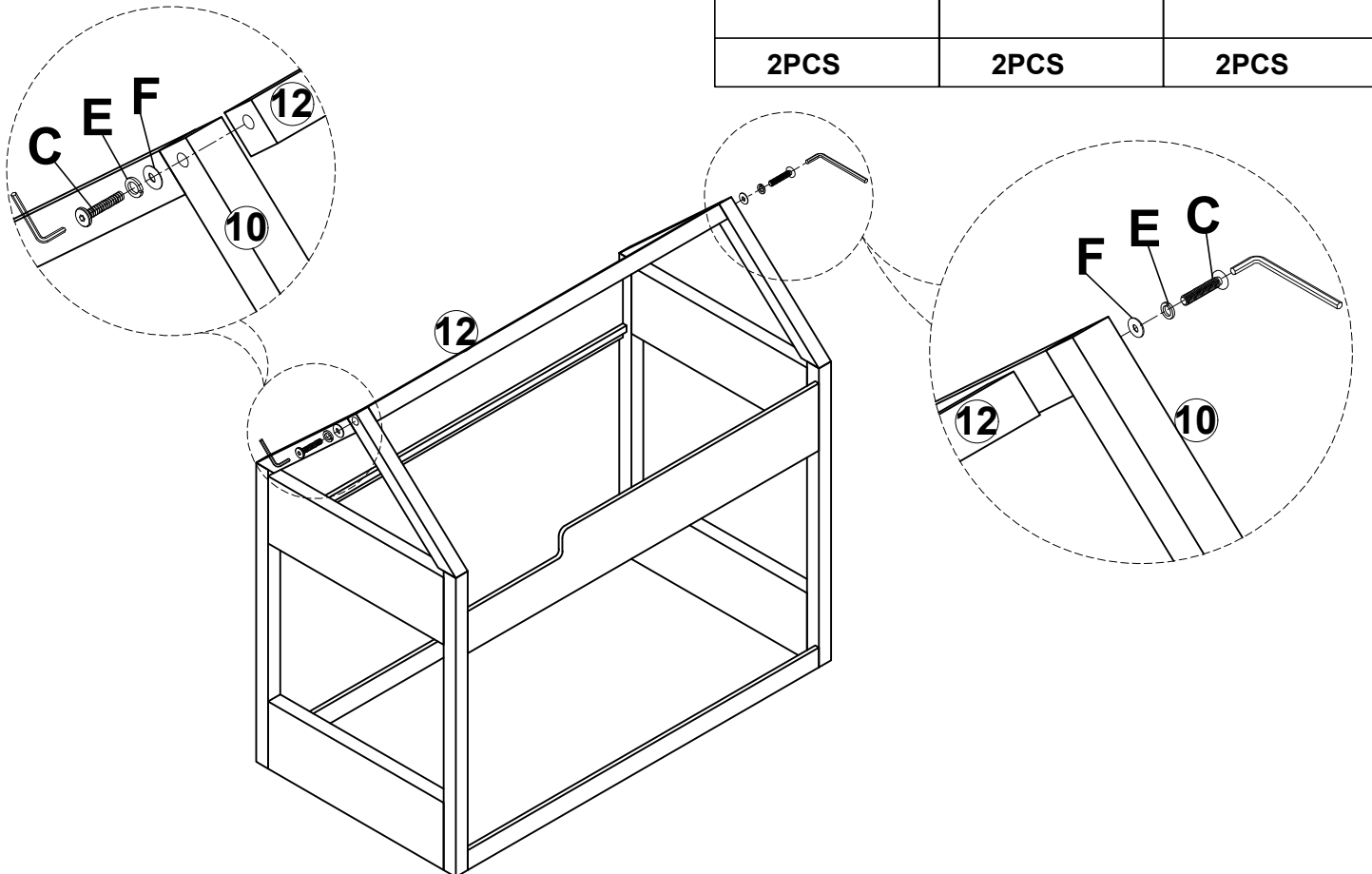
<b>E</b> 	<b>F</b> 	<b>C</b> 
<b>2PCS</b>	<b>2PCS</b>	<b>2PCS</b>



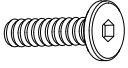

# STEP 6

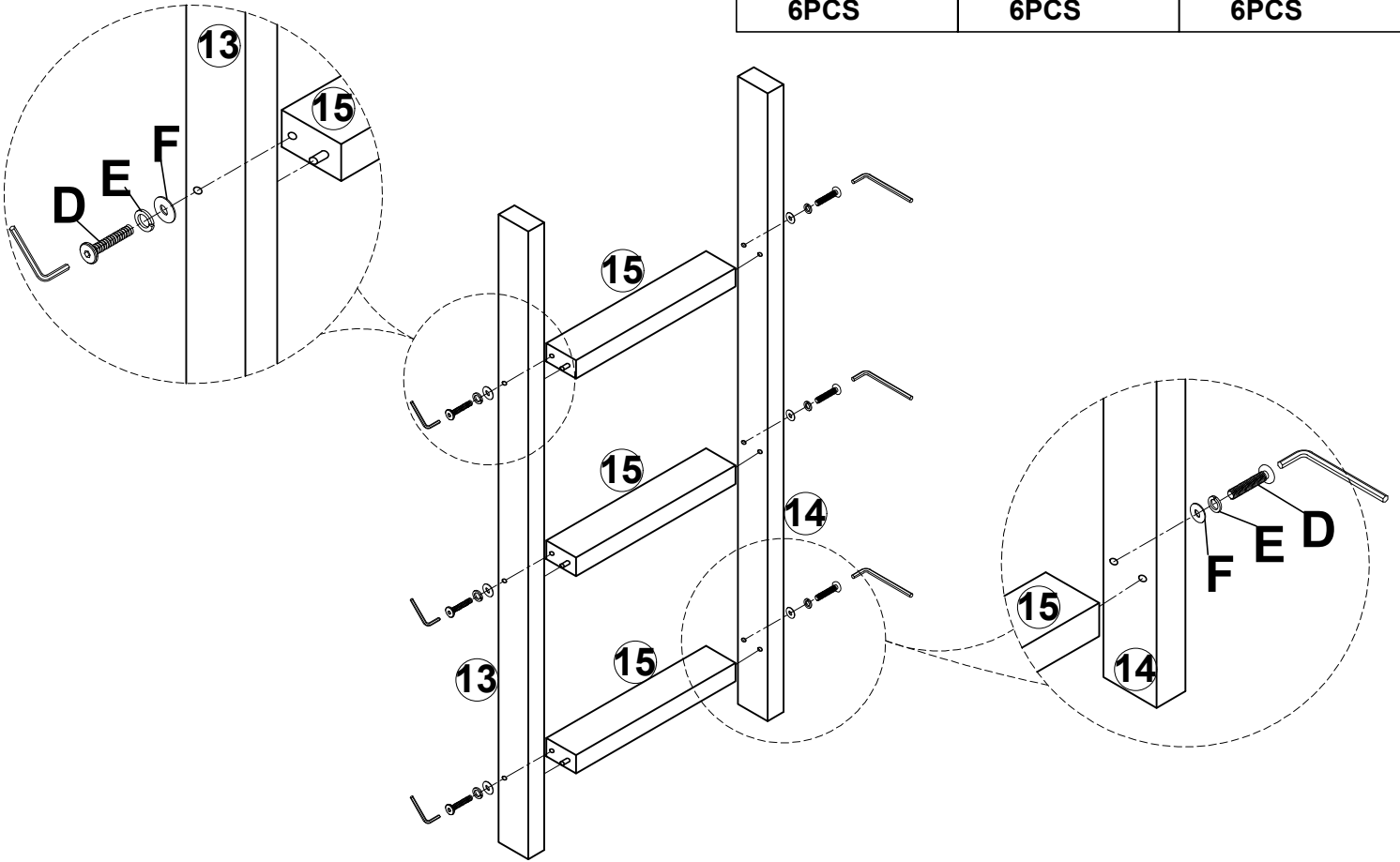
<b>E</b>		<b>F</b>		<b>D</b>	
6PCS		6PCS		6PCS	

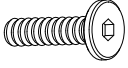

# STEP 7

<b>J</b>		<b>K</b>		<b>G</b>	
4PCS		4PCS		4PCS	

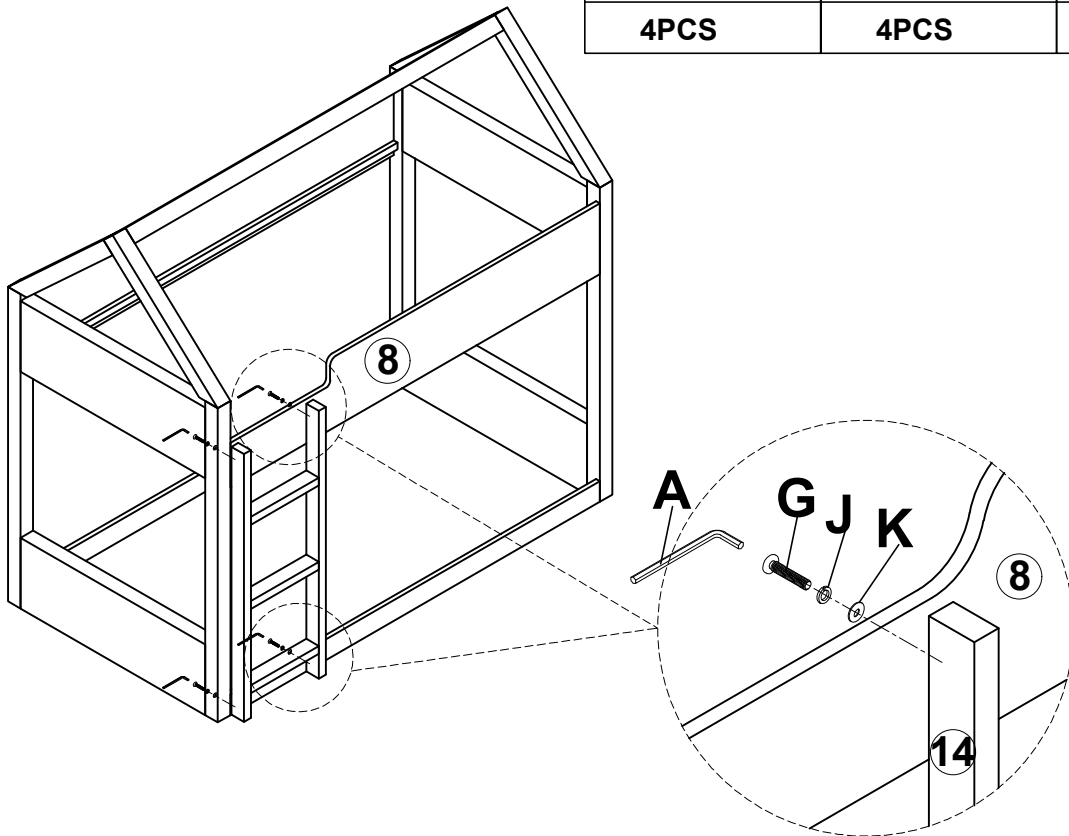

# STEP 8

L

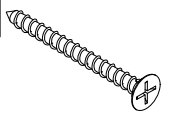

26PCS

