

# Assembly Instructions

Warnings: You must read this before you proceed.

## Club Chair

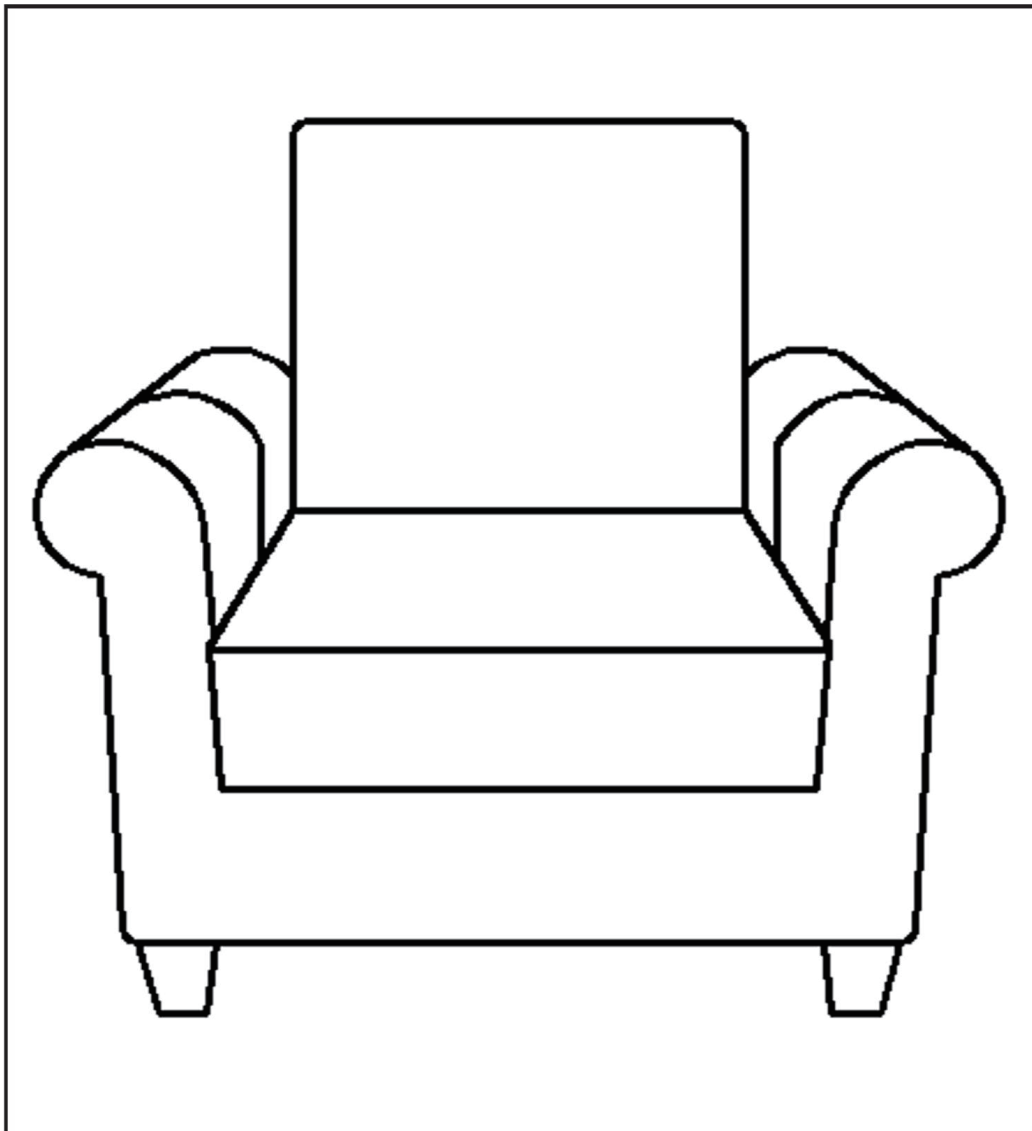

# Parts List

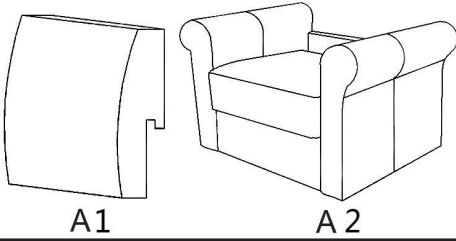
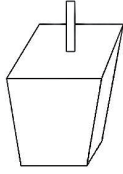
| Label | Picture   | Description | QTY |
|-------|---|-------------|-----|
| A     | <br>A1                      A2 | Chair       | 1   |
| B     |                                | Wooden Leg  | 4   |





# Hardware

| Label | Picture   | Description | QTY |
|-------|---|-------------|-----|
| 1     |  | Washer Ring | 7   |

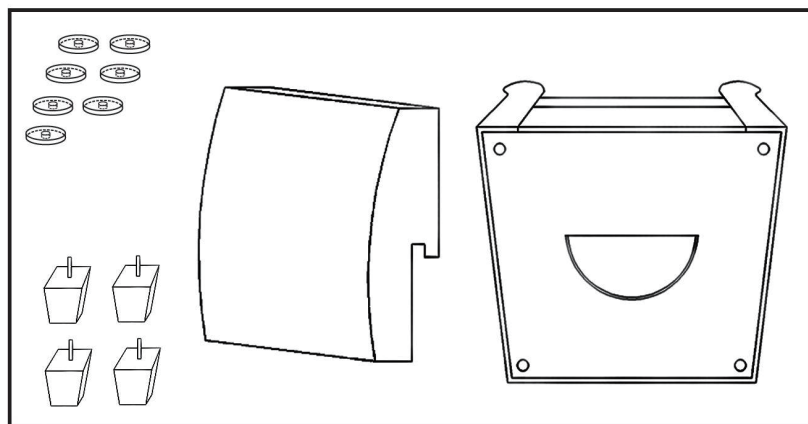
# Assembly Preparation

Before Beginning Assembly:



- 
 • Read instructions, cover to cover-
- 
 • Have 2 adults on hand for assembly-
- 
 • Do not assemble on flooring or carpet-
- 
 • Assemble on a clean non-marring surface (packing foam)-
- 
 • Save all packaging until finished-

# Assembly Steps

## Step 1

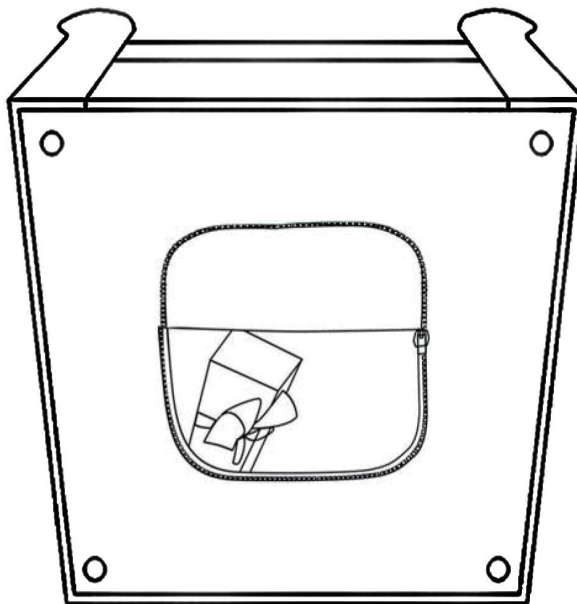

Position the Chair on its back, as shown.  
Unzip to open and remove the 4 Wooden Legs. Close the Pocket.

## Step 2

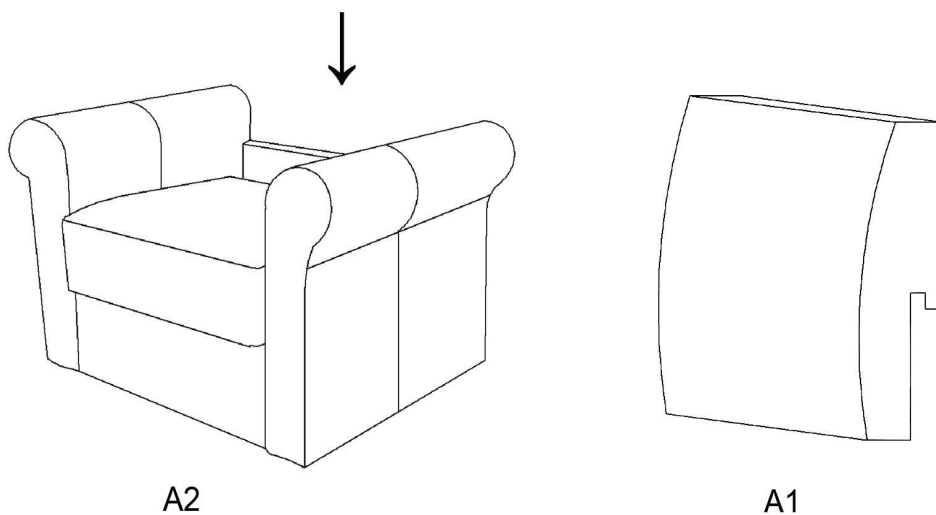

Position yourself behind the chair. Place the back rest (A1) into the body slot (A2), while tilting the back rest slightly forward. Then gently pull the back rest towards you while pushing it down all the way into the body slot.

Step 3

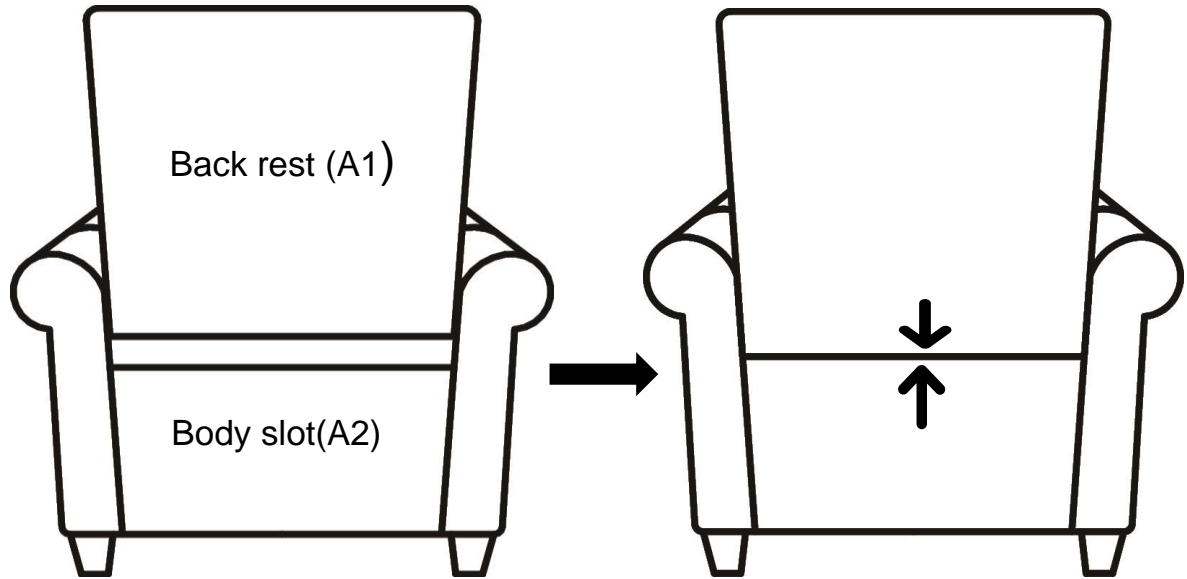

If you find a gap between the Back rest(A1) and Body slot(A2), please push the Back rest(A1) back and forth slightly, while pressing the Back rest downwards until the gap disappears

## Assembly Steps



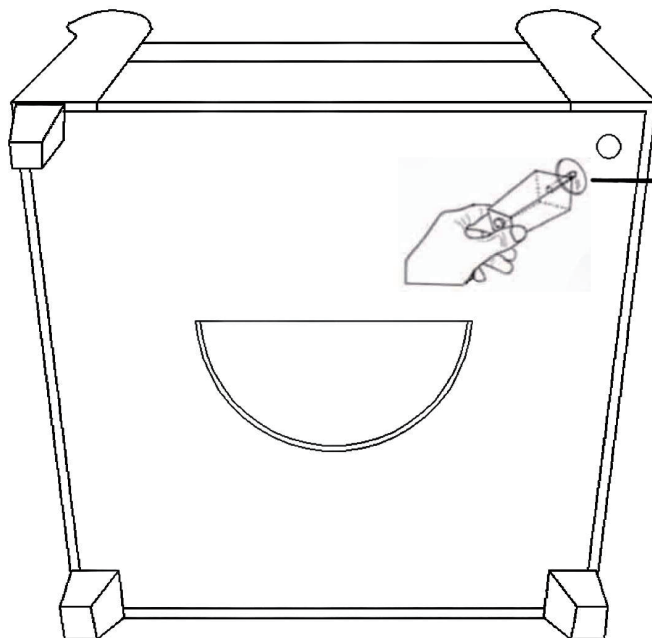

















### Step 4



Use Washer Ring to achieve stability.

Install the leg into the chair by putting a Washer Ring (optional ) on the threaded stem and then insert the threaded stem into the threaded hole at each corner of the bottom of the chair. Tighten by turning leg clockwise. Repeat the same procedure to install the other 3 remaining legs.

## Care & Maintenance

-   • Do not put hot items directly on furniture surface
  -   • Do not clean furniture with harsh cleansers or polish.
  -   • Do not place furniture under direct sunlight.
  -   • Do not place furniture near heating or cooling vents.
  -   • Do not write on furniture without a padded barrier to protect the surface.
  -   • Do not place furniture outside . For indoor use only .
  -   • Not for commercial use. For residential use only .
  -   • Stains may be removed with mild soap solution and damp cloth.
  -   • Children should not climb or jump on the furniture.
- 
-   • Dust and pick-up spills using a clean, non-colored, lint-free cloth .