











**IMPORTANT!! PLEASE READ ENTIRE
INSTRUCTION SHEET BEFORE ASSEMBLY!!
6PCS Folding Set**

Identify all parts packed in the carton against the parts list. Remove all protective materials. Place parts on a non-abrasive surface. If you are missing any parts or Are unsure how to proceed with assembly, please call customer service center

Do not attempt to assemble the product if any parts are missing or damaged .

PART LIST

PART LIST							
A	Table Top		1	F	Button Tube		1
B	Table Leg		4	AA	M6x58mm Bolt		8
C	Leg Connector 1		1	BB	Nut		8
D	Leg Connector 2		1	CC	Plastic bolt cap		8
E	Umbrella Body		1	DD	Allen Wrench		1

TABLE

Step 1

Place table top (A) on a flat, soft surface.

Insert table legs (B) into the hole of the plastic part on the table rim.

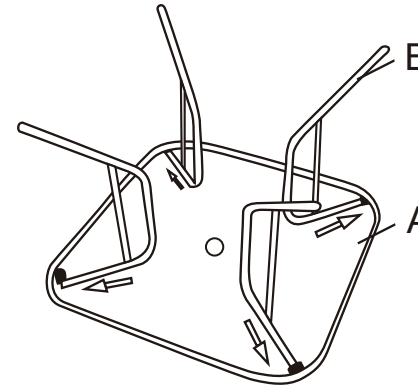

Step 2

Attach the leg connector 1(C) and 2(D) to the table legs (B) by using bolts (AA) with nuts (BB) . Do not fully tighten all bolts until ensure all bolts are aligned and assembled correctly.

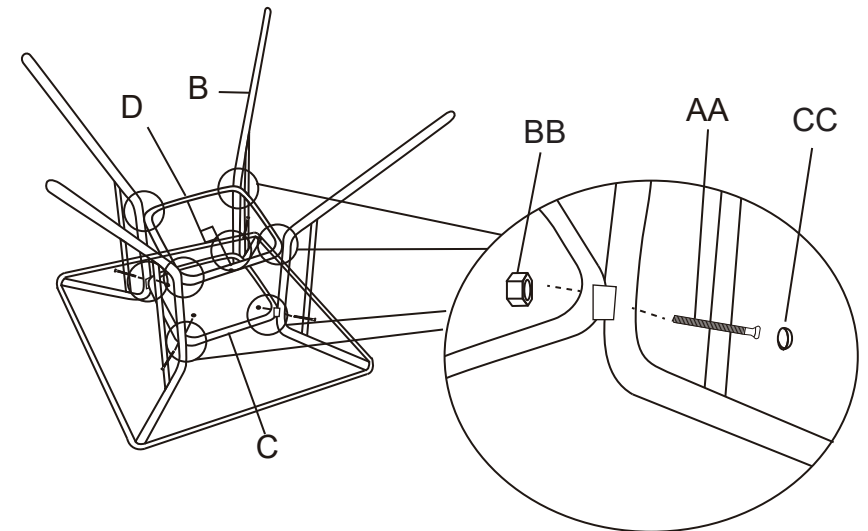

Step 3

Carefully turn the table over and set it down on its legs. The table is ready for your enjoyment.



UMBRELLA

Step 1

Insert umbrella body (E) into the bottom tube (F). Then push the handle on the bottom tube in order to secure the umbrella body (E).

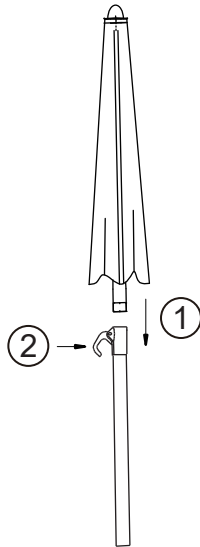

Step 2

Insert the umbrella into the umbrella hole on table. Push the umbrella canopy to fully extension by hand.



WARNING:

To avoid damage to your table: An umbrella base must be used at all time. The umbrella should be removed and stored in the event of wind, rain, hail, sleet, snow or any other inclement weather.