

ASSEMBLY INSTRUCTIONS

36 INCH BATH VANITY-CABINET

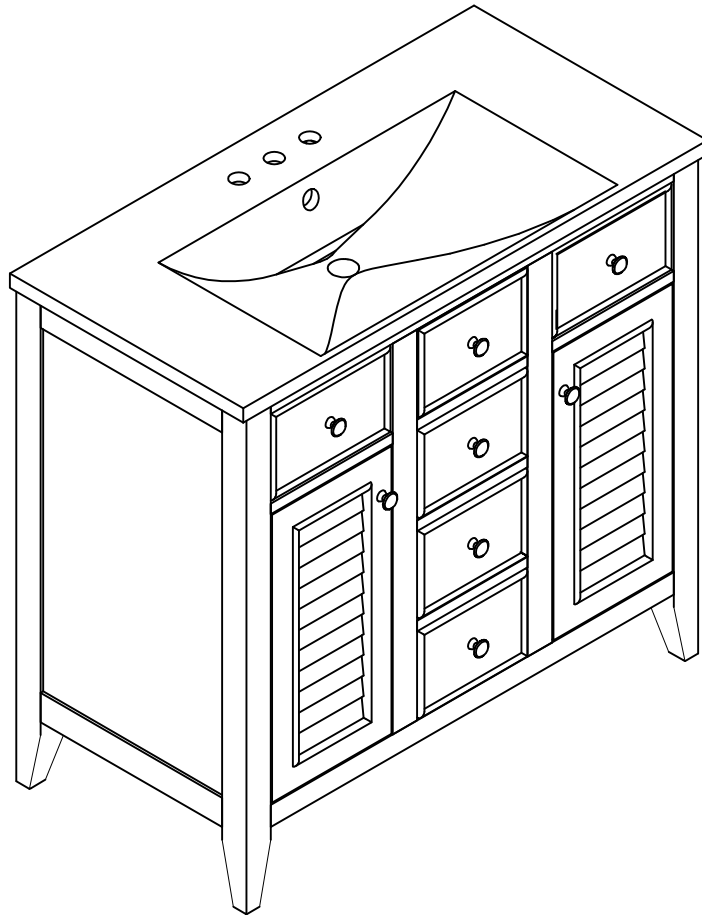

Thank you for purchasing this quality product. Be sure to check all packing material carefully for small parts which may have come loose inside the carton during shipment. Separate, identify and count all parts and hardware. Compare with the parts list to be sure all parts are present.
"DO NOT TIGHTEN SCREWS UNTIL COMPLETELY ASSEMBLED"

*** Use of power tool to assemble this product will invalidate any claim and damage this product making unsafe !!!**
*** Please assemble on a clean soft surface to avoid damage.**

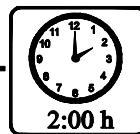

Tools Required

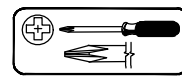

(Not included)

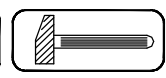

(Not included)

IMPORTANT:

PLEASE READ INSTRUCTION BEFORE STARTING THE ASSEMBLY

Thank you for buying our products.

Please read the installation manual carefully before installation,

we need you to follow the instructions on the accessories and hardware

step by step assembly complete, our instructions are very detailed.

Products are environmentally friendly products,

Please rest assured that you do not soak in water, do not place very heavy items,

do not malicious push and pull,

if you have any problems in the process of assembly and use, please contact us.

Thank you again for your purchase of our products,

I wish you a happy life.

Detail View - CABINET

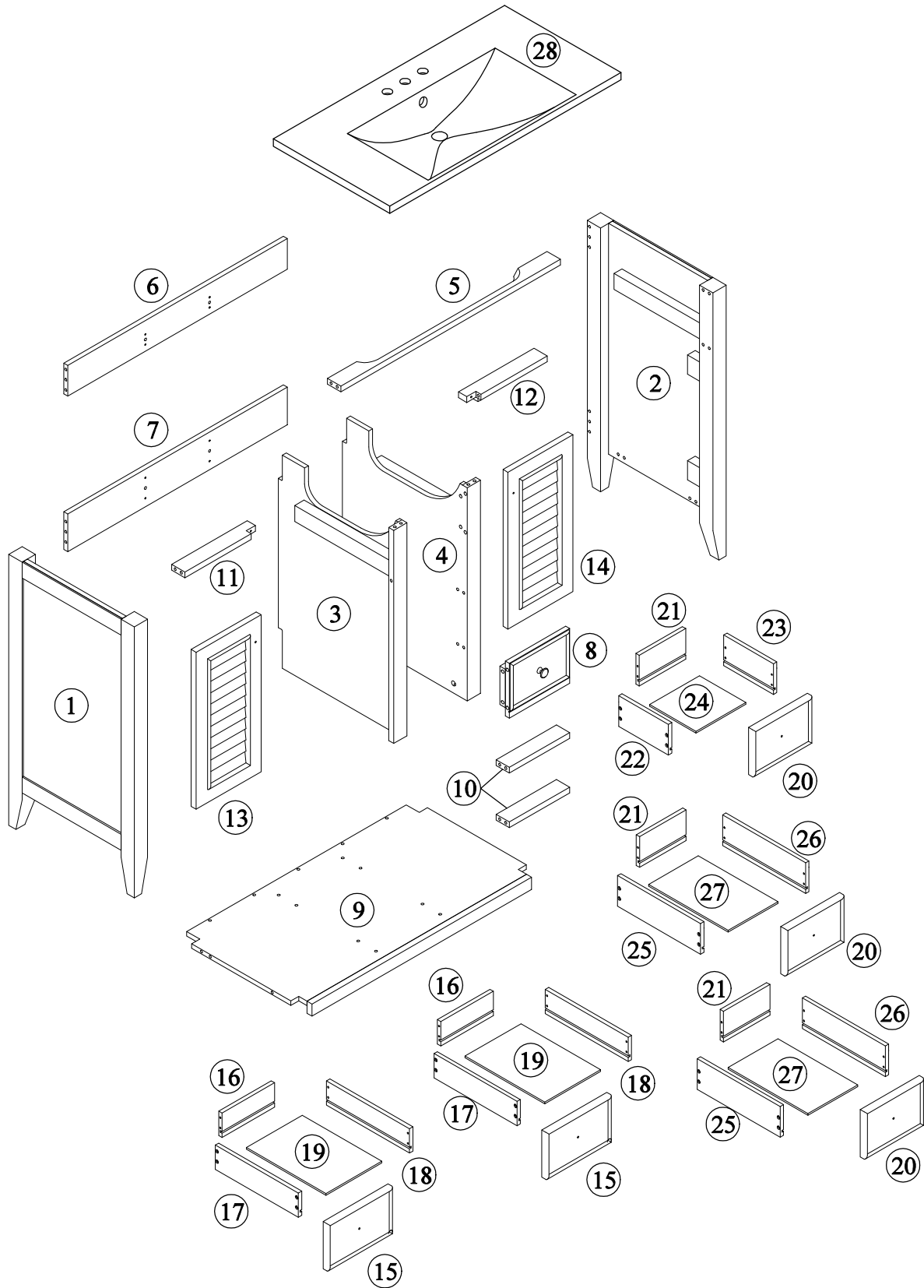

Identifying the Hardware-Identify the hardware using the illustrations below.



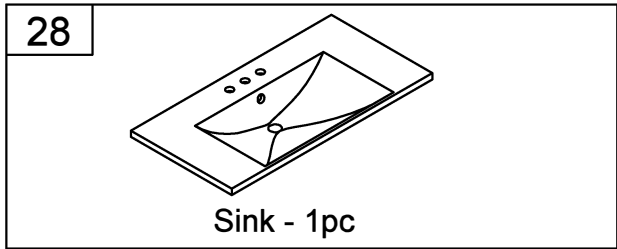

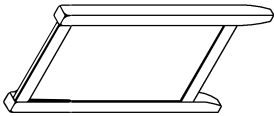
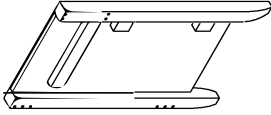
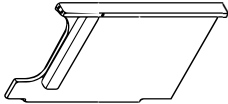
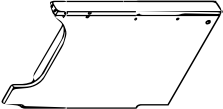
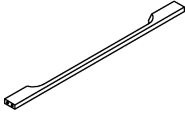
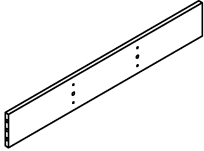
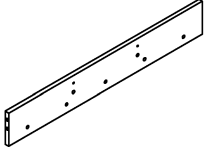
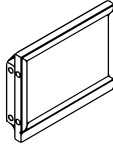
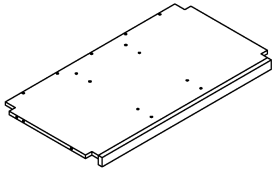
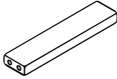

Part List

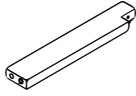
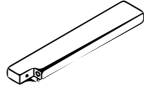
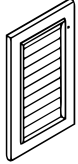
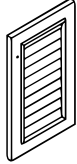
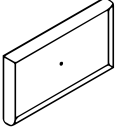

Part List

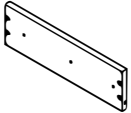
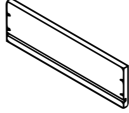
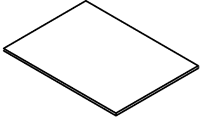
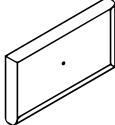
| | | | |
|---------------------------|---|--------------------------|---|
| 1 |  | 2 |  |
| Side Panel (L) - 1pc | | Side Panel (R) - 1pc | |
| 3 |  | 4 |  |
| Mid Fixed Panel (L) - 1pc | | Mid Fixed Panel (R)- 1pc | |
| 5 |  | 6 |  |
| Top Crossbar - 1pc | | Back Panel Top - 1pc | |
| 7 |  | 8 |  |
| Back Panel Bottom - 1pc | | Fake drawer - 1pc | |
| 9 |  | 10 |  |
| Mid Fixed Panel - 1pc | | Mid Crossbar - 2pcs | |

Part List

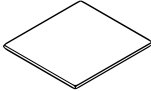
| | |
|---|---|
| <p>11</p>  <p>Mid Crossbar (L) - 1pc</p> | <p>12</p>  <p>Mid Crossbar (R) - 1pc</p> |
| <p>13</p>  <p>Door (L) - 1pc</p> | <p>14</p>  <p>Door (R) - 1pc</p> |
| <p>15</p>  <p>Top Drawer Front - 2pcs</p> | <p>16</p>  <p>Top Drawer Back - 2pcs</p> |
| <p>17</p>  <p>Top Drawer Side (L) - 2pcs</p> | <p>18</p>  <p>Top Drawer Side (R) - 2pcs</p> |
| <p>19</p>  <p>Top Drawer Bottom - 2pcs</p> | <p>20</p>  <p>Mid Drawer Front - 3pcs</p> |
| <p>21</p>  <p>Mid Drawer Back - 3pcs</p> | <p>22</p>  <p>Mid Drawer Top Side (L) - 1pc</p> |
| <p>23</p>  <p>Mid Drawer Top Side (R) - 1pc</p> | <p>24</p>  <p>Mid Drawer Bottom 1- 1pc</p> |

Part List

25

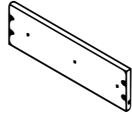

Mid Drawer Bottom Side (L) - 2pcs

26

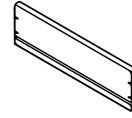





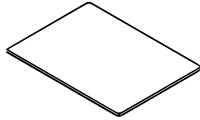





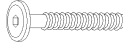

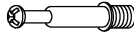

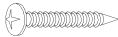
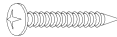
Mid Drawer Bottom Side (R) -2pcs

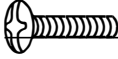
27

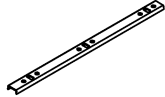
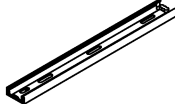
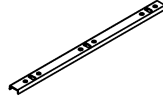

Mid Drawer Bottom 2 - 2pcs

Hardware List

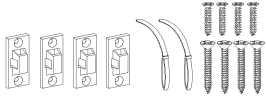
| | | |
|--|---|--|
| <p>A</p>  <p>ø13x1/4"x30mm</p> | <p>B</p>  <p>ø1/4"x16x1mm</p> | <p>C</p>  <p>ø6x35mm</p> |
| <p>Hex-Head bolts - 4pcs Washer - 4pcs Three in one bolts - 29pcs</p> | | |
| <p>D</p>  <p>ø14.5x12mm</p> | <p>E</p>  <p>ø8xø4x25mm</p> | <p>F</p>  <p>ø8xø4x32mm</p> |
| <p>Three in one lock - 29pcs Round head screw - 8pcs Round head screw - 42pcs</p> | | |
| <p>G</p>  | <p>H</p>  <p>ø5/32"x20mm</p> | <p>J</p>  <p>ø5/32"x32mm</p> |
| <p>Handle - 8pcs Handle screw - 3pcs Handle screw - 5pcs</p> | | |
| <p>K</p>  | <p>L</p>  <p>ø7xø3.5x15mm</p> | <p>M</p>  <p>ø300x35mm</p> |
| <p>Damping hinge - 4pcs Flat head screw - 24pcs Slide rails - 8pcs</p> | | |
| <p>N</p>  <p>ø298x18mm</p> | <p>O</p>  <p>ø200x35mm</p> | <p>P</p>  <p>ø198x18mm</p> |
| <p>Slide rails - 8pcs Slide rails - 2pcs Slide rails - 2pcs</p> | | |
| <p>Q</p>  <p>ø6xø3x12mm</p> | <p>R</p>  <p>ø8x30mm</p> | <p>S</p>  <p>4mm</p> |
| <p>Flat head screw - 60pcs Wood dowel - 34pcs Allen key - 1pc</p> | | |
| <p>T</p>  <p>Anti fall hardware - 1set</p> | | |

STEP: 1

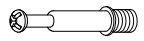

C

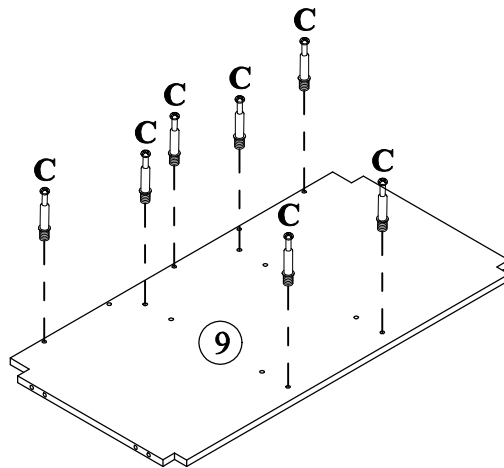
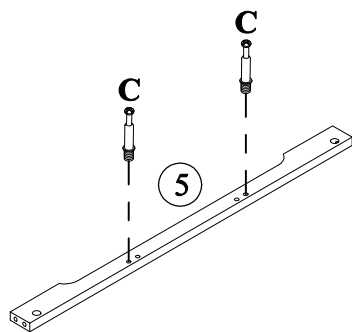
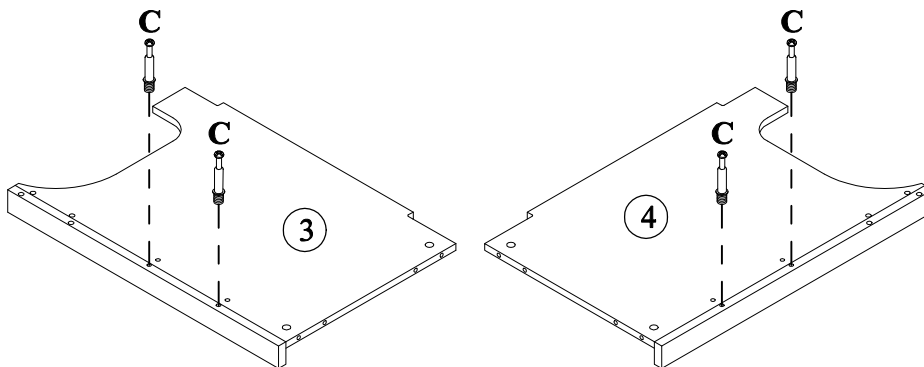
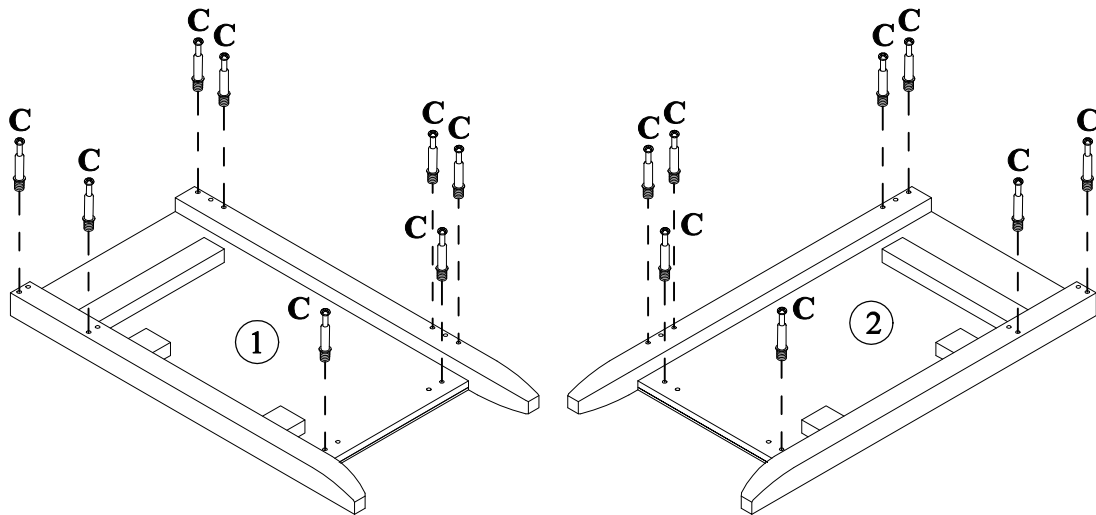

29PCS



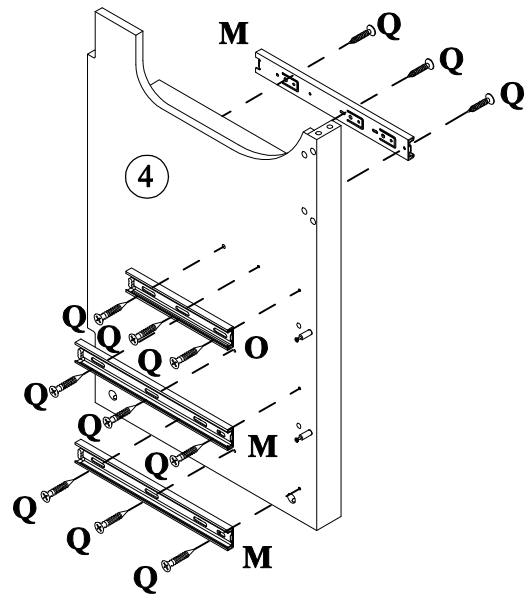
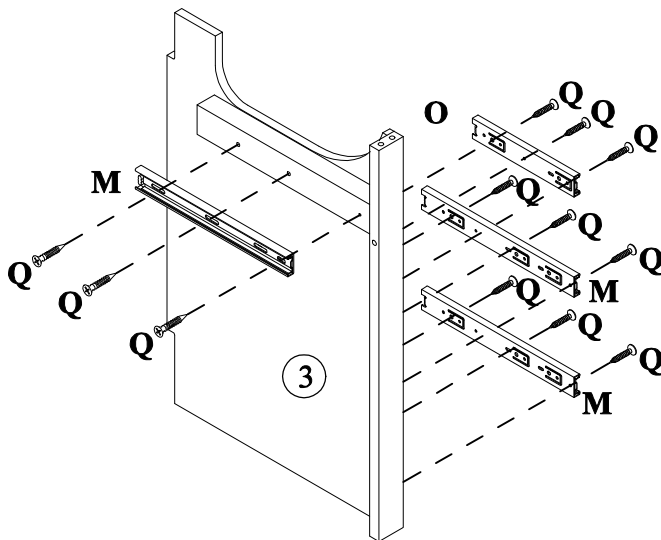
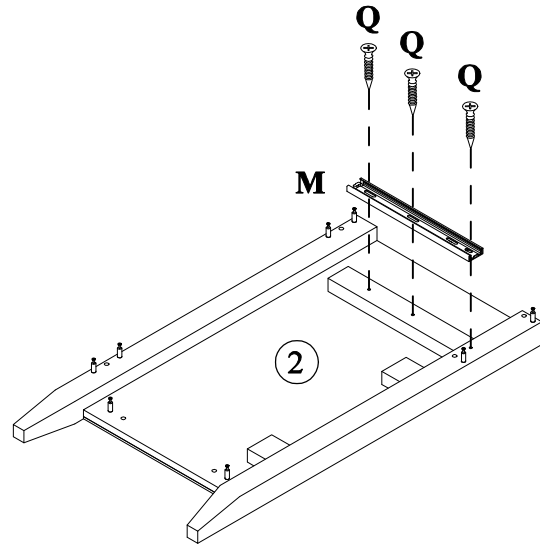
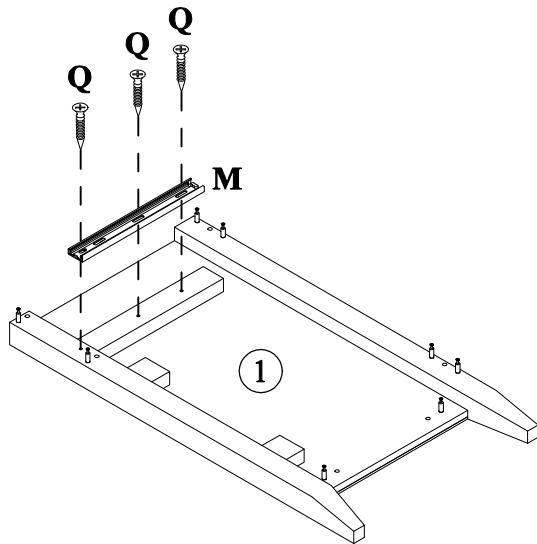

STEP: 2

| | | | | | |
|-------------|--|-------------|---|--------------|---|
| M |  | O |  | Q |  |
| 8PCS | | 2PCS | | 30PCS | |

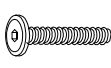

STEP: 3

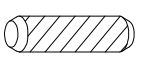
| | | | |
|---|--|---|---|
| A | B | D | R |
|  |  |  |  |
| 4PCS | 4PCS | 4PCS | 8PCS |

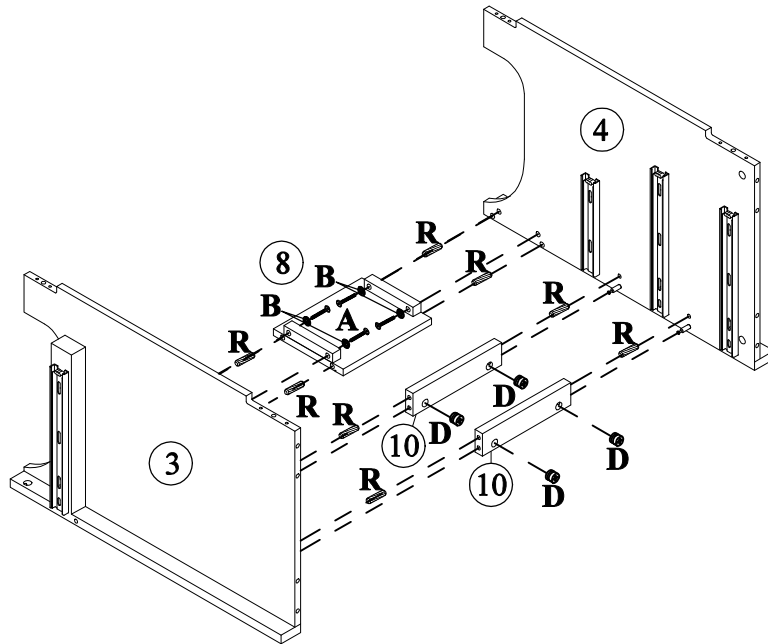

STEP: 4

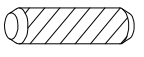
| | |
|---|---|
| E | R |
|  |  |
| 8PCS | 4PCS |

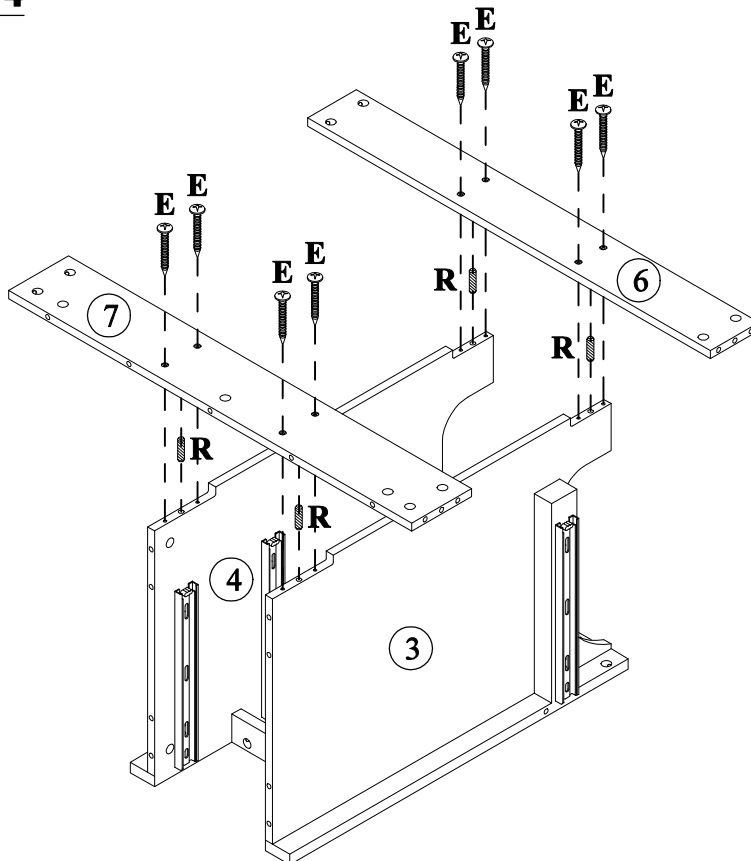

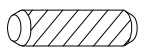

STEP: 5

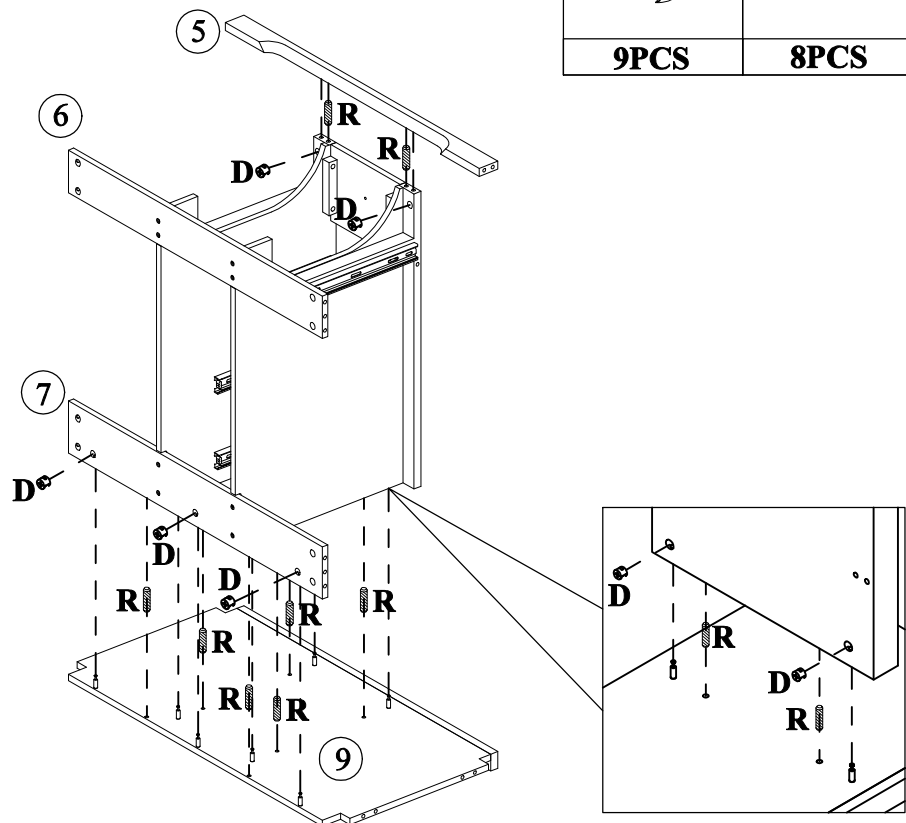
| | | | |
|----------|---|----------|---|
| D |  | R |  |
| | 9PCS | | 8PCS |



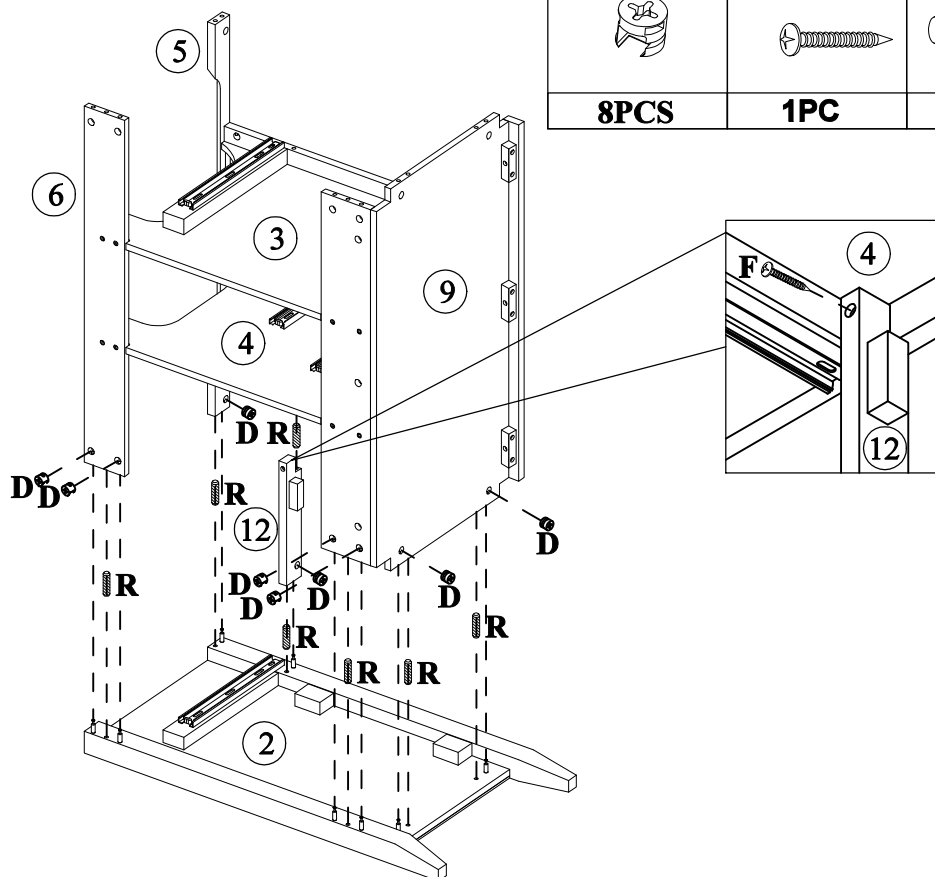

STEP: 6

| | | | | | |
|----------|--|----------|---|----------|---|
| D |  | F |  | R |  |
| | 8PCS | | 1PC | | 7PCS |



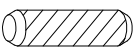

STEP: 7

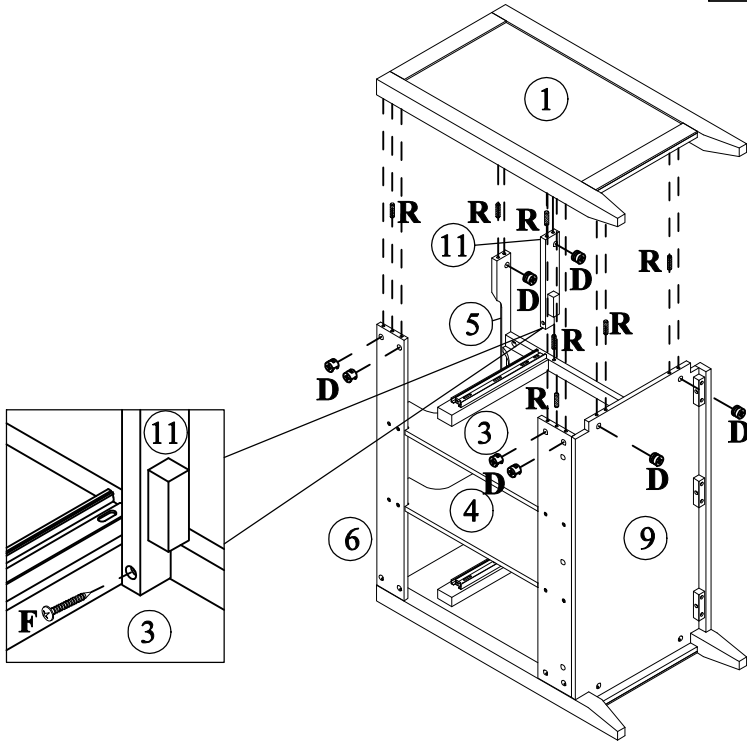
| | | | | | |
|-------------|--|------------|---|-------------|---|
| D |  | F |  | R |  |
| 8PCS | | 1PC | | 7PCS | |



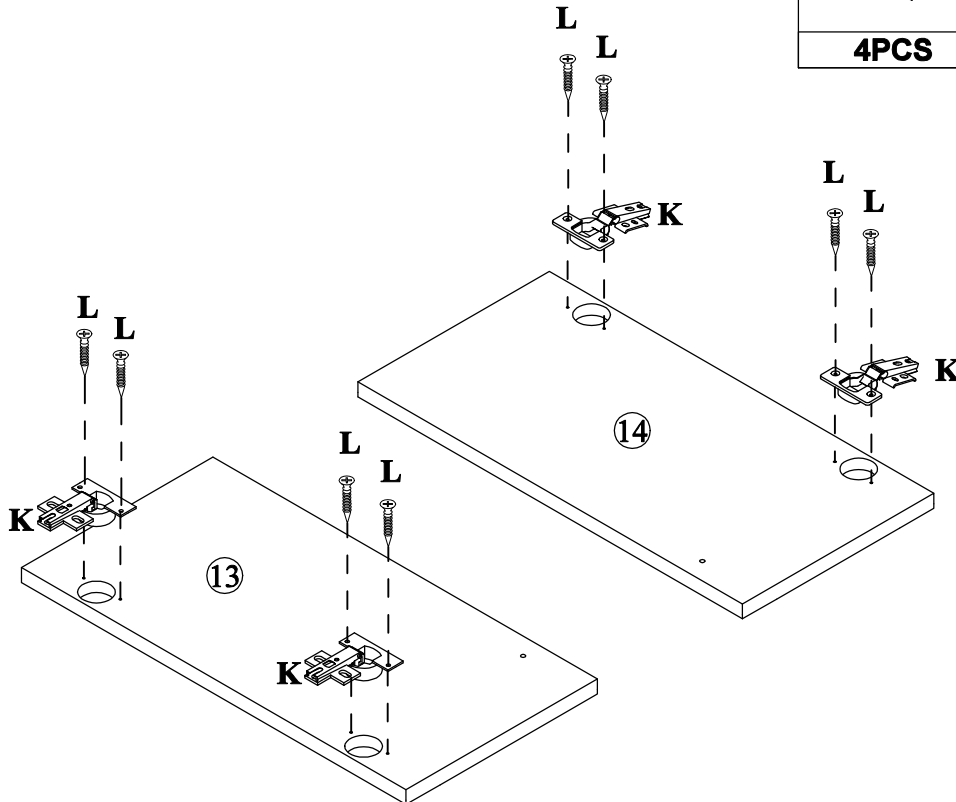

STEP: 8

| | | | |
|-------------|---|-------------|---|
| K |  | L |  |
| 4PCS | | 8PCS | |



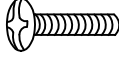

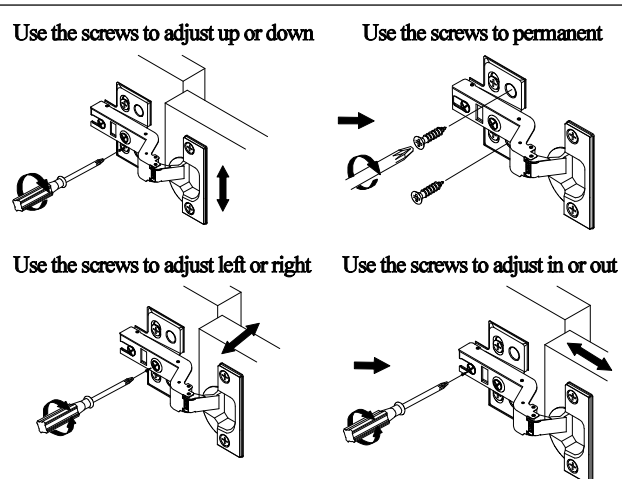
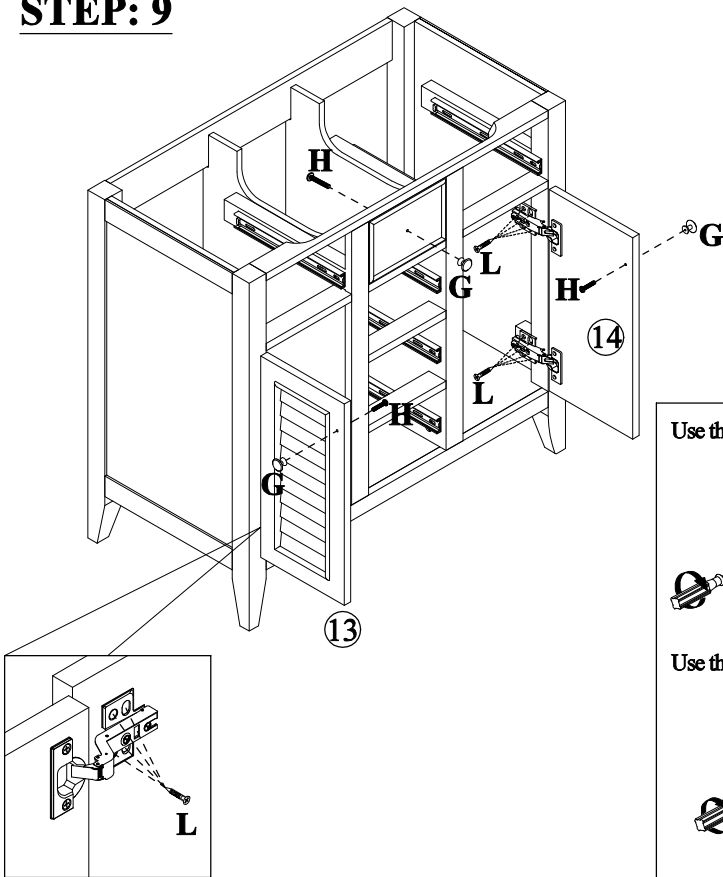

STEP: 9

| | | | | | |
|-------------|--|-------------|---|--------------|---|
| G |  | H |  | L |  |
| 3PCS | | 3PCS | | 16PCS | |

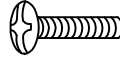
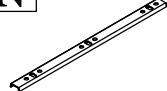

STEP: 10

| | | | | |
|---|---|--|---|---|
| F | G | J | N | Q |
|  |  |  |  |  |
| 16PCS | 2PCS | 2PCS | 4PCS | 12PCS |

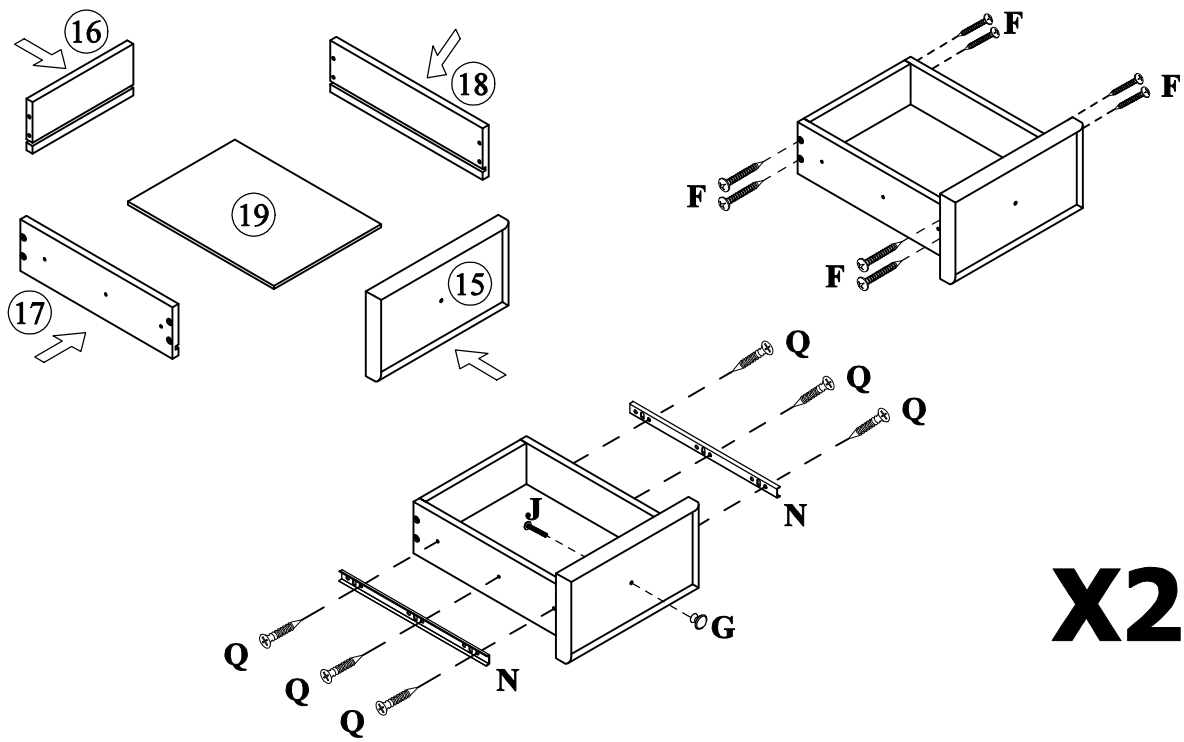



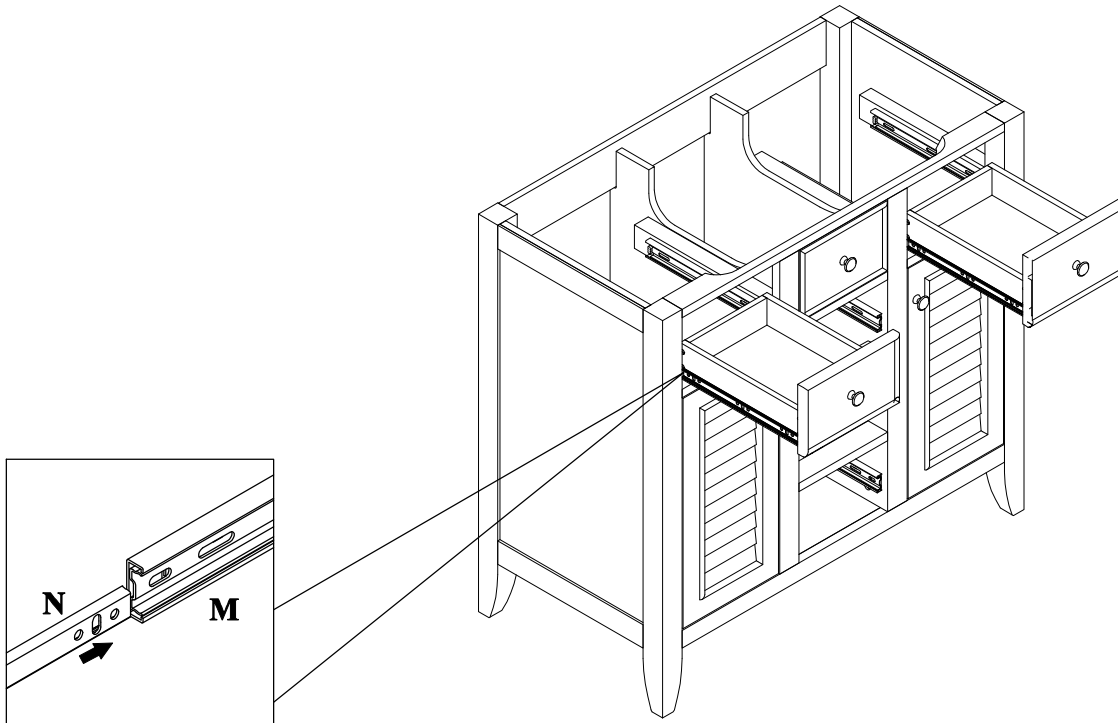

X2

STEP: 11

The structure of the cabinet is quite stable, if you are not sure, you can use anti-falling hardware



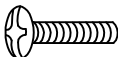
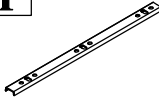

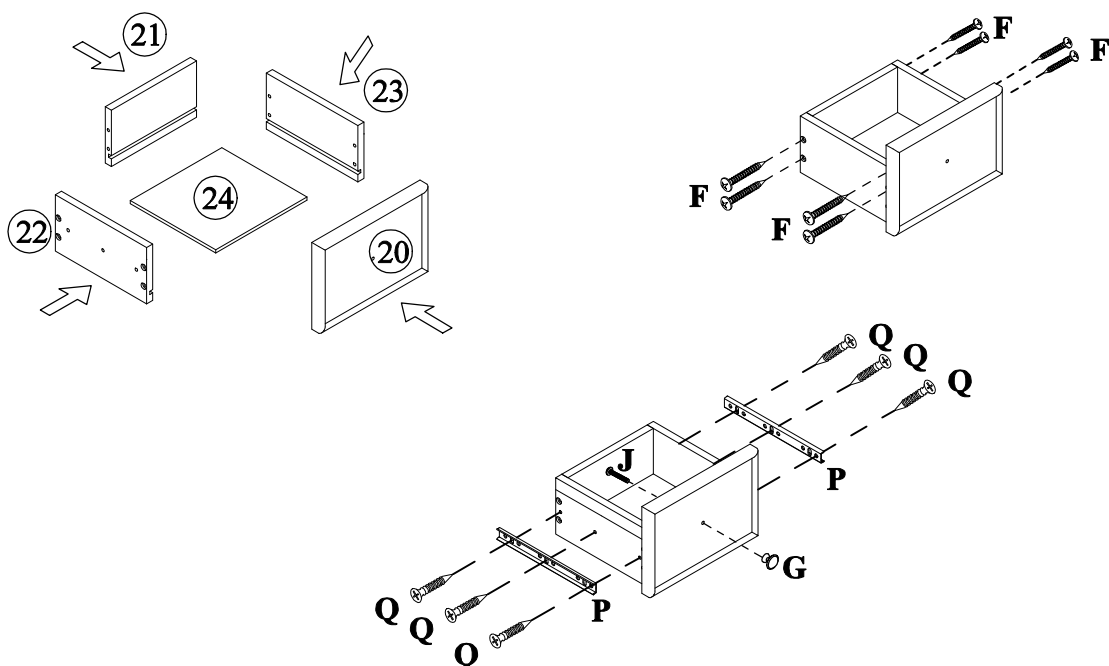

STEP: 12

| F | G | J | P | Q |
|---|---|--|---|---|
|  |  |  |  |  |
| 8PCS | 1PC | 1PC | 2PCS | 6PCS |

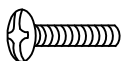
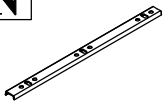

STEP: 13

| | | | | |
|---|---|--|---|---|
| F  | G  | J  | N  | Q  |
| 16PCS | 2PCS | 2PCS | 4PCS | 12PCS |

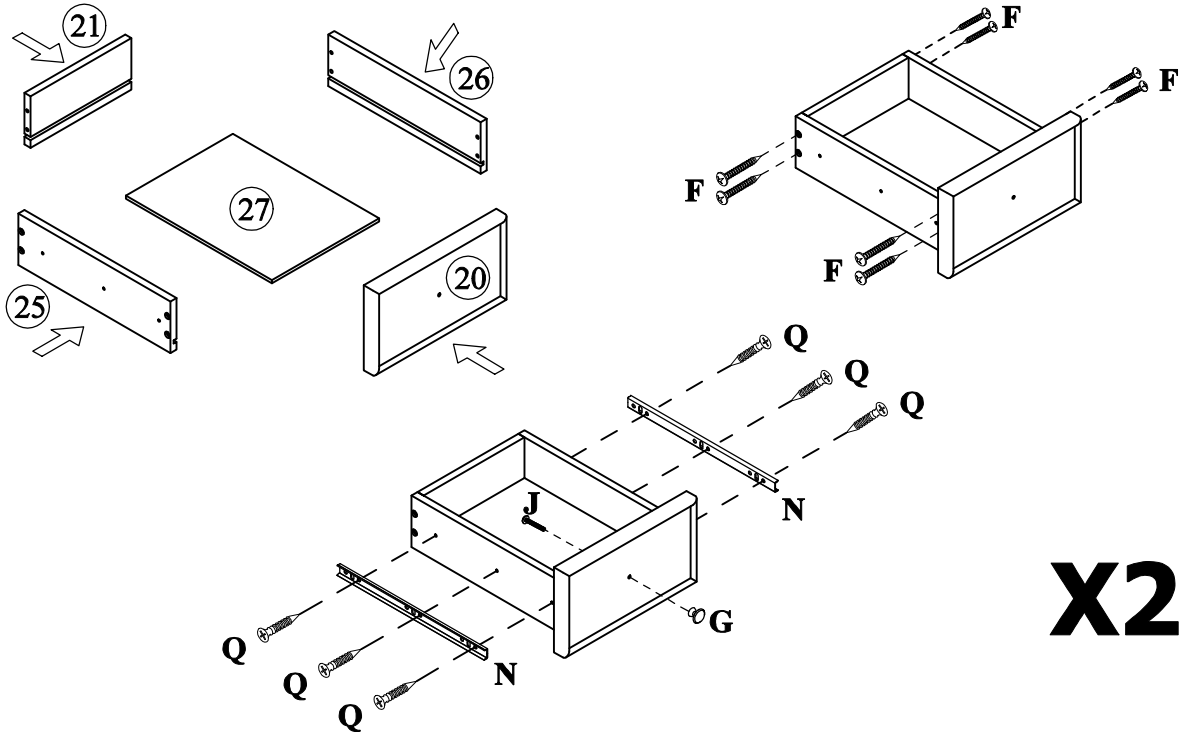

X2

STEP: 14

Install the sink on the cabinet with glue.
Let stand for 24 hours

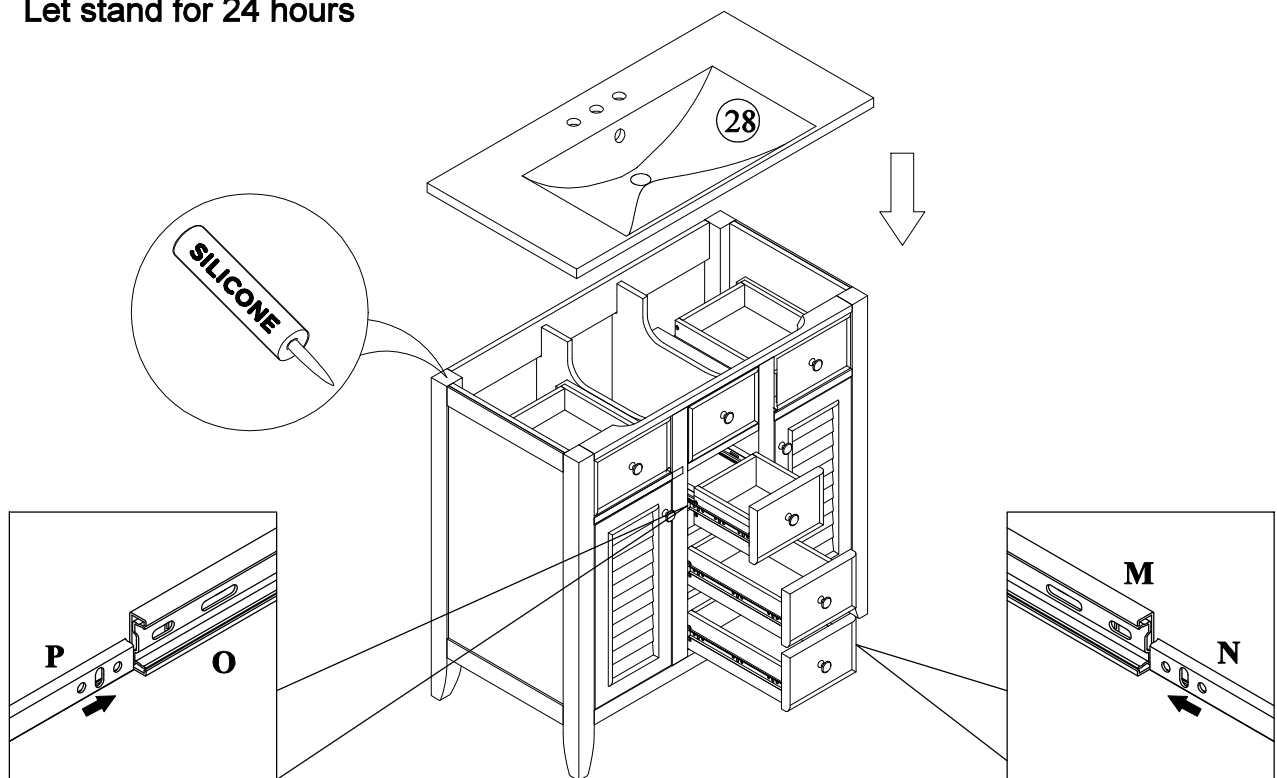

STEP: 15

