

# ASSEMBLY INSTRUCTIONS

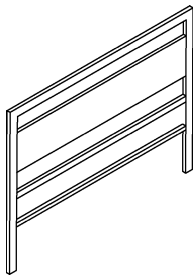

A\*1PC

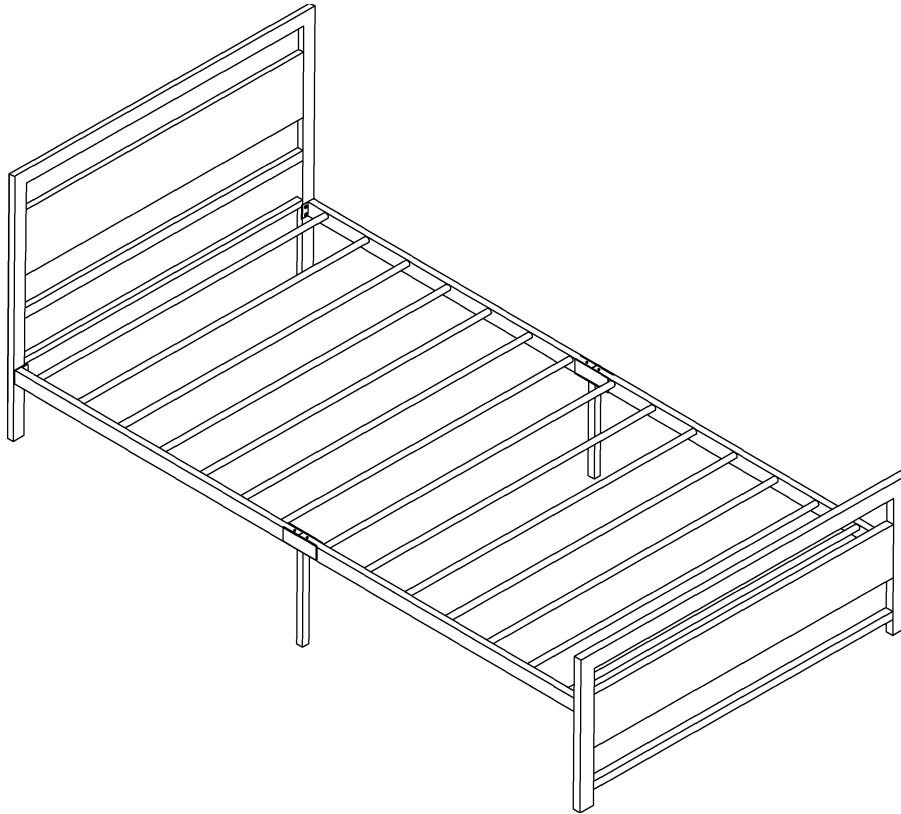
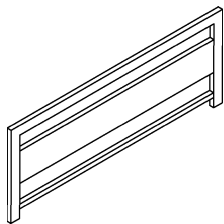

B\*1PC

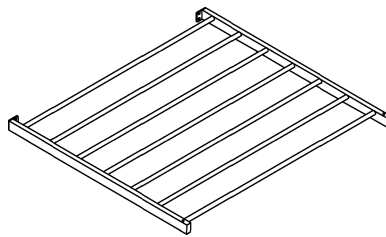

C\*2PCS



D\*2PCS

E\*8PCS



6. 35\*16MM

F\*4PCS



M8\*50MM

G\*4PCS



M8

H\*1PC

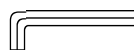

5M

I\*1PC



4M

J\*1PC

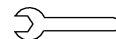

Note: Pls do not tighten all bolts until the bed is assembled completely

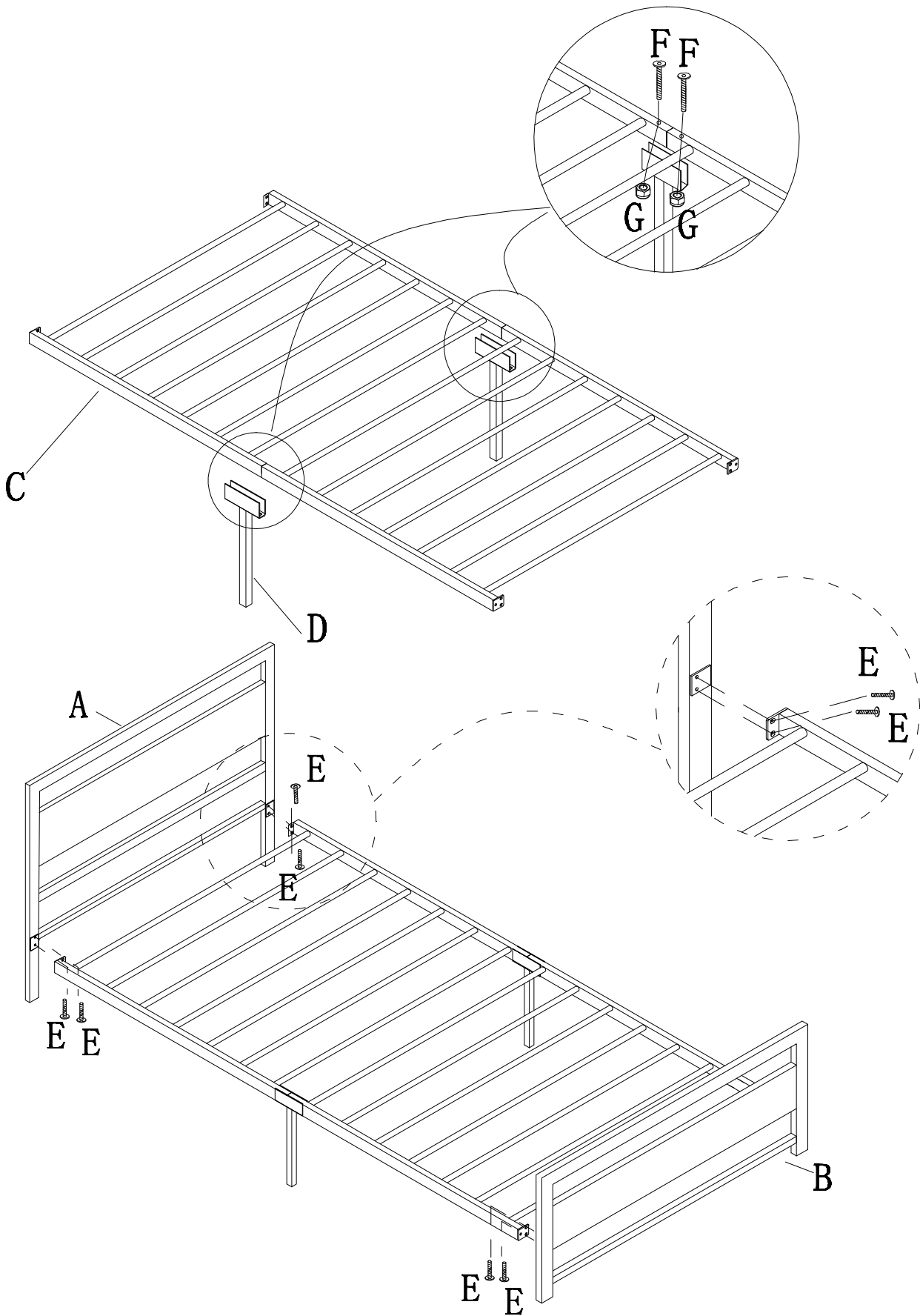

# ASSEMBLY INSTRUCTIONS

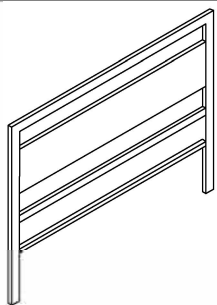
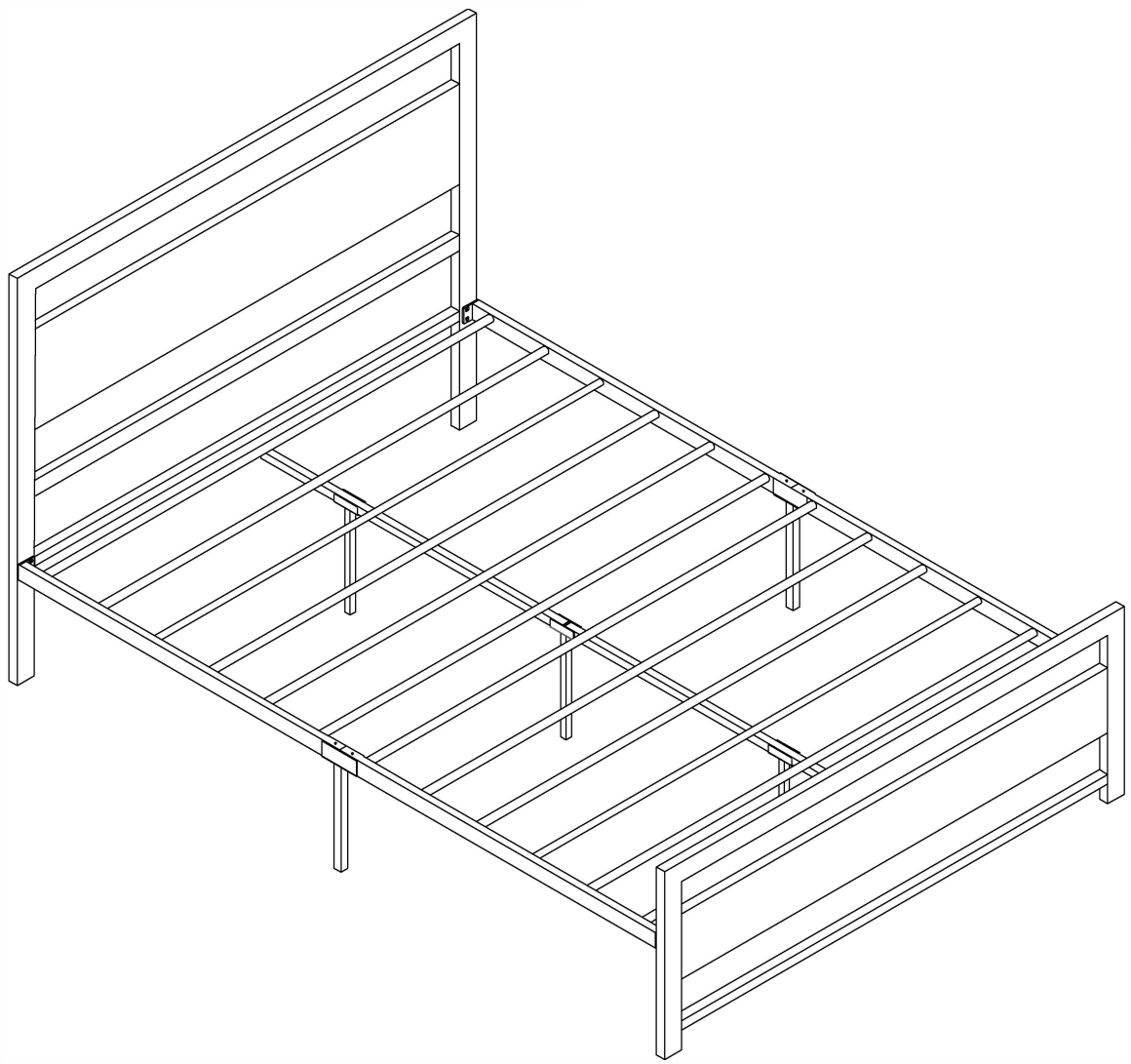

A\*1PC

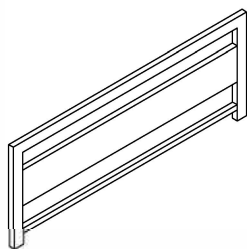

B\*1PC

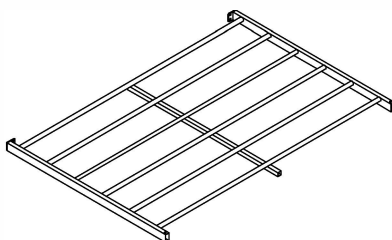

C\*2PCS



D\*2PCS



E\*3PCS

F\*8PCS



6.35\*16MM

G\*4PCS



M8\*50MM

H\*6PCS



6.35\*25MM

I\*4PCS



M8

J\*1PC



5M

K\*1PC



4M

L\*1PC



Note: Pls do not tighten all bolts until the bed is assembled completely

