

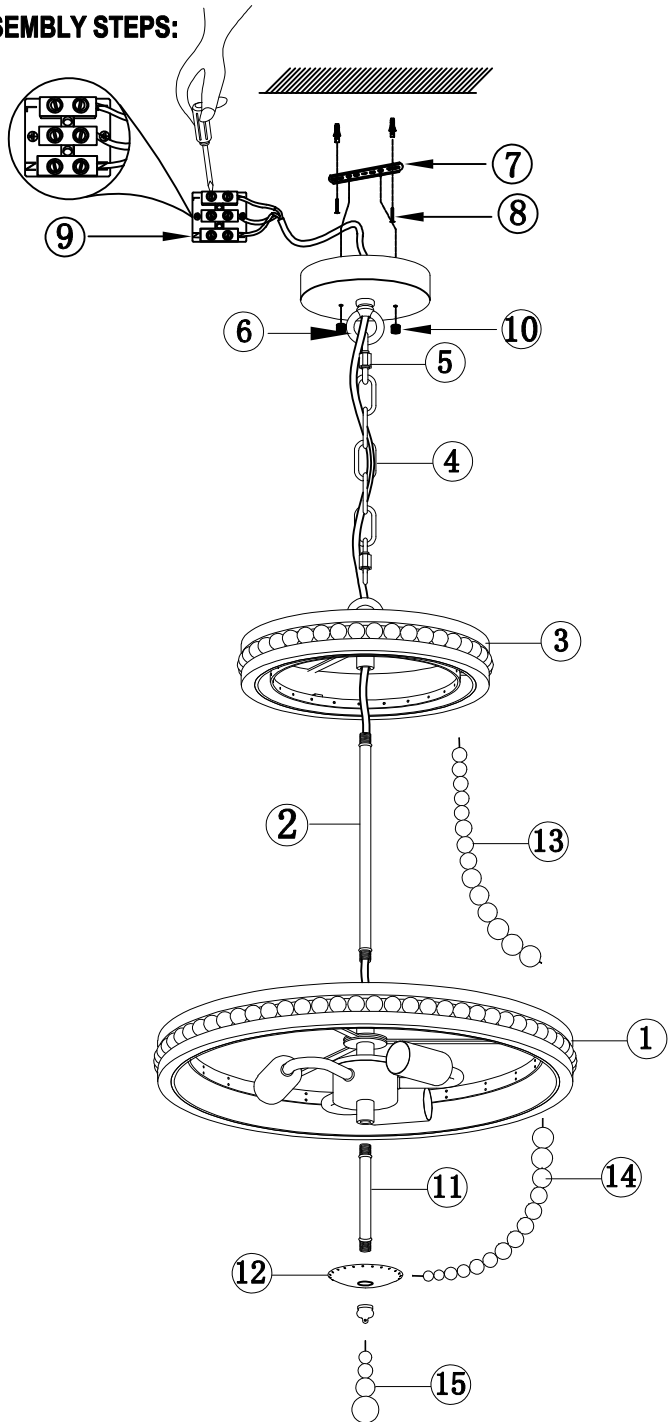









FIXTURE ASSEMBLY STEPS:

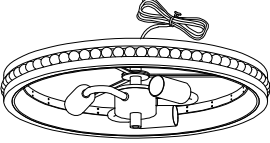

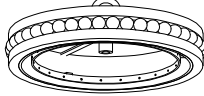
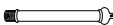
DESCRIPTION	PICTURE	CODE	QTY
Mounting Plate		7/10	1 SET
Mounting Box Screw		8	2 PCS
P3 Wiring Cap		9	1 PCS
Canopy+Loop + Safety buckle+Chain		4/5/6	1 SET
Combination circle		1	1 SET
On the pole		2	1 PCS
Combination circle		3	1 SET
Downswing		11	1 SET
Semicircular lid		12	1 PCS
Wooden beads		13	24 PCS
Wooden beads		14	24 PCS
Wooden bead pendant		15	1 PCS

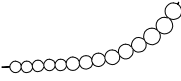
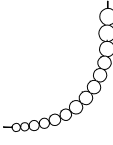
WARNING - if any Special Control Devices are used with this Fixture, Follow the instructions Carefully to assure full compliance With N. E. C. requirements. if there are any questions, contact a Qualified Electrical Contractor.
 CAUTION - All glass is fragile, use care when handling Glass component (s) and or Lamp (s).

CANOPY MOUNTING & WIRE CONNECTION ASSEMBLY STEPS:

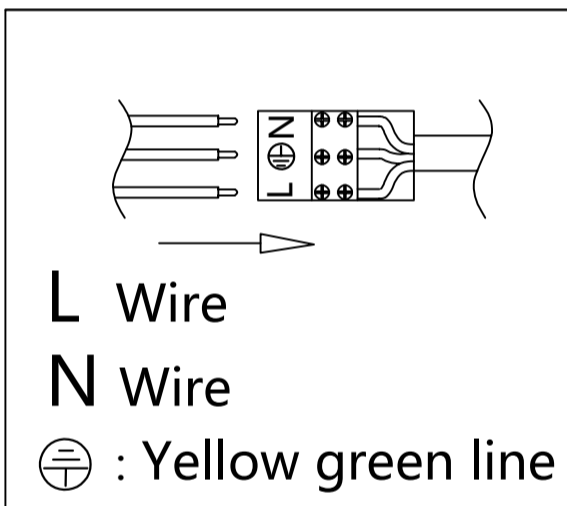
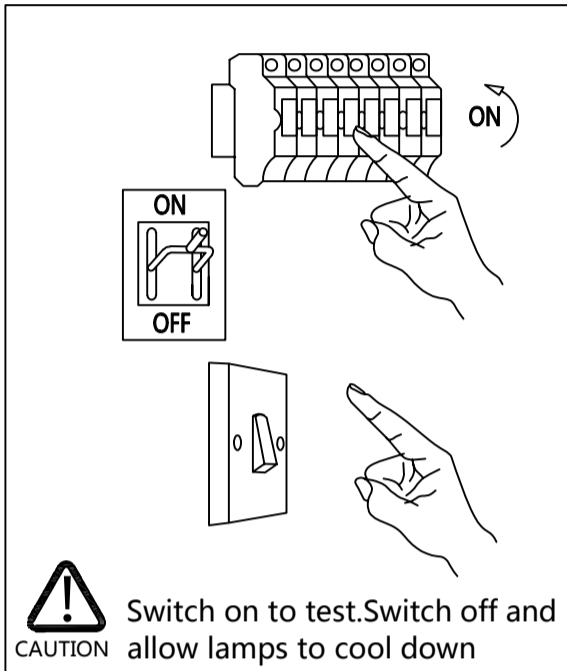
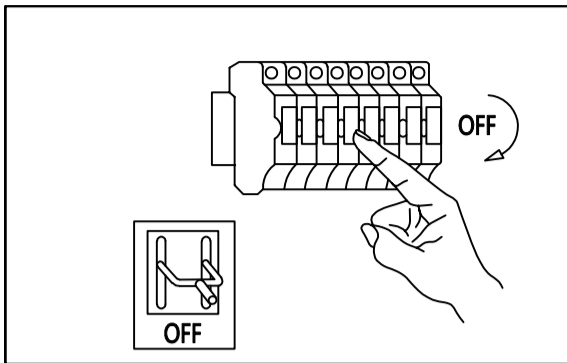

FIXTURE ASSEMBLY STEPS:

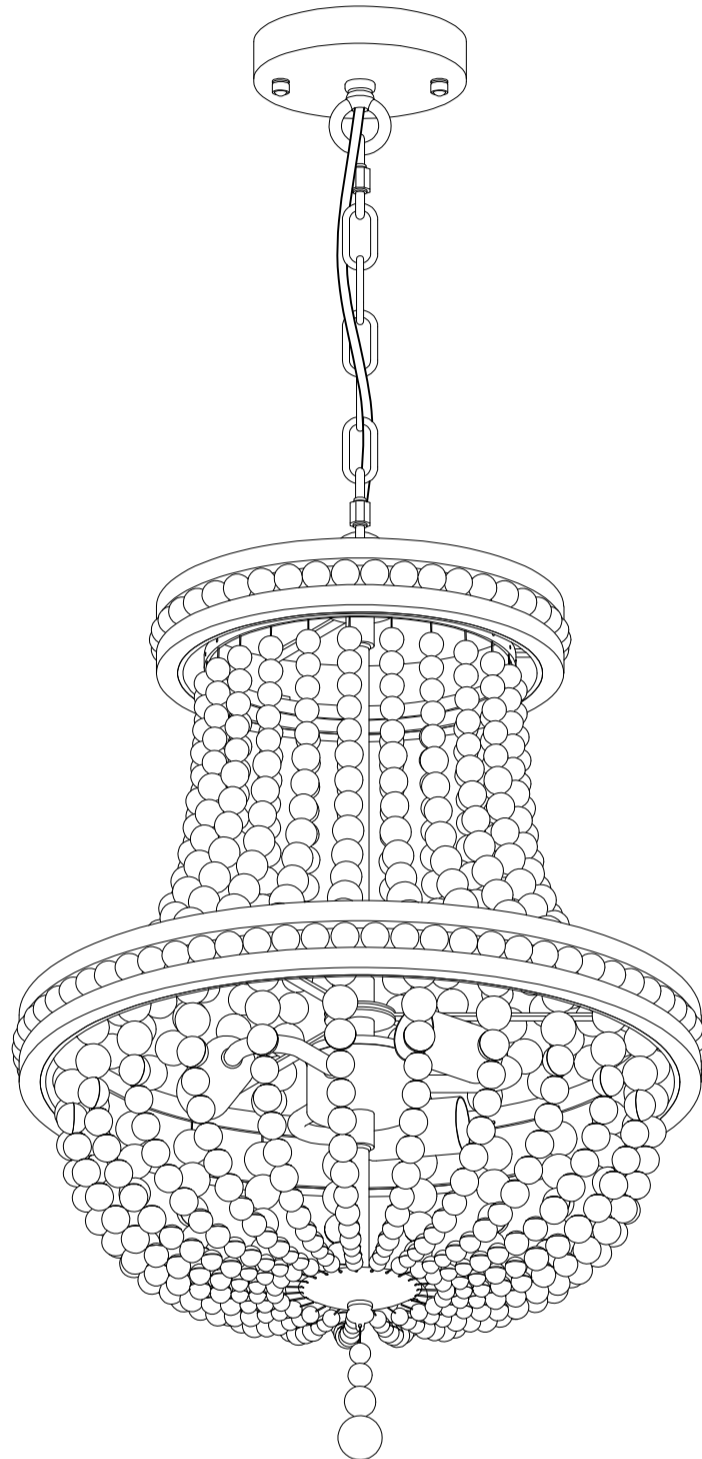

220-240V / 50Hz
 E14 3*MAX 60W TYPE B
 (Do not contain light bulb)

1. AC220~240V,50Hz.The Max lamps power is 60W TYPE B Bulb.
2. Avoid to scratch the surface of lighting and the wires when install it.
3. Connect the live wire with the L wire (L) ,Connect the netural wire to the N wire(N) ,Yellow-green wire to grounding wire (⊕) (L-L,N-N,⊕-⊕)
4. Don't install it to the ceiling before it's completely dry, the surrounding around must be ventilated and dry.
5. Keep away from the acid, basicity objects and gases, clean with soft cloth, water washing is not allowed.
6. The lighting must be installed by professional electrician and used indoor only.
7. Please keep attention to cut off the power supply when installing, cleaning, and replacing bulb.