

ASSEMBLY INSTRUCTIONS

Description: BARSTOOL WITH BACK









Important safety instructions:

- Please read carefully all instructions before assembly.
- For your safety and ease, assembly by two or more adults is recommended.
- Keep instructions for future use.







Pre-assembly:

- Do not discard any content until assembly is complete to avoid accidentally discarding small parts or hardware.
- Take out all parts and hardware from box.

Parts List

Item	Description	QTY
P1	Leg Frames 	2
P2	Back Rest 	1
P3	Seat Panel 	1
P4	Seat Front Rail 	1
P5	Seat Back Rail 	1
P6	Front Stretcher 	1
P7	Back Stretcher 	1
P8	Stretcher Frame 	1
P9	Metal Support Bar 	1

Hardware List





Item	Description	QTY
H1	Bolts Ø5/16"x50mm 	6
H2	Bolts Ø5/16"x35mm 	4
H3	Bolts Ø5/16"x25mm 	16
H4	Lock Washers Ø5/16" 	26
H5	Flat Washers Ø5/16"x19mm 	26
H6	Allen Key 4mm 	1

DISCLAIMER:

WHEN PROPERLY ASSEMBLED, THIS ITEM IS SAFE FOR INTENDED USE. SELLER IS NOT LIABLE FOR ANY DAMAGES RESULTING FROM ITEM BEING IMPROPERLY ASSEMBLED AFTER PURCHASE.



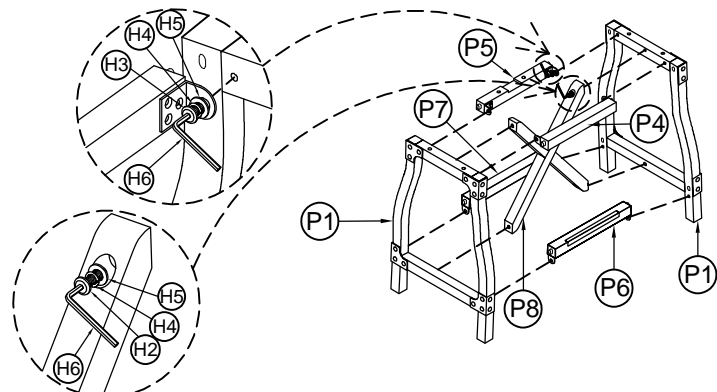

Assembly Procedures:

Step 1: Assemble the barstool with back on a flat, soft surface such as a carpet or cloth to prevent scratching the finish. Attach the Leg Frames (P1) to Seat Front Rail (P4), Seat Back Rail (P5), Front Stretcher (P6), Back Stretcher (P7) and Stretcher Frame (P8) as shown below. Don't tighten all bolts.

- (H2)x4 Bolts Ø5/16"x35mm 
- (H3)x8 Bolts Ø5/16"x25mm 
- (H4)x12 Lock Washers Ø5/16" 
- (H5)x12 Flat Washers Ø5/16"x19mm 
- (H6)x1 Allen Key 4mm 





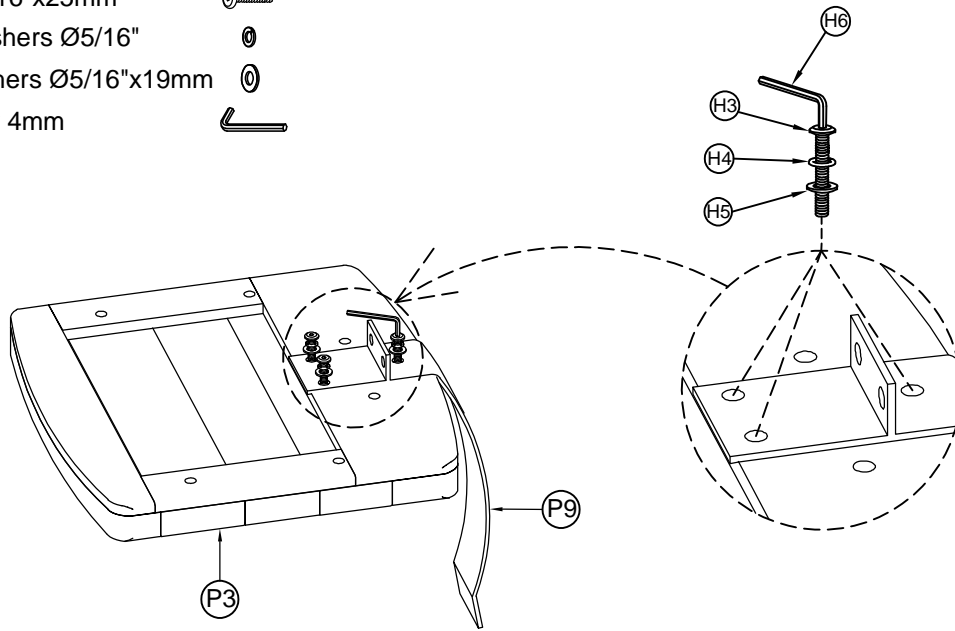

Step 2: Attach Metal Support Bar (P9) to Seat Panel (P3) as shown below. Don't tighten all bolts.

- (H3)x3 Bolts Ø5/16"x25mm 
- (H4)x3 Lock Washers Ø5/16" 
- (H5)x3 Flat Washers Ø5/16"x19mm 
- (H6)x1 Allen Key 4mm 





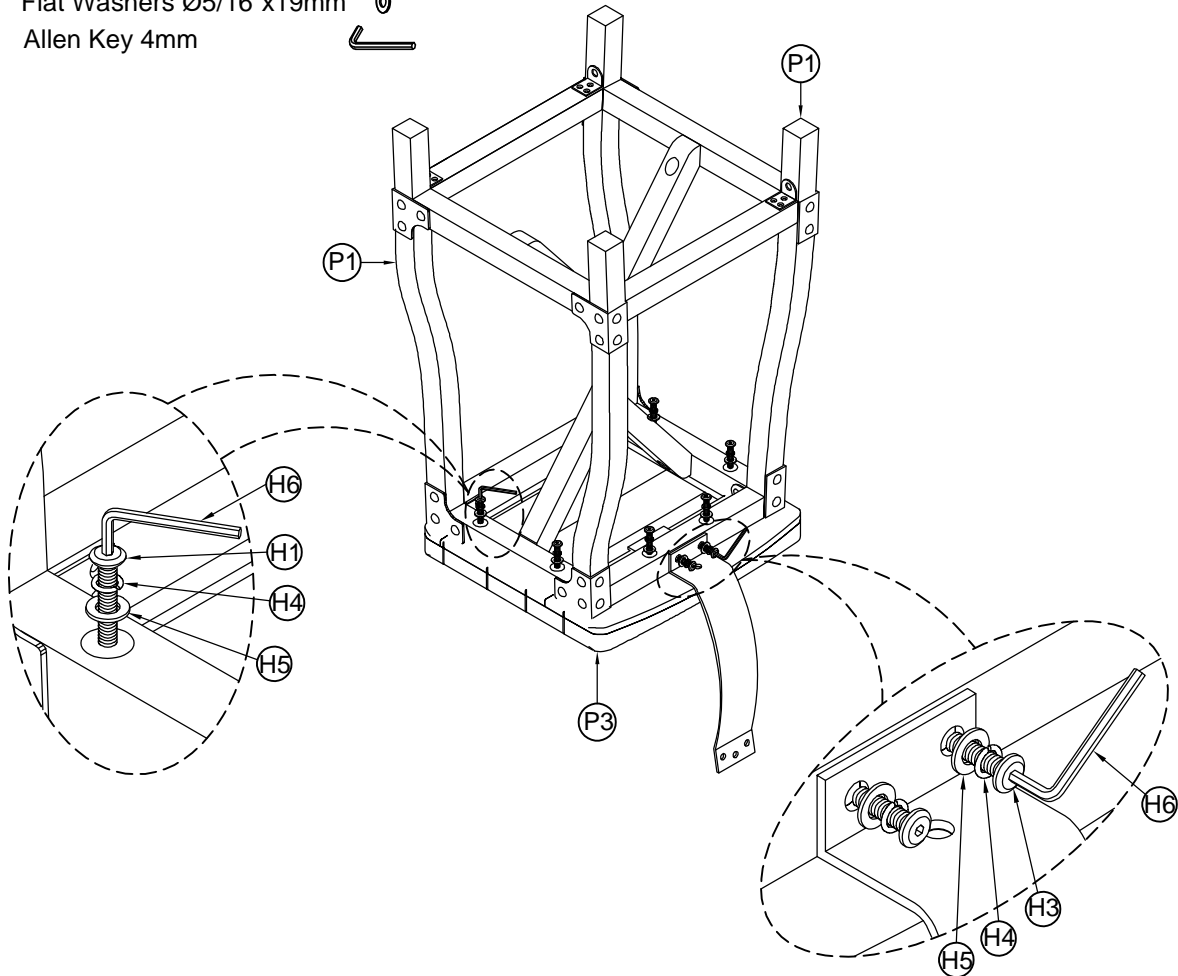

Step 3: Attach the assembled Leg frame to Seat Panel (P3) as shown below. Then tighten all bolts.

- (H1)x6 Bolts Ø5/16"x50mm 
- (H3)x2 Bolts Ø5/16"x25mm 
- (H4)x8 Lock Washers Ø5/16" 
- (H5)x8 Flat Washers Ø5/16"x19mm 
- (H6)x1 Allen Key 4mm 



Step 4: Attach the Back Rest (P2) to Metal Support Bar (P9) as shown below.

- (H3)x3 Bolts Ø5/16"x25mm 
- (H4)x3 Lock Washers Ø5/16" 
- (H5)x3 Flat Washers Ø5/16"x19mm 
- (H6)x1 Allen Key 4mm 

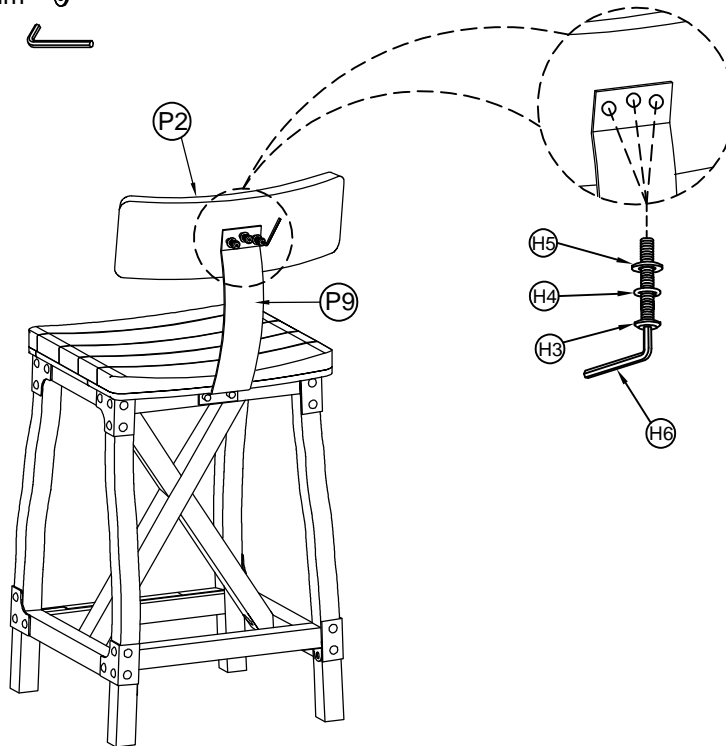

Step 5: Turn the assembled barstool to an upright position. Assembly is completed.

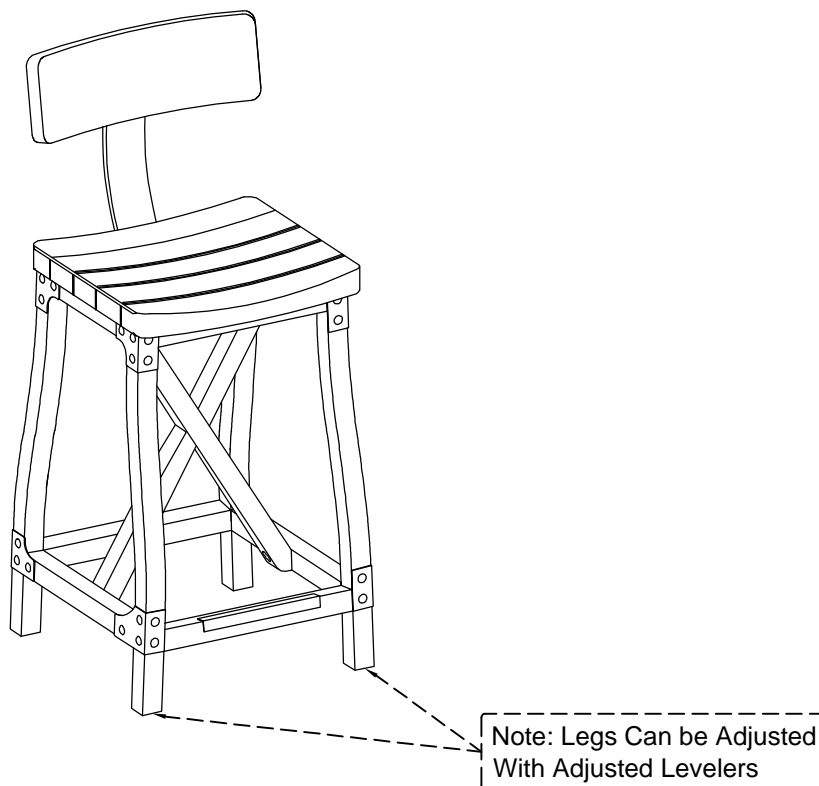

ADDITIONAL NOTE ABOUT SAFETY:
BOLTS MAY LOOSEN DURING NORMAL EVERYDAY USE.
THEY SHOULD BE INSPECTED AT LEAST EVERY 3 MONTHS AND RE-TIGHTENED AS NEEDED TO PREVENT DAMAGE OR INJURY,
AND ENSURE STABILITY.

Thank you for your purchase