



Dryer

User manual

DVE(G)50BG8300*/DVE(G)45B6300*

SAMSUNG

Contents

Safety information	4
What you need to know about the safety instructions	4
Important safety symbols	4
CALIFORNIA PROPOSITION 65 WARNING	7
Important safety precautions	8
Warnings	9
Cautions	9
Regulatory notice	11
FCC Notice	11
IC Notice	12
Open Source Announcement	13
Installation requirements	14
Key installation requirements	14
Location considerations	14
Ducting requirements	19
Exhausting requirements	20
Gas requirements	21
Electrical requirements	22
Installation	25
What's included	25
Step-by-step installation	27
Vent blockage test	33
Exhaust ducting guide	36
Door reversal	36
Before you start	39
Sort and load	39
Functional prerequisite	39

Operations	40
Control panel	40
Simple steps to start	44
Cycle overview	45
Cycle chart	47
Drying guide	49
Special features	50
SmartThings	52
Maintenance	53
Vent sensor	53
Cleaning	54
Troubleshooting	55
Checkpoints	55
Information codes	58
Specifications	59
Fabric care chart	59
Protecting the environment	60
Specification sheet	60



Safety information

Congratulations on your new Samsung dryer. This manual contains important information on the installation, use and care of your appliance. Please take some time to read this manual to take full advantage of your dryer's many benefits and features.

What you need to know about the safety instructions

Please read this manual thoroughly to ensure that you know how to safely and efficiently operate the extensive features and functions of your new appliance. Please store the manual in a safe location close to the appliance for future reference. Use this appliance only for its intended purpose as described in this instruction manual.

Warnings and Important Safety Instructions in this manual do not cover all possible conditions and situations that may occur. It is your responsibility to use common sense, caution and care when installing, maintaining and operating your dryer.

Because the following operating instructions cover various models, the characteristics of your dryer may differ slightly from those described in this manual and not all warning signs may be applicable. If you have any questions or concerns, contact your nearest service center or find help and information online at www.samsung.com.

Important safety symbols

What the icons and signs in this user manual mean:

WARNING

Hazards or unsafe practices that may result in severe personal injury, death and/or property damage.

CAUTION

Hazards or unsafe practices that may result in personal injury and/or property damage.

NOTE

Indicates that a risk of personal injury or material damage exists.

These warning signs are here to prevent injury to yourself and others.

Please follow them explicitly.

After reading this manual, store it in a safe place for future reference.

Read all instructions before using the appliance.

As with any equipment that uses electricity and moving parts, potential hazards exist. To safely operate this appliance, familiarize yourself with its operation and exercise care when using it.

SAVE THESE INSTRUCTIONS



 **WARNING - Risk of Fire**

- Clothes dryer installation must be performed by a qualified installer.
- Install the clothes dryer according to the manufacturer's instructions and local codes.
- Do not install a clothes dryer with flexible plastic venting materials. If flexible metal (foil type) duct is installed, it must be of a specific type identified by the appliance manufacturer as suitable for use with clothes dryers. Flexible venting materials are known to collapse, be easily crushed, and trap lint. These conditions will obstruct clothes dryer airflow and increase the risk of fire.
- Do not install a booster fan in the exhaust duct.
- To reduce the risk of severe injury or death, follow all installation instructions.
- Save these instructions.

SAVE THESE INSTRUCTIONS



Safety information

WARNING - To reduce the risk of fire or explosion:

- Do not dry items that have been previously cleaned, washed, soaked, or spotted with gasoline, dry cleaning solvents, or other flammable or explosive substances. They emit vapors that could ignite or explode. Any material that has been in contact with a cleaning solvent or flammable liquids or solids should not be placed in the dryer until all traces of these flammable liquids or solids and their fumes have been removed. There are many highly flammable items used in homes, such as acetone, denatured alcohol, gasoline, kerosene, some liquid household cleaners, some spot removers, turpentine, waxes, and wax removers.
- Items containing foam rubber (which may be labeled latex foam) or similarly textured rubberlike materials must not be dried on a heat setting. Heated foam rubber materials can, under certain circumstances, ignite spontaneously.

WARNING - Fire or explosion hazard

- Failure to follow safety warnings exactly could result in serious injury, death or property damage.
- Do not store or use gasoline or other flammable vapors and liquids near this or any other appliance.
- Installation and service must be performed by a qualified installer, service agency, or the gas supplier.
- Do not install a booster fan in the exhaust duct.

SAVE THESE INSTRUCTIONS



 **WARNING - What to do if you smell gas:**

- Do not try to light any appliance.
- Do not turn on the appliance.
- Do not touch any electrical switch.
- Do not use any phone in your building.
- Clear the room, building or area of all occupants.
- Immediately call your gas supplier from a neighbor's phone. Follow the gas supplier's instructions.
- If you cannot reach your gas supplier, call the fire department.

CALIFORNIA PROPOSITION 65 WARNING **WARNING**

Cancer and Reproductive Harm - www.P65Warnings.ca.gov.

SAVE THESE INSTRUCTIONS



Safety information

Important safety precautions

WARNING

To reduce the risk of fire, electric shock, or injury to persons when using your appliance, follow basic precautions, including the following:

1. Read all instructions before using this appliance.
2. Do not dry articles that have been previously cleaned in, washed in, soaked in, or spotted with gasoline, dry-cleaning solvents, or other flammable or explosive substances, as they give off vapors that could ignite or explode.
3. Do not use the dryer to dry clothes which have traces of any flammable substance, such as vegetable oil, cooking oil, machine oil, flammable chemicals, paint thinner, etc., or anything containing wax or chemicals, such as mops and cleaning cloths. Flammable substances may cause the fabric to catch fire by itself.
4. Do not store or use gasoline or other flammable vapors and liquids near this or any other appliance.
5. Do not allow children to play on or in the appliance. Close supervision of children is necessary when the appliance is used near children.
6. Before the appliance is removed from service or discarded, remove the door to the drying compartment.
7. Do not reach into the appliance if the drum is moving.
8. Do not install or store this appliance where it will be exposed to the weather.
9. Do not tamper with internal controls.
10. Do not repair or replace any part of the appliance or attempt any service unless specifically recommended in the user-maintenance instructions or in published user-repair instructions that you understand and have the skills to carry out.
11. Do not use fabric softeners or products to eliminate static unless recommended by the manufacturer of the fabric softener or product.
12. Clean the lint screen before or after each load.
13. Do not use heat to dry articles containing foam rubber or similarly textured rubber-like materials.
14. Keep area around the exhaust opening and adjacent surrounding areas free from the accumulation of lint, dust, and dirt.
15. The interior of the appliance and exhaust duct should be cleaned periodically by qualified service personnel.
16. Do not place items exposed to cooking oils in your dryer. Items contaminated with cooking oils may contribute to a chemical reaction that could cause a load to catch fire. To reduce the risk of fire due to contaminated loads, the final part of a tumble dryer cycle occurs without heat (cool down period). Avoid stopping a tumble dryer before the end of the drying cycle unless all items are quickly removed and spread out so that the heat is dissipated.
17. This appliance must be grounded. See “**Electrical requirements**” and “**Grounding**” in “**Installation**” section.

SAVE THESE INSTRUCTIONS



-
18. Do not allow children to play on or in the appliance. Close supervision of children is necessary when the appliance is used near children.
 19. Do not insert your hand under the dryer.
 - This may result in injury.
 20. Take care that children's fingers are not caught in the door when closing it.
 - This may result in injury.
 21. The control board and inlet valve are intentionally not grounded and may present a risk of electric shock only during servicing.
 - Do not contact these parts while the appliance is energized.

Warnings

WARNING

- Ensure pockets are free of small, irregularly shaped hard objects and foreign material, i.e. coins, knives, pins, etc. These objects could damage your dryer.
- Gas leaks may occur in your system, resulting in a dangerous situation.

Cautions

CAUTION

- Do not allow children or pets to play on, in, or in front of the appliance. Close supervision is necessary when the appliance is used near children and pets.
- Before discarding or removing your dryer from service, remove the door to the drying compartment to prevent children or animals from becoming trapped inside.
- Do not reach into the appliance when the drum is moving.
- Do not install or store this appliance where it will be exposed to the weather.
- Do not tamper with the controls.
- Do not repair, replace, or attempt to service any part of the appliance unless specifically instructed to in the user-repair instructions and you have the understanding and skills to carry out the procedure.
- Do not use fabric softeners or products to eliminate static unless the softener or product is recommended for dryer use by the manufacturer of the fabric softener or product.
- Clean the lint screen before or after each load.
- Keep the area around the exhaust opening and surrounding areas free from lint, dust, and dirt.
- The interior of the dryer and exhaust duct should be cleaned periodically by qualified service personnel.
- This appliance must be properly grounded. Never plug the power cord into a receptacle that is not grounded adequately or not in accordance with local and national codes. See the installation instructions for information about grounding this appliance.
- Do not sit on top of the dryer.
- Do not dry clothing with large buckles, buttons, or other heavy metal or solid objects.
- Gas leaks may not be detected by smell alone.

SAVE THESE INSTRUCTIONS



Safety information

- Gas suppliers recommend you purchase and install a UL-approved gas detector.
- Install and use in accordance with the manufacturer's instructions.
- Do not place items in your dryer that have been spotted or soaked with vegetable oil or cooking oil. Even after being washed, these items may contain significant amounts of these oils.
- Residual oil on clothing can ignite spontaneously. The potential for spontaneous combustion increases when items containing vegetable oil or cooking oil are exposed to heat. Heat sources such as your dryer can warm these items, allowing an oxidation reaction in the oil to occur. Oxidation creates heat. If this heat cannot escape, the items can become hot enough to catch fire. Piling, stacking, or storing these kinds of items may prevent heat from escaping and can create a fire hazard.
- All washed and unwashed fabrics that contain vegetable oil or cooking oil can be dangerous. Washing these items in hot water with extra detergent will reduce, but not eliminate, the hazard. Always use the Cool Down cycle for these items to reduce their temperature. Never remove these items from the dryer hot or interrupt the drying cycle until the items have run through the Cool Down cycle. Never pile or stack these items when they are hot.



SAVE THESE INSTRUCTIONS



Regulatory notice

FCC Notice

CAUTION

Any changes or modifications not expressly approved by the party responsible for compliance could void the user's authority to operate the equipment.

This device complies with Part 15 of FCC Rules. Operation is Subject to following two conditions:

1. This device may not cause harmful interference, and
2. This device must accept any interference received including interference that cause undesired operation.

For products sold in the US and Canadian markets, only channels 1–11 are available. You cannot select any other channels.

FCC STATEMENT:

This equipment has been tested and found to comply within the limits for a Class B digital device, pursuant to part 15 of the FCC Rules. These limits are designed to provide reasonable protection against harmful interference in a residential installation.

This equipment generates, uses, and can radiate radio frequency energy and, if not installed and used in accordance with the instructions, may cause harmful interference to radio communications. However, there is no guarantee that interference will not occur in a particular installation. If this equipment does cause harmful interference to radio or television reception, which can be determined by turning the equipment off and on, the user is encouraged to try to correct the interference by one or more of the following measures:

- Reorienting or relocating the receiving antenna
- Increasing the separation between the equipment and receiver
- Connecting the equipment to an outlet that is on a different circuit than the radio or TV.
- Consulting the dealer or an experienced radio/TV technician for help.

FCC RADIATION EXPOSURE STATEMENT:

This equipment complies with FCC radiation exposure limits set forth for an uncontrolled environment. This equipment should be installed and operated so there is at least 8 inches (20 cm) between the radiator and your body. This device and its antenna(s) must not be colocated or operated in conjunction with any other antenna or transmitter.

SAVE THESE INSTRUCTIONS



Regulatory notice

English

Unintentional emitter per FCC Part 15
Product type : Clothes Dryers
Model : DVE(G)50BG8300*/DVE(G)45B6300*
Responsible Party – U.S. Contact Information
Samsung Electronics America, Inc.
QA Lab America
19 Chapin Rd. Building D Pine Brook NJ 07058
Tel: 1-973-808-6375 Fax: 1-973-808-63

IC Notice

The term “IC” before the radio certification number only signifies that Industry Canada technical specifications were met. Operation is subject to the following two conditions:

1. This device may not cause interference, and
2. This device must accept any interference, including interference that may cause undesired operation of the device.

This Class B digital apparatus complies with Canadian ICES-003.

Cet appareil numérique de la classe B est conforme à la norme NMB-003 du Canada.

For products sold in the US and Canadian markets, only channels 1–11 are available. You cannot select any other channels.

IC RADIATION EXPOSURE STATEMENT:

This equipment complies with IC RSS-102 radiation exposure limits set forth for an uncontrolled environment. This equipment should be installed and operated so there is at least 8 inches (20 cm) between the radiator and your body. This device and its antenna(s) must not be colocated or operated in conjunction with any other antenna or transmitter.

SAVE THESE INSTRUCTIONS



Open Source Announcement

The software included in this product contains open source software. You may obtain the complete corresponding source code for a period of three years after the last shipment of this product by sending an email to <mailto:oss.request@samsung.com>.

It is also possible to obtain the complete corresponding source code in a physical medium such as a CD-ROM; a minimal charge will be required.

The following URL http://opensource.samsung.com/opensource/SMART_AT_051/seq/0 leads to the download page of the source code made available and open source license information as related to this product. This offer is valid to anyone in receipt of this information.



NOTE

Hereby, Samsung Electronics, declares that the radio equipment type appliance is in compliance with Directive 2014/53/EU. The full text of the EU declaration of conformity is available at the following internet address: The official Declaration of conformity may be found at <http://www.samsung.com>, go to Support > Search Product Support and enter the model name.

Wi-Fi max transmitter power : 20 dBm at 2.412 GHz – 2.472 GHz

SAVE THESE INSTRUCTIONS



Installation requirements

Read through the following instructions before installing the dryer and keep this manual for future reference.

WARNING

Certain internal parts are intentionally not grounded and may present a risk of electric shock only during servicing.

Service Personnel - Do not contact the following parts while the appliance is energized: Control board and inlet valve.

Key installation requirements

- A grounded electrical outlet.
- A power cord for electric dryers (except in Canada).
- Gas lines (for gas models) that must meet national and local regulations.
- An exhaust system made of rigid metal or flexible stiff-walled metal exhaust ducting.

WARNING

Remove the door from all discarded appliances to prevent a child from suffocating.

Location considerations

The dryer should be located where there is enough space at the front for loading the dryer, and enough space behind for the exhaust system. This dryer is factory-ready for the rear exhaust option. To exhaust out the bottom, right or the left, use the accessory exhaust kit. Instructions are included with the kit. Make sure the room in which the dryer is located has enough fresh air. The dryer must be located where there are no air-flow obstructions. For gas dryers, adequate clearance must be maintained as noted on the data plate to ensure adequate air for combustion and the proper dryer operation.

The dryer must not be installed or stored in an area where it will be exposed to water and/or weather. The dryer area must be kept clear of combustible materials, gasoline, and other flammable vapors and liquids. A dryer produces combustible lint. The area around the dryer should be kept lint-free.



Dimensions

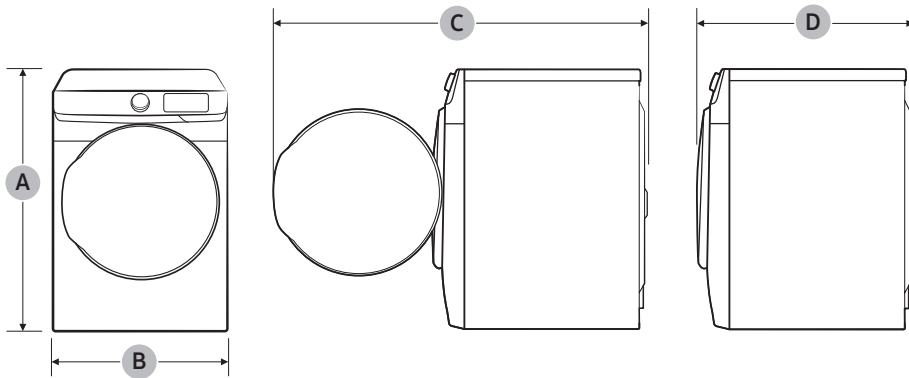

	Type	Front loading dryer
Dimensions (in. (mm))	A. Overall height	38.7 (984)
	B. Width	27.0 (686)
	C. Depth with door open	DVE(G)50BG8300* : 53.1 (1348) DVE(G)45B6300* : 52.9 (1344)
	D. Depth	DVE(G)50BG8300* : 31.4 (798) DVE(G)45B6300* : 31.3 (794)



Installation requirements

Clearance requirement

This clearance requirement is applicable for dryers only.

NOTE

- For washer's clearance requirement, see the washer's user manual.
- If the washer and dryer have different clearance requirements, use the one with the larger value.

Alcove or closet installations

WARNING

- The dryer must be exhausted to the outside to reduce the risk of fire when installed in an alcove or closet.
- No other fuel-burning appliance should be installed in the same closet as the dryer.
- Place the dryer at least 18 in. (460 mm) above the floor for garage installation.

Minimum clearance for stable operation:

Sides	Top	Rear	Front
1 in. (25 mm)	1 in. (25 mm)	4 in. (102 mm)	1 in. (25 mm)

If both the washer and a dryer are installed in the same location, the front of the alcove or closet must have two unobstructed air openings for a combined minimum total area of 72 in.² (465 cm²).



Undercounter installation

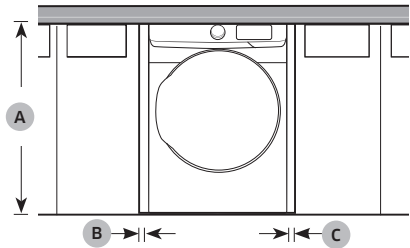

A	39.6 in. (1006 mm)
B	1 in. (25 mm)
C	1 in. (25 mm)

Pedestal installation

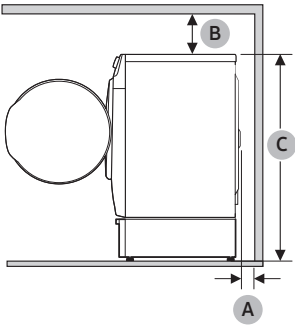

A	4 in. (102 mm)
B	6 in. (152 mm)
C	52.8 in. (1341 mm)



Installation requirements

This clearance requirement is applicable for washer and dryer pair installation.

Side by side installation

Stacked installation (Model: SKK-8K)

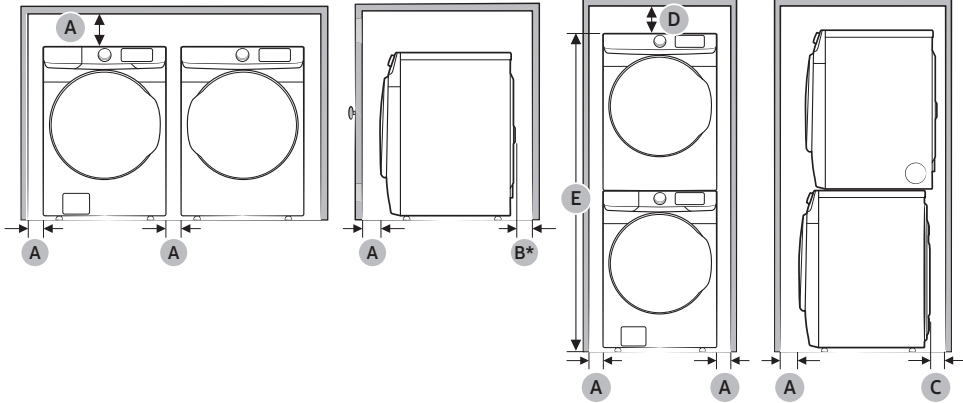

Models	DVE(G)50BG8300*	DVE(G)45B6300*
A	1 in. (25 mm)	
B*	4 in. (102 mm)	
C	4.6 in. (117 mm)	5.1 in. (129 mm)
D	6 in. (152 mm)	
E	78.5 in. (1994 mm)	

(B*): This clearance requirement only applies to the dryer. For washer's clearance requirement, see the washer's user manual.

Minimum space **(B*)** of 4" is required for best dryer performance. In case of insufficient space for duct installation, properly sized vent kit is needed.

NOTE

Stacking (MODEL NO: SKK-8K)

Many of Samsung's washers and dryers can be stacked to maximize usable space. You can purchase an optional stacking kit from your Samsung retailer. For details about stacking and compatible models, refer to the user manual included in the stacking kit you purchase.

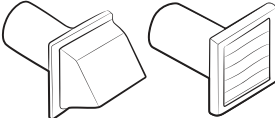
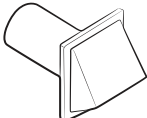

Ducting requirements

Weather hood type	Recommended	Use only for short-run installation
	 <p>4" (10.2 cm)</p>	 <p>2.5" (6.4 cm)</p>
No. of 90° elbows	Rigid	Rigid
0	80 ft. (24.4 m)	74 ft. (22.6 m)
1	68 ft. (20.7 m)	62 ft. (18.9 m)
2	57 ft. (17.4 m)	51 ft. (15.5 m)
3	47 ft. (14.3 m)	41 ft. (12.5 m)

NOTE

* Use a 4-inch (10.2 cm) diameter rigid aluminum or galvanized steel duct.

If you integrate the dryer’s vent system with an existing exhaust system:

- Make sure the exhaust system meets all applicable local, state, and national regulations.
- Verify you are not using flexible plastic duct.
- Make sure to check for and remove all lint buildup from inside the existing ducts.
- Confirm the duct is not kinked or crushed.
- Make sure the exhaust hood damper opens and closes freely.

Manometer measurements

The static pressure in any exhaust system must not exceed 0.83 inches of water column or be less than 0. Note that these values are measured with the dryer running with a manometer presented to the exhaust duct that connects to the dryer. The dryer tumbler must be empty and lint filter clean.



Installation requirements

Exhausting requirements

The dryer must not be exhausted into a chimney, a wall, a ceiling, an attic, a crawl space, or a concealed space of a building. Exhausting the dryer to the outside will prevent large amounts of lint and moisture from being blown into the room.

In the United States and Canada

- All dryers must be exhausted to the outside.
- The required exhaust duct is 4 inches (10.2 cm) in diameter.
- See “**Ducting requirements**” in the “**Installation**” section for the maximum duct length and number of bends that can be used.
- The total length of flexible metal duct must not exceed 7’10 1/2” (2.4 m).
- Do not assemble the duct with screws or other fasteners that extend into the duct and catch lint.
- **For the United States only:** Use only those foil-type flexible ducts, if any, specifically identified for use with the appliance by the manufacturer and that comply with the Outline for Clothes Dryer Transition Duct. Use Subject 2158A.

Outside the United States and Canada

- Refer to the local codes.

WARNING

- You must exhaust the dryer to the outside to reduce the risk of fire when you install the dryer in an alcove or closet.
- Do not use a plastic or non-metal flexible duct.
- If your existing ductwork is plastic, non-metal, or combustible, replace it with metal.
- Use only a metal exhaust duct that is non-flammable to ensure containment of exhaust air, heat, and lint.



Gas requirements

WARNING

- Use only natural or LP (liquid propane) gases.
- The installation must be conformed with local codes, or in the absence of local codes, with the national fuel gas code, ANSI Z223.1/NFPA 54, latest revision (for the UNITED STATES), or with the natural gas and propane installation code, CSA B149.1 (for Canada).
- Gas dryers are equipped with a burner vent for use with natural gas. If you plan to use your dryer with LP (liquid propane) gas, it must be converted for safe and proper performance by a qualified service technician. **(LNG models only)**

You must check the burner of your model and use the proper LP Kit accordingly. To check the detail information of the burner, open the door and check the rating label location on the door frame.

- 20,000 BTU: LPKIT-4/XAA (DC98-04114A)
- 22,000 BTU: LPKIT-3/XAA (DC99-00792A)
- A 1/2" (1.27 cm) gas supply line is recommended and must be reduced to connect to the 3/8" (1 cm) gas line on your dryer. The National Fuel Gas Code requires that an accessible, approved manual gas shut-off valve be installed within 6" of your dryer.
- Gas dryers installed in residential garages must be raised 18 inches (46 cm) above the floor.
- Additionally, a 1/8" (0.3 cm) N.P.T. (National Pipe Thread) plugged tapping, accessible for test gauge connection, must be installed immediately upstream of your dryer's gas supply connection.
- Your dryer must be disconnected from the gas supply pipe system during any pressure testing of the system.
- Do not reuse old flexible metal gas lines. Flexible gas lines must be designed and certified by the standard for connectors for Gas Appliances, ANSI Z21.24 • CSA 6.10.

NOTE

- Your dryer uses an automatic ignition system to ignite the burner. There is no constant burning pilot.
- Any pipe joint compound used must be resistant to the action of any liquefied petroleum gas.
- As a courtesy, most local gas utilities will inspect a gas appliance installation.

Installation requirements

Commonwealth of Massachusetts installation instructions

Your dryer must be installed by a licensed plumber or gas fitter. A “T” handle manual gas valve must be installed in the gas supply line to your dryer. If a flexible gas connector is used to install your dryer, the connector can be no longer than 3’ (36”).

WARNING

- Gas leaks may occur in your system, creating a dangerous situation.
- Gas leaks may not be detected by smell alone.
- Gas suppliers recommend you purchase and install a UL-approved gas detector.
- Install and use in accordance with the manufacturer’s instructions.

Electrical requirements

The wiring diagram is located on the plate under the control panel or rear frame.

WARNING

- Improperly connecting the equipment grounding conductor can result in a risk of electric shock. Check with a qualified electrician or serviceman if you are in doubt as to whether your dryer is properly grounded. Do not modify the plug provided with your dryer – if it doesn’t fit the outlet, have a proper outlet installed by a qualified electrician.
- To prevent unnecessary risk of fire, electrical shock, or personal injury, all wiring and grounding must be done in accordance with local codes, or in the absence of local codes, in accordance with the National Electrical Code, ANSI/NFPA No. 70-Latest Revision (for the U.S.) or the Canadian Electrical Code CSA C22.1 – Latest Revisions and local codes and ordinances. It is your responsibility to provide adequate electrical service for your dryer.
- All gas installations must be done in accordance with the national Fuel Code ANSI/Z2231 – Latest Revision (for the U.S.) or CAN/CGA – B149 Installation Codes – Latest Revision (for Canada) and local codes and ordinances.

Grounding

This dryer must be grounded. In the event of a malfunction or breakdown, the ground will reduce the risk of electrical shock by providing a path of least resistance for the electrical current.

Gas models

WARNING

- Your dryer has a cord with an equipment-grounding conductor and a grounding plug. The plug must be plugged into an appropriate outlet that is properly installed and grounded in accordance with all local codes and ordinances.
- Do not modify the plug provided with your dryer – if it doesn't fit the outlet, have a proper outlet installed by a qualified electrician.
- Do not connect the ground wire to plastic plumbing lines, gas lines, or hot water pipes.

Electric models

WARNING

- Your dryer has an optional cord with an equipment-grounding conductor and a grounding plug. This cord is sold separately.
- The plug must be plugged into an appropriate outlet that is properly installed and grounded in accordance with all local codes and ordinances.
- Do not modify the plug provided with your dryer – if it doesn't fit the outlet, have a proper outlet installed by a qualified electrician.
- If a power cord is not used and the electric dryer is to be permanently wired, the dryer must be connected to a permanently grounded metal wiring system, or an equipment grounding conductor must be run with the circuit conductors and connected to the equipment grounding terminal or lead on the dryer.



Installation requirements

Electrical connections

Before operating or testing, follow all grounding instructions in the “**Grounding**” section. An individual branch (or separate) circuit serving only your dryer is recommended.

Do not use an extension cord.

Gas models – U.S. and Canada

A 120 volt, 60 Hz AC approved electrical service with a 15-ampere fuse or circuit breaker is required.

Electric models – U.S. only

Most U.S. dryers require a 120 / 240 volt, 60 Hz AC approved electrical service. Some require 120 / 208 volt, 60 Hz approved electrical service. The electric service requirements can be found on the data label located behind the door. A 30-ampere fuse or circuit breaker on both sides of the line is required.

- If a power cord is used, the cord should be plugged into a 30-ampere receptacle.
- The power cord is not provided with U.S. electric model dryers. This cord is sold separately.

Risk of Electric Shock

WARNING

When local codes allow, you can connect the dryer’s electrical supply with a new power supply cord kit, marked for use with a dryer, that is U.L. listed and rated at a minimum of 120 / 240 volts, 30-amperes with three No. 10 copper wire conductors terminated with closed loop terminals, open-end spade lugs with turned up ends, or with tinned leads.

- Do not reuse a power supply cord from an old dryer. The power cord electric supply wiring must be supported at the dryer cabinet by a suitable UL-listed strain relief.
- Grounding through the neutral conductor is prohibited for (1) new branch-circuit installations, (2) mobile homes, (3) recreational vehicles, and (4) areas where local codes prohibit grounding through the neutral conductor. (Use a 4-prong plug for a 4 wire receptacle, NEMA type 14-30R.)

Electric models – Canada Only

A 120 / 240 volt, 60 Hz AC approved electrical service fused through a 30-ampere fuse or circuit breaker on both sides of the line is required.

NOTE

All Canadian models are shipped with the power cord attached. The power cord should be plugged into a 30-ampere receptacle. In Canada, you may convert a dryer to 120 / 208 volts.



Installation

This dryer must be installed by a qualified technician. The installer is responsible for connecting the dryer to the main power while observing the relevant safety regulations of your area.

What's included

Make sure all the parts are included in the product package. If you have a problem with the dryer or the parts, contact a local Samsung customer center or the retailer.

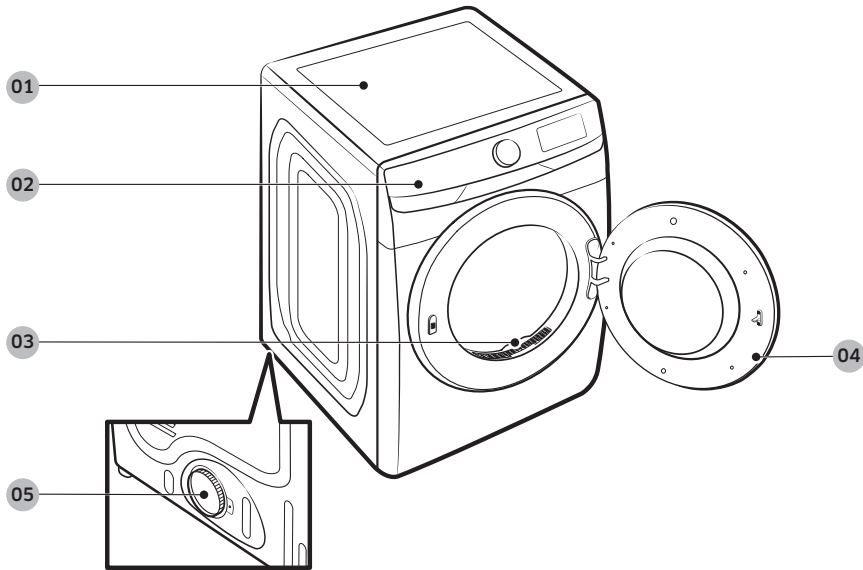

01 Worktop

02 Control panel

03 Lint filter

04 Door

05 Exhaust duct



Installation

English

Parts supplied



Y-connector



Water hose (Canadian elec. models only)



Short water hose

Tools needed for installation



Pliers

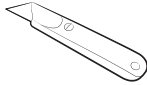

Cutting knife



Pipe wrench
(gas models only)



Nut screwdriver

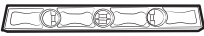

Level



Phillips screwdriver



Duct tape



Wrench



LPG-safe compound
or Teflon Tape (for gas
installation)

WARNING

Packing materials can be dangerous to children. Keep all packing materials (plastic bags, polystyrene, etc.) out of children's reach.



Step-by-step installation

Make sure you have a qualified technician install the dryer. Step by step installation instructions start below.

- Do not remove the protective film on the door before completing the product installation. If you remove the protective film before the installation is complete, the door may get scratched or damaged during installation.
- Make sure the installation location allows enough space for the dryer door to be fully open.

STEP 1 Install the exhaust system

1. Select a location and move the dryer to the site. For easy access, we recommend you install the dryer in the same location as your washer.
2. To change the door direction, see “**Door reversal**” on page 36.
3. Install the exhaust system as instructed in the “**Exhaust ducting guide**” section.

CAUTION

Before installing your dryer, remove the packing in the duct.

NOTE

- To move the dryer easily, lay two of the carton cushions from the packaging on the floor. Tip the dryer on its side so it lies across both cushion-tops. Push the dryer so that it is near its final location, and then set the dryer upright.
- Secure room around the dryer to facilitate ducting and wiring.

STEP 2 Connect the gas line (for gas models)

Before connecting the gas line, make sure you have read the “**Gas requirements**” section on page 21.

1. Remove the protective cap from the gas pipe.
2. Apply an LPG (Liquefied Petroleum Gas)-safe compound or 1.5 wraps of Teflon tape to all threaded connections.
3. Connect the gas supply to the dryer. An additional fitting is required to connect the 3/4” (1.9 cm) female thread end of a flexible connector to the 3/8” (1 cm) male threaded end on the dryer. Tighten up the fitting over all threads.
4. Turn on the gas supply, and check for any leaks using a soap solution. If a leak is found, tighten the connections and try again. Do not use an open flame to check for gas leaks.

Installation

STEP 3 Connect the electrical wiring (for electric models)

Before connecting the electrical wiring, make sure you have read the “**Electrical requirements**” section on page 22.

3-wire system

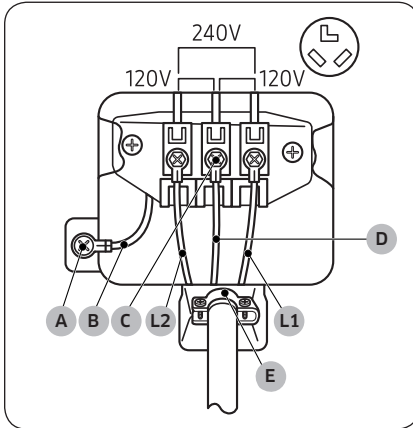

- A. External ground connector
- B. Neutral grounding wire (white)
- C. Center silver-colored terminal block screw
- D. Neutral wire (white or center wire)
- E. 3/4" (1.9 cm) UL-listed strain relief

1. Loosen or remove the screws from the center terminal block.
2. Connect the neutral wire (white or center wire) of the power cable to the center, silver-colored terminal screw of the terminal block. Tighten the screws.
3. Connect the other wires to outer terminal block screws. Tighten the screws.
4. Tighten the strain relief screws.
5. Insert the terminal block cover into the rear panel of the dryer. Then, secure the cover with a hold-down screw.

⚠ CAUTION

- To convert from the 4-wire system to 3-wire system, connect the ground strap to the terminal block support to ground the dryer frame to the neutral conductor.
- Ring-type terminals are recommended. If using strap terminals, make sure they are tightened.
- Connect the power cord and check L1/L2/N voltage. If the voltage is low, it may not heat properly. Review the “**Electrical requirements**” section on page 22 if needed.

4-wire system

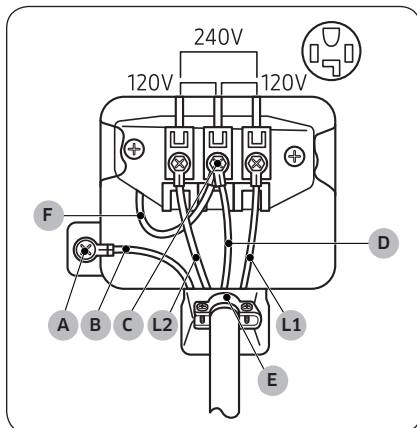

- A. External ground connector
- B. Neutral grounding wire (white)
- C. Center silver-colored terminal block screw
- D. Neutral wire (white or center wire)
- E. $\frac{3}{4}$ " (1.9 cm) UL-listed strain relief
- F. Neutral wire (white or center wire)

1. Remove the external ground connector's screw and connect the ground wire (green or unwrapped) of the power cable to the screw.

⚠ CAUTION

- To connect the ground wire to the neutral position without through contact A (cabinet ground), contact a technician. This is not user serviceable.
- Ring-type terminals are recommended. If using strap terminals, make sure they are tightened.

2. Loosen or remove the screws from the center terminal block.
3. Connect the neutral wire (white or center wire) and ground wire (white) to the center screw of the terminal block. Tighten the screw.
4. Connect the other wires to the outer terminal block screws. Tighten the screws.
5. Tighten the strain relief screws.
6. Insert the tab of the terminal block cover into the rear slot of the dryer. Secure the cover with a hold-down screw.

⚠ CAUTION

Connect the power cord and check L1/L2/N voltage. If the voltage is low, it may not heat properly. Review the "Electrical requirements" section on page 22 if needed.

⚠ WARNING

- All U.S. models are designed for a 3-wire system connection. The dryer frame is grounded to the neutral conductor at the terminal block. A 4-wire system connection is required for new or remodeled construction, mobile homes, or if local codes do not permit grounding through neutral. If you use the 4-wire system, you cannot ground the dryer frame to the neutral conductor at the terminal block.
- Remove the terminal block cover plate. Insert the power cord with a UL-listed strain relief through the hole provided in the cabinet near the terminal block.
- A strain relief must be used. Do not loosen the nuts already installed on the terminal block. Be sure they are tight. Use a $\frac{3}{8}$ " (1 cm) deep well socket.
- Since January 1, 1996, the national electric code requires that new wiring (not existing) utilize a 4-wire connection to this dryer.

Installation

STEP 4 Connect the water hose

The dryer must be connected to a cold water tap using the provided water hoses.

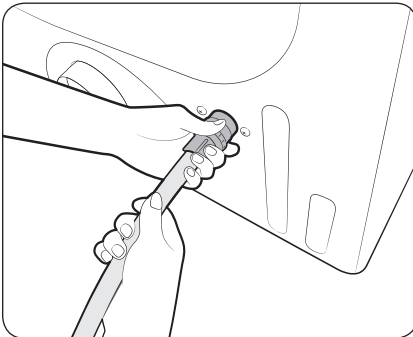
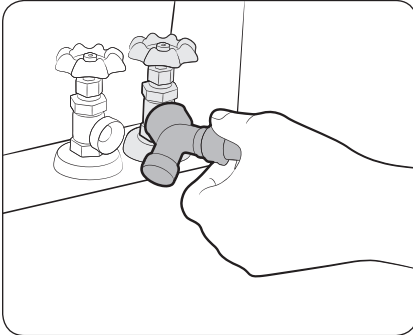

1. Close the cold water tap. If you have a washer's cold water hose attached to the cold water tap, unscrew and remove the hose. Then, connect the female end of the Y-connector to the cold water tap.
2. Connect the straight end of the water hose to the Y-connector. Tighten the hose coupling by hand.
3. Using pliers, tighten the coupling an additional two-thirds turn. Do not overtighten. You can damage the coupling.
4. Connect the angled end of the water hose to the filling valve at the bottom rear of the dryer. Turn the coupling by hand until it is tight.
5. Using pliers, tighten the coupling an additional two-thirds turn. Do not overtighten. You can damage the coupling.
6. If you detached the cold water hose from your washer, attach the hose to the open end of the Y-connector, tighten the coupling by hand until it is tight, and then, using a pliers, tighten an additional two-thirds turn.
7. Open the cold water tap, and then check for any leaks.

If the Y-connector cannot be directly connected to the cold water tap, use the short hose. See the **"Using the short hose as an extension"** section on page 31.

Using the short hose as an extension

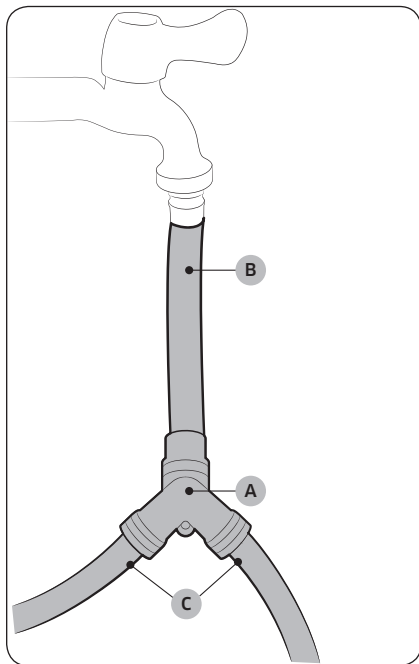

1. Close the cold water tap. If you have a washer's cold water hose attached to the cold water tap, unscrew and remove the hose. Then, connect the **short hose (B)** to the cold water tap. Turn the coupling by hand until it is tight.
2. Using pliers, tighten the coupling an additional two-thirds turn. Do not overtighten. You can damage the coupling.
3. Connect the **Y-connector (A)** to the brass male end of the short hose. Turn the coupling by hand until it is tight.
4. Using pliers, tighten the coupling an additional two-thirds turn. Do not overtighten. You can damage the coupling.
5. Connect the angled end of the **water hoses (C)** to the filling valve at the bottom rear of the dryer. Turn the coupling by hand until it is tight.
6. Using pliers, tighten the coupling an additional two-thirds turn. Do not overtighten. You can damage the coupling.
7. If you detached the cold water hose from your washer, attach the hose to the free end of the Y-connector, tighten the coupling by hand until it is tight, and then, using a pliers, tighten an additional two-thirds turn.
8. Open the cold water tap, and then check for any leaks.

Installation

STEP 5 Level the dryer

To ensure optimal performance, the dryer must be level.

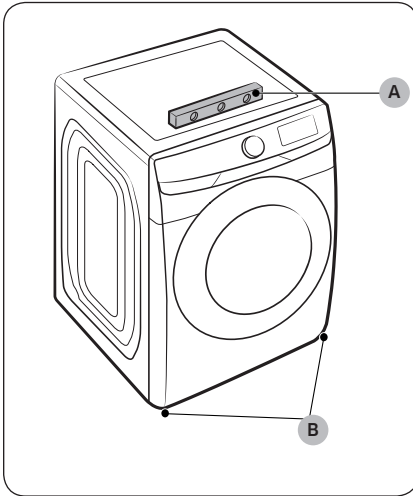

Using a **level (A)**, check if the dryer is level side to side and then front to back. If the dryer is not level, turn the **leveling feet (B)** clockwise to lower the dryer or counterclockwise to raise the dryer.

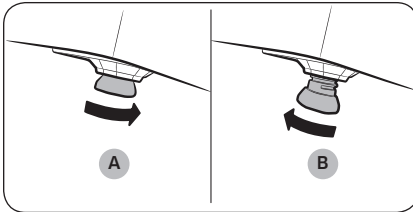

NOTE

- To set the dryer to the same height as your washer, fully **retract (A)** the leveling feet by turning them counterclockwise, then **loosen (B)** the feet by turning them clockwise. Once the dryer is the same height as the washer, follow the directions above to level the dryer.
- Adjust the leveling feet only as much as necessary to level the dryer. Extending the leveling feet more than necessary can cause the dryer to vibrate.

STEP 6 Power on (for gas models)

Make sure all gas connections, the exhaust line, and all wiring is connected correctly. Then, plug the power cord into a power source and check the dryer's installation and operation using the final checklist in Step 7 below.

STEP 7 Final Check

When installation is complete, confirm that:

- The dryer is plugged into an electrical outlet and grounded properly.
- The exhaust ductwork is connected, and the joints are taped.
- You have used rigid or stiff-walled flexible metal duct material, not plastic flexible duct.
- The dryer is level and is sitting firmly on the floor.
- The dryer starts, runs, heats, and shuts off properly.
- The gas is supplied properly with no leaks (For gas models only).

CAUTION

The burner may not ignite initially due to air in the gas line. Allowing your dryer to operate on a heat setting will purge the line. If the gas does not ignite within 5 minutes, turn your dryer off and wait 5 minutes. Be sure the gas supply to your dryer has been turned on. To confirm gas ignition, check the exhaust for heat.

Vent blockage test

After the dryer is installed, start the Vent Blockage Test to check if the duct system is properly installed. The Vent Blockage Test automatically detects the status of the ducts and reports any blockage or problems. Proper ducting can reduce drying time and save energy.

NOTE

The Vent Blockage Test must run when the dryer is cool. If the dryer warms up after the installation check, run the **AIR FLUFF** cycle for several minutes to reduce its internal temperature.



Installation

Running the vent blockage test

1. Make sure the drum is empty, and then close the door. (If there are any clothes or other items in the drum, the test will not give accurate results.)
2. Press the **Power** button to turn the dryer on, then simultaneously press and hold the **Adjust Time** \wedge and **Dryness** buttons for 3 seconds. “InS” appears in the dryer’s display. (If you have started other procedures before the Vent Blockage Test, the dryer will not enter the Vent Blockage Test mode.)
3. Press the **Start/Pause (Hold to Start)** button. The Vent Blockage Test starts immediately. During the test, the number indicator makes a circle in 6 clockwise steps. The test takes about 2 minutes. Do not open the door during the test.
4. After 2 minutes, when the test is complete, the results are displayed and the dryer sounds a tone. If status of the duct system is normal, “0” appears and the dryer sounds a completion tone. If the duct system cannot exhaust properly, the check code appears, and the dryer sounds an alarm tone. For description about the code, see the “**Installation check codes**” section on page 35.
If there are any other problems, an information code appears in the display. For description about the code, see the “**Information codes**” section on page 58.
 - To stop or cancel the Vent Blockage Test, press the **Power** button to turn off your dryer.
 - The results remain on the display for about 5 minutes and then automatically turn off. You can turn the results off immediately by pressing the **Power** button.

NOTE

- During or after the test, the internal drum is hot. Use caution to prevent burns. The Vent Blockage Test is used to check for problems in the current duct system when the dryer is installed for the first time.
- If the test result displays check code (the duct system is blocked), refer to the “**Ducting requirements**” section on page 19 and the “**Exhaust ducting guide**” section below, and then take proper measures to correct any problems. If the test is suspended, it could result in incorrect results. Follow the proper procedures when testing the dryer.
- Even if the test result is normal (“0”), the duct system could be blocked slightly. Properly install all duct work according to the installation instructions in this manual.



Installation check codes

Check code	Meaning	Solution
0	Vent condition is good.	
C1g (Cg)	The vent is clogged.	<ol style="list-style-type: none"> 1. Clean the lint filter. 2. Check your vent condition. (Refer to the “Ducting requirements” section) * You must take measures (such as cleaning) through expert personnel.
C80 (C8)	About 80 % of the vent is clogged. (This may decrease the drying performance.)	
C90 (C9)	Over 90 % of the vent is clogged. (This may lead to poor drying performance or cause malfunction)	
Ct	The internal temperature of the dryer is too low (below 32 °F (0 °C)) or too high (over 104 °F (40 °C)) and therefore vent blockage cannot be detected.	Leave the dryer at room temperature (41~95 °F (5~35 °C)) for an hour and check again.
tC	Temperature sensor error	Contact a service center.
C1	Unit is detecting items inside the drum or there is an error on the dry sensor.	Remove items from the drum and check again. If the problem continues, contact a service center.
dC	Unit is detecting door is open	Close the door properly and check again. If the problem continues, contact a service center.
9C1	Abnormal voltage detected	Check the power connection. (Refer to the “ Connect the electrical wiring (for electric models) ” section) If the problem continues, contact a service center.
HC	Detection of abnormal temperature in drum.	Check the power connection. Check the vent condition if the problem continue, contact a service center.



Installation

Exhaust ducting guide

Ducting

1. Make sure the dryer is installed properly so the air exhausts freely.
2. Use 4-inch rigid metal ducts. Tape all joints including the dryer connection. Never use lint-trapping screws.
3. To facilitate the exhaust, keep the ducts as straight as possible.

Cleaning

Clean all old ducts before installing the dryer, and make sure the vent flap opens and closes freely. We recommend that you clean the exhaust system annually or on a regular basis.

WARNING

- To prevent fire, do not use plastic, thin-foil, or non-metal flexible ducts of any kind.
- Do not use a poor exhaust system because it slows down the dryer's performance.
- Do not use excessively long ducts that have multiple elbows.
- Do not use crushed or clogged venting or ducts.

Door reversal

Type 1

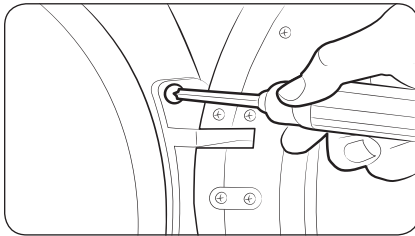

1. Put a soft rug on the floor to rest the door on after you have removed it. This will prevent the door from being scratched.
2. Unplug the power cord.
3. Remove two door hinge screws.
4. Lift the door and remove it.

NOTE

There is a screw on the back side of the hinge that will support the door as you unscrew the hinge screws.

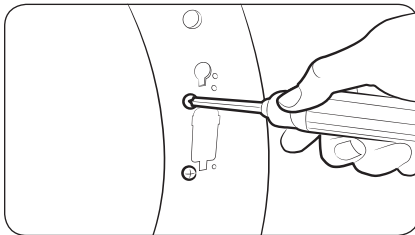

5. Remove the two screws that are above and below the cut-out in the frame front.



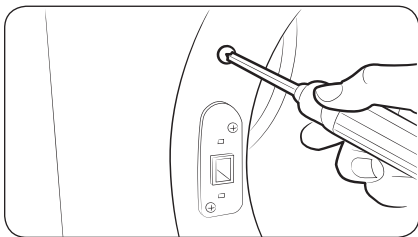

6. Remove the two screws above and below the lever holder on the opposite side of the door opening.

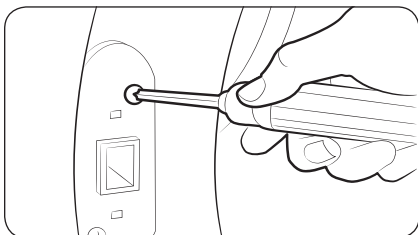

7. Remove the two screws that hold the lever holder in place, and then remove the lever holder.

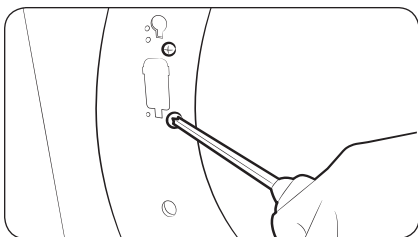

8. Re-insert the two screws that held the lever holder into the same screw holes, and then tighten.

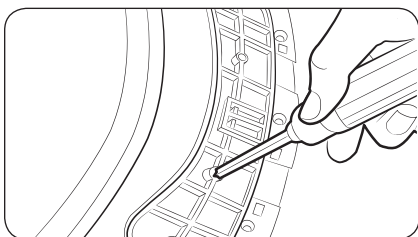

9. Remove the single screw from the back of the door hinge.

NOTE

This is the screw that supports the door against the frame so you can unscrew or screw in the hinge without needing to support the door yourself.



Installation

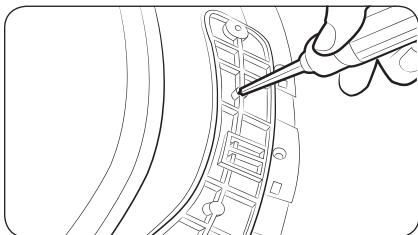

10. Insert the screw you just removed into the other screw hole on the back of the door hinge, and then tighten.

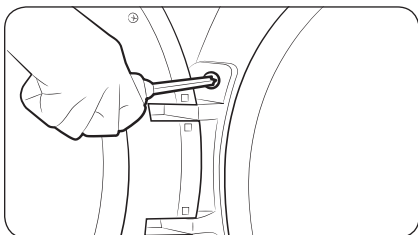

11. Place the door on the other side, and then reattach it to the dryer.

NOTE

Insert the head of the screw on the back of the hinge into the hole above the cut out in the frame, and then slide the door hinge down until it stops. Make sure the protrusion on the back of the hinge is pressed into the cut out before you tighten the hinge screws.

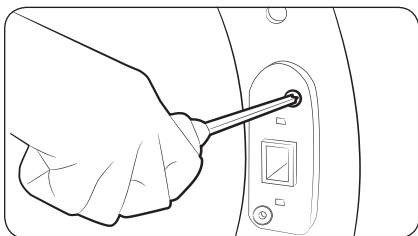

12. Push the lever holder into the cut out on the other side of the door opening. Insert screws, and then tighten as shown.

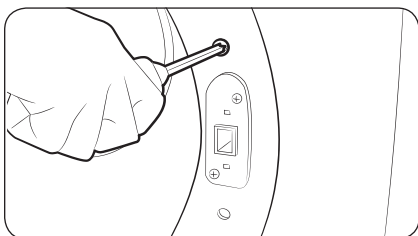

13. Re-attach the remaining screws to the remaining holes above and below the lever holder, and then tighten.



Before you start

Here are a few things you should know before starting your dryer.

Sort and load

- Put one wash load in the dryer at a time.
- Do not mix heavy and lightweight items together.
- To improve drying efficiency for one or two items, add a dry towel to the load.
- For best results, untangle items before inserting them into the dryer. Tangled items may degrade the drying efficiency or cause the door to open.
- Overloading reduces the tumbling action, resulting in uneven drying and wrinkling.
- Unless recommended on the care label, do not dry woolens or fiberglass items.
- Avoid drying unwashed items.
- Do not dry items soiled with oil, alcohol, gasoline, etc.

Functional prerequisite

Lint filter

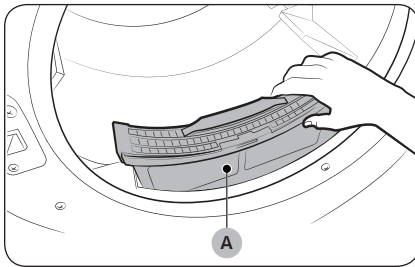

To prevent a risk of fire, make sure to clean the lint filter before or after every load.

1. Turn off the dryer.
2. Open the door and pull out the **lint filter (A)** from inside the drum.
3. Open the lint filter by separating it at the top. Remove the lint, and then clean the lint filter.
4. Close the lint filter, reinsert the lint filter into the dryer, and then close the dryer door.

⚠ CAUTION

- Do not operate the dryer without the lint filter in place.
- Do not use a damaged or broken lint filter. This may reduce performance and/or cause fire.



Operations

⚠ WARNING

To reduce the risk of fire, electric shock, or injury, read the **“Safety information”** before operating this appliance.

Control panel

DVE45B6300*

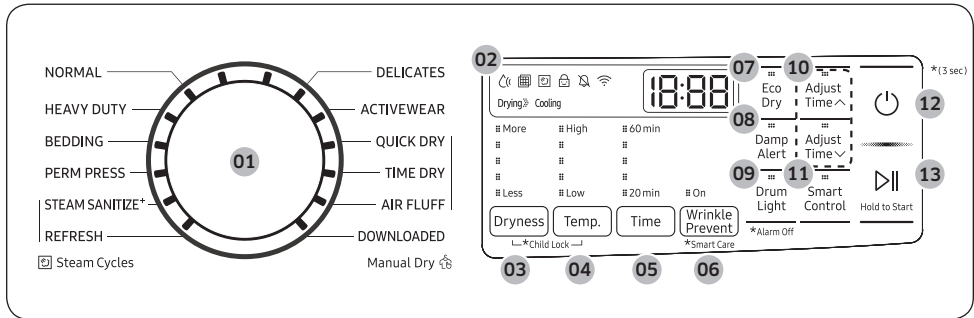

DVG45B6300*

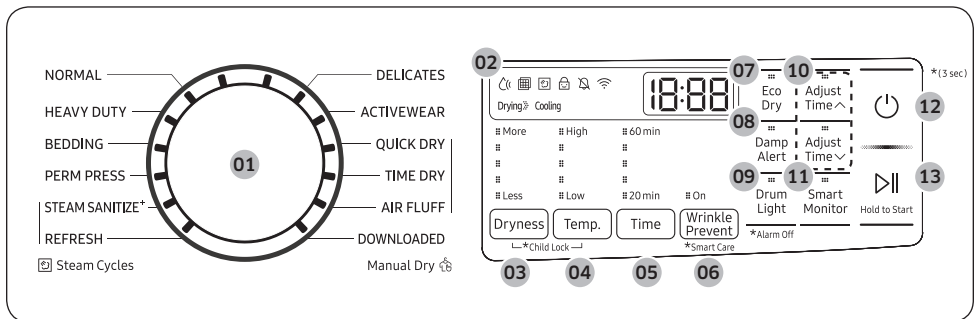

DVE50BG8300*

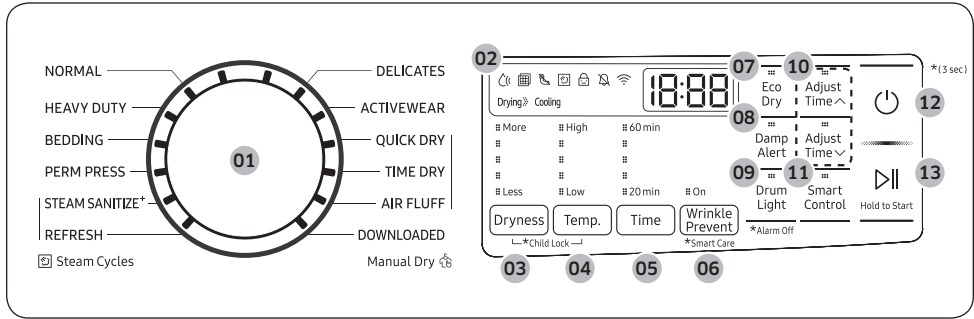

DVG50BG8300*

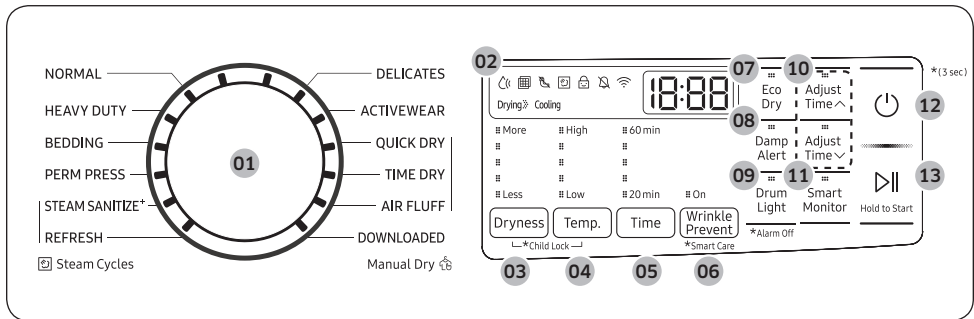

<p>01 Cycle Selector</p>	<p>Turn the Cycle Selector to select the desired cycle. The indicator by the cycle name lights up.</p> <ul style="list-style-type: none"> • Steam Cycles: The dryer sprays water into the drum to deodorize clothes and reduce static electricity and wrinkles. • Manual Dry: The drying time is fixed.
<p>02 Digital Graphic Display</p>	<p>Displays all cycle information, including the cycle time, information code, and operating status. For information about the icons, see the “Icon description” section on page 44.</p>

Operations

<p>03 Dryness</p>	<p>Press to select a dry level. You can select from 5 different options (Less to More). Please refer to following recommendations to select the appropriate dryness.</p> <ul style="list-style-type: none"> • For larger or bulkier loads, select More for complete dryness. • For items that needs to lay flat or hang to dry, use Less to partially dry items. <p> NOTE</p> <p>This option is not available with REFRESH, STEAM SANITIZE⁺, ACTIVEWEAR, TIME DRY, QUICK DRY, and AIR FLUFF.</p>
<p>04 Temp.</p>	<p>Temperature can only be adjusted in TIME DRY cycle.</p> <p>Press to change the temperature of the current cycle. You can select from 5 different options (Low to High). Please select the appropriate temperature depending on the items in the load.</p> <ul style="list-style-type: none"> • High: For sturdy cottons or those labeled Tumble Dry. • Medium: For permanent press, synthetics, lightweight cottons, or items labeled Tumble Dry Medium. • Low: For heat sensitive items labeled Tumble Dry Low or Tumble Dry Warm. Provides the lowest heated drying temperature possible.
<p>05 Time</p>	<p>Press Time to select a drying time for the selected cycle. This is available only with TIME DRY, QUICK DRY, and AIR FLUFF. This button is not available for Sensor Dry cycles because exact drying times are determined by fluctuating humidity levels.</p>
<p>06 Wrinkle Prevent</p>	<p>Wrinkle Prevent provides approximately 180 minutes of intermittent tumbling in unheated air at the end of the cycle to reduce wrinkling. Press Wrinkle Prevent to activate this feature. The load is dry and can be removed at any time during the Wrinkle Prevent cycle.</p>
<p>07 Eco Dry</p>	<p>This function is available with NORMAL and TIME DRY. With the Eco Dry activated, drying takes a longer time but power consumption is reduced. The drying time can be extended by up to 3 times normal depending on the temperature and load.</p>
<p>08 Damp Alert</p>	<p>This alert is available for all Sensor Dry cycles except for ACTIVEWEAR. Available dry levels are 2, 3, 4 and 5 (More).</p> <p>If a load contains mixed fabrics, the Damp Alert indicator blinks when average dryness of the items in the load is 80 % dry. This lets you take items that you don't want fully dried or that dry quickly out of the dryer early while letting others continue to dry.</p>
<p>09 Drum Light</p>	<p>Press to turn the interior lamp on or off. The lamp stays lit for 2 minutes after it has turned on, regardless of whether the power is on or off or the door is open or closed, and then turns off automatically.</p>

10 Adjust Time	You can change the set time for the selected cycle. This is available only with TIME DRY , QUICK DRY , and AIR FLUFF . To change the cycle time, press Adjust Time ^ or Adjust Time v until the desired time is displayed.
11 Smart Control (DVE45B6300*, DVE50BG8300* models only) / Smart Monitor (DVG45B6300*, DVG50BG8300* models only)	After connecting the Tumble Dryer to your home network using the SmartThings app, you can control or monitor the dryer remotely. When started, the Smart Control (Smart Monitor) indicator blinks. The dryer enters waiting mode and waits for remote commands.
12 Power	Press to turn on/turn off the dryer.
13 Start/Pause (Hold to Start)	Press and hold to start operation or press to stop operation.

 **NOTE**









Do not take extremely tangled items from your washer and put them into the dryer. They can degrade the drying efficiency of the dryer or cause the door to open. We recommend that you untangle the items before putting them into the dryer. Also, do not put objects on the dryer, especially on the control panel.

 **CAUTION**

Do not spray water directly onto the control panel. This may cause a system failure.

Operations

Icon description

	Sensor Dry	This icon appears when the dryer operates the cycle which senses the internal humidity to determine the drying time.
	Filter Check	This icon displays after every load as a reminder to clean the lint filter. Clean the lint filter before every cycle and make sure the filter is properly inserted before starting a cycle.
	Vent Sensor (DVE(G)50BG8300* models only)	The dryer features a vent sensor that detects and notifies you when it is time to clean the ductwork. The  indicator lets you know the status of the duct.
	Steam	This icon appears when the dryer is in steam process. The dryer sprays water into the drum to deodorize clothes and reduce static electricity and wrinkles.
	Child Lock	This icon indicates that Child Lock is on. For more information on Child Lock, see page 50.
	Alarm Off	This icon indicates that the alarm is off. For more information on Alarm Off, see page 51.
	Wi-Fi	This icon indicates that the dryer is connected to Wi-Fi.

Simple steps to start

1. Press **Power** to turn the dryer on.
2. Turn the **Cycle Selector** to select a cycle.
3. Change the cycle settings (**Dryness**, **Temp.**, and **Time**) as necessary.
4. Select desired options as necessary.
5. Press and hold **Start/Pause (Hold to Start)**.

To change the cycle during operation

1. Press **Start/Pause (Hold to Start)** to stop operation.
2. Select a different cycle, and repeat steps 2-4 above if necessary.
3. Press and hold **Start/Pause (Hold to Start)** again to start the new cycle.

Cycle overview

Standard Cycles

Cycle	Description
NORMAL	For most fabrics including cottons and linens. You can use the Eco Dry function in this cycle. For more information, see Eco Dry in the “ Control panel ” section.
HEAVY DUTY	For drying items made out of heavy fabrics, such as jeans, corduroys, or work clothes, with high temperature heat.
BEDDING	For bulky items such as blankets, sheets, and comforters.
PERM PRESS	For drying wrinkle-free cottons, synthetic fabrics, knits, and permanent press fabrics automatically.
STEAM SANITIZE⁺	Use to sanitize items by applying steam and high-temperature heat to the fabric. This cycle can make items soft and reduce smells. Confirm that the laundry load is wet or partially wet before starting this cycle.
REFRESH	Use to smooth out wrinkles and reduce odors in loads of one to four items. With this cycle selected, a small amount of water is sprayed into the dryer drum after several minutes of tumbling with heat. Before removing the laundry, confirm that the laundry load is dry.
DELICATES	For heat-sensitive items at a low drying temperature.
ACTIVEWEAR	For exercise wear and outdoor wear such as sports jerseys, training pants, water-repellent jackets, and other performance clothing. Thick fabrics like a zipper or velcro closure of a jacket, or training socks may not be completely dried.
DOWNLOADED	<ul style="list-style-type: none"> Select to choose from more cycles available on the SmartThings app on your smartphone. Available cycles: TOWELS, SANITIZE, SHIRTS, DENIM, WOOL, ECO NORMAL, LOW TEMP, RACK DRY, WRINKLE AWAY Factory setting: WRINKLE AWAY



Operations

Manual Dry

You can change the drying settings manually to your preference.

Cycle	Description
QUICK DRY	A quick drying cycle that runs for 30 minutes.
TIME DRY	You can specify a cycle time in minutes. If TIME DRY is selected, the Eco Dry function is enabled by default. For more information, see Eco Dry in the “ Control panel ” section.
AIR FLUFF	Tumbles the load in room temperature air.



Cycle chart

NOTE

For best results, follow the load size recommendations for each dry cycle.



- Large load: Fill the drum to about 3/4 full. Do not add items over this level as they need to tumble freely.
- ◐ Medium load : Fill the drum to about 1/2 full.
- ◑ Small load : Fill the drum with 3-5 items, not more than 1/4 full.

Cycle	Recommended items	Load size	Dry level
NORMAL	Cottons, work clothes, linens, mixed loads	●	Normal dry (Adjustable)
HEAVY DUTY	Heavy fabrics such as jeans, corduroys, heavy work clothes	●	Normal dry (Adjustable)
BEDDING	Bulky items such as blankets, sheets, comforters, pillows	●	Normal dry (Adjustable)
PERM PRESS	Shirts, synthetic fabrics, knits, wrinkle-free cottons, permanent press	◐	Normal dry (Adjustable)
STEAM SANITIZE ⁺	Bedding, curtains, children's clothing	◐	Very dry (Not adjustable)
REFRESH	Shirts, trousers, comforters, pillows	◑	-
DELICATES	Underwear, blouses, lingerie	◐	Normal dry (Adjustable)
ACTIVEWEAR	Water-repellent wear, performance clothes, sports wear (Maximum : 4 lbs)	◐	Normal dry (Not adjustable)
QUICK DRY	Small loads	◑	-
TIME DRY	Any load	●	-
AIR FLUFF	Foam, rubber, plastic	◑	-

Operations

 NOTE

● : factory setting, ○ : can be selected

Cycle	Functions (Temp. Control)					Time
	High				Low	
NORMAL		●				
HEAVY DUTY	●					
BEDDING	●					
PERM PRESS			●			
STEAM SANITIZE ⁺	●					
REFRESH	●					
DELICATES					●	
ACTIVEWEAR		●				
QUICK DRY	●					○
TIME DRY	●	○	○	○	○	○
AIR FLUFF						○

Cycle	Options			
	Adjust Time	Damp Alert	Eco Dry	Wrinkle Prevent
NORMAL		○	○ (DVE(G)45B6300*) ● (DVE(G)50BG8300*)	○
HEAVY DUTY		○		○
BEDDING		○		○
PERM PRESS		○		○
STEAM SANITIZE ⁺				○
REFRESH				○
DELICATES		○		○
ACTIVEWEAR				○
QUICK DRY	○			○
TIME DRY	○		●	○
AIR FLUFF	○			○

Drying guide

The best way to dry items is to follow the instructions on the care label. If no drying instructions are provided, see the following table for reference.

Items	Description
Bedspreads & Comforters	Follow the care label instructions or dry using Bedding. <ul style="list-style-type: none"> • Make sure the item is thoroughly dry before using or storing. • May require repositioning in the drum to ensure even drying.
Blankets	Use Normal and dry only one blanket at a time for best tumbling action. <ul style="list-style-type: none"> • Make sure blankets are thoroughly dry before using or storing.
Curtains & Draperies	Use PERM PRESS and the Medium temperature setting to help minimize wrinkling. <ul style="list-style-type: none"> • Dry curtains and draperies in small loads for best results and remove as soon as possible after the cycle is complete.
Cloth Diapers	Use Normal and the Medium temperature setting for soft, fluffy diapers.
Down-filled Items (jackets, sleeping bags, comforters, etc.)	Use Normal and the Medium temperature setting. <ul style="list-style-type: none"> • Add a couple of dry towels to absorb moisture and shorten drying time.
Foam Rubber (rug backs, stuffed toys, shoulder pads, etc.)	Do not dry on a heat setting. ⚠ WARNING Drying a rubber item with heat may damage it or cause a fire.
Pillows	Use Normal. <ul style="list-style-type: none"> • Add a couple of dry towels and a pair of clean sneakers to help the tumbling action and to fluff the pillows. • Do not dry kapok or foam pillows using a heated drying cycle.
Plastics (shower curtains, outdoor furniture covers, etc.)	Use TIME DRY and the Low temperature settings depending on the care label instructions.

⚠ WARNING

Do not dry:

- Fiberglass items (curtains, draperies, etc.)
- Woolens, unless recommended on the label
- Items spotted or soaked with vegetable or cooking oils



Operations

Special features

Child Lock

Child Lock prevents children from playing with the dryer. When Child Lock is activated, all buttons except for the **Power** button are disabled.

To activate/deactivate Child Lock, simultaneously press and hold **Dryness** and **Temp.** for 3 seconds.

NOTE

Once Child Lock is activated, it will remain active even after you restart the dryer. If other buttons, except for the **Power** button, do not respond, check the Child Lock indicator. If the indicator is on, follow the instructions above to turn Child Lock off.

Smart Care

To enable this function, you must first download the Samsung Smart Washer/Dryer app at the Play Store or the App Store and install it on a mobile device featuring a camera function. The Smart Care function has been optimized for Galaxy & iPhone series (applicable models only).

1. When the dryer detects an issue to check, an information code appears on the display. To enter Smart Care mode, press and hold **Wrinkle Prevent** for 3 seconds.
2. The dryer starts the self-diagnosis procedure and displays an information code if a problem is detected.
3. Run the Samsung Smart Washer/Dryer app on your mobile device, and then tap **Smart Care**.
4. Put the mobile device close to the dryer's display so that the smartphone camera and the dryer face each other. The app automatically recognizes the information code.
5. When the information code is recognized correctly, the app provides detailed information about the problem with applicable solutions.

NOTE

- The function name, Smart Care, may differ depending on the language.
- If light is reflected off the dryer's display, the app may fail to recognize the information code.
- If the app fails to recognize the information code, you can enter the code manually in the app.



Alarm off

You can turn the alarm on or off. When the alarm is off, the melody of cycle completion and the power-off beep will not sound. However, the other sounds stay active.

- Press and hold **Drum Light** for 3 seconds.
- Your setting will be retained even after you turn off the dryer. You can turn the alarm back on by pressing and holding the same button for 3 seconds.

DOWNLOADED cycle

You can choose from more cycles available on the SmartThings app on your smartphone.

1. On your smartphone, select the **DOWNLOADED** cycle.
You can choose from TOWELS, SANITIZE, SHIRTS, DENIM, WOOL, ECO NORMAL, LOW TEMP, RACK DRY, and WRINKLE AWAY.
2. Press **Power** on your dryer.
3. Turn the **Cycle Selector** to **DOWNLOADED**.
4. Press and hold **Start/Pause (Hold to Start)**.



Operations

SmartThings

Wi-Fi connection

On your smartphone, go to **Settings**, turn on the wireless connection, and then select your AP (Access Point).

- This appliance supports the Wi-Fi 2.4 GHz protocols.

Download

On an app market (Google Play Store, Apple App Store, Samsung Galaxy Apps), find the SmartThings app using the search term "SmartThings". Download and install the app on your device.

NOTE

The app is subject to change without notice for improved performance.

Log in

You must first log into SmartThings with your Samsung account. To create a new Samsung account, follow the instructions in the app. You don't need a separate app to create your account.

NOTE

If you have a Samsung account, use the account to log in. A registered Samsung smartphone user automatically logs in.

To register your appliance to SmartThings

1. Make sure your smartphone is connected to a wireless network. If not, go to **Settings** and turn on the wireless connection, and then select your AP (Access Point).
2. Open **SmartThings** on your smartphone.
3. If the "A new device is found." message appears, select **Add**.
4. If no message appears, select **+** and then select your appliance from the list of devices available. If your appliance is not listed, select **Device Type > Specific Device Model**, and then add your appliance manually.
5. Register your appliance to the SmartThings app.
 - a. Add your appliance to SmartThings. Make sure your appliance is connected to SmartThings.
 - b. When registration is complete, then name of your appliance appears on your smartphone.



Maintenance

Keep the dryer clean to prevent decreased performance and to lengthen its life.

WARNING

Certain internal parts are intentionally not grounded and may present a risk of electric shock only during servicing.

Service Personnel - Do not contact the following parts while the appliance is energized: Control board and inlet valve.

Vent sensor

The dryer features a vent sensor that detects and notifies you when it is time to clean the ductwork. The  indicator lets you know the status of the duct.

Level	 Indicator	Status	Action
0	Off	The ductwork is not clogged.	
1	On	<ul style="list-style-type: none">The duct or lint filter is clogged.The pressure applied to the duct is high because the duct is too long or bent.	<ul style="list-style-type: none">Check the lint filter or duct and clean if necessary.Check the duct connections and shorten or straighten the duct if necessary.
2	Blinking	<ul style="list-style-type: none">The duct or lint filter is severely clogged.The pressure applied to the duct is very high because the duct is too long or bent.	<ul style="list-style-type: none">Check and clean the lint filter or duct and make sure they are not clogged.Check the duct connections and shorten or straighten the duct work.

If the dryer is in the Level 2 state, the  indicator blinks for 3 hours after the completion of the current cycle. If you press **Power** or open the door, the dryer powers off immediately.

NOTE

- For duct installation, see "**Exhaust ducting guide**".
- The dryer may keep running even if the duct is clogged, but the drying time will be extended.
- If the indicator turns on for the first time and is solid (not blinking), check and clean the lint filter and/or duct.
- If the indicator turns on again later, it is because the duct is installed or connected with some restrictions (it's too long or has too many bends). This is not a system failure. However, drying time may be extended or the drying performance may be degraded.



Maintenance

Cleaning

Control panel

- Clean with a soft, damp cloth. Do not use abrasive substances.
- Do not spray liquid cleaning agents directly onto the dryer display.
- Some laundry pre-treatment soil and stain removers may damage the control panel.
- When using liquid cleaning agents, apply them to the cleaning cloth. Do not apply them directly to the dryer. Wipe up any spills or overspray immediately.

Drum

- Remove any stains from the drum with an all-purpose cleaner.
- Tumble old towels or rags to remove any remaining stains or cleaning substances. Stains may still be visible, but will not affect subsequent loads.

Powder coated drum

To clean the powder coated drum, use a damp cloth with a mild, non-abrasive cleaner suitable for easily marred surfaces.

Remove cleaner residue and dry with a clean cloth.

Dryer exterior

- Clean with a soft, damp cloth. Do not use abrasive substances.
- Protect the surface from sharp objects.
- Do not place any heavy or sharp objects or a detergent container on the dryer. They can scratch or damage the top cover of the dryer.
- The dryer has a high-gloss finish on the entire surface. Be careful not to scratch or damage the surface.

Exhaust system

- Check and clean the exhaust system on a regular basis to maintain optimum performance.
- The external exhaust hood must be cleaned frequently to ensure proper air flow.



Troubleshooting

Checkpoints

If the dryer operates abnormally, first check the list of problems in the table below and try the suggested actions.

Problem	Action
Does not run.	<ul style="list-style-type: none"> • Make sure the door is latched shut. • Make sure the power cord is plugged into a live electrical outlet. • Check your home's circuit breakers or fuses. • Press or tap Start/Pause (Hold to Start) again if the door was opened during a cycle. • Clean the lint filter.
Does not heat.	<ul style="list-style-type: none"> • Check your home's circuit breakers or fuses. • Some cycles do not require heat. Check the selected cycle again. • For a gas dryer, make sure the gas supply is on. • Clean the lint filter and exhaust duct. • The dryer may have moved into the cool-down phase of the cycle. • Turn off the Eco Dry option for the NORMAL or TIME DRY cycles. When the Eco Dry option is on, the dryer performs an air dry process in the beginning of the cycle to reduce energy consumption. The air dry process does not use heated air, so you may feel that the dryer is not being heated, but this is normal.
Does not dry.	<ul style="list-style-type: none"> • Check all of the above, plus... • Make sure the exhaust hood outside your home can open and close freely. • Check the exhaust system for lint buildup. Ducting should be inspected and cleaned annually. • Use a 4" rigid metal exhaust duct. • Do not overload. 1 wash load = 1 dryer load. • Dry heavy items and light weight items separately. • Large, bulky items, such as blankets or comforters, may require repositioning to ensure even drying. • Make sure that your washer is draining properly and extracting adequate water from the load. • The load may be too small to tumble properly. Add a few towels and restart the dryer. • The load may be too large to tumble properly. Remove some items and restart the dryer. • Clean the lint filter.

Troubleshooting

Problem	Action
Is noisy.	<ul style="list-style-type: none"> • Check the load for objects such as coins, loose buttons, nails, etc. Remove promptly. • It is normal to hear the dryer gas valve or heating element cycle on and off during the drying cycle. • Make sure the dryer is leveled properly as outlined in the installation instructions. • It is normal for the dryer to hum due to the high velocity of air moving through the dryer drum, fan, or exhaust system.
Dries unevenly.	<ul style="list-style-type: none"> • Seams, pockets, and other similarly heavy areas may not be completely dry when the rest of the load has reached the selected dryness level. This is normal. You can choose a higher dryness level or a cycle that involves a higher dryness level. • If one heavy item is dried with a light weight load, such as one towel with sheets, it is possible that the heavy item will not be completely dry when the rest of the load has reached the selected dryness level. • For the best drying results, dry heavy items and light weight items separately.
Has odors.	<ul style="list-style-type: none"> • Household odors from paint, varnish, strong cleaners, etc. may enter the dryer with the surrounding room air. This is normal as the dryer draws the air from the room, heats it, pulls it through the tumbler, and exhausts it outside. • When these odors linger in the air, completely ventilate the room before using the dryer. • Use the REFRESH cycle. If odors persist, wash and dry the items again.
Lint on clothes.	<ul style="list-style-type: none"> • Make sure the lint filter is cleaned before every load. For clothes that naturally build up lint, clean the filter during the cycle. • Some fabrics are lint producers (for example, a fuzzy white cotton towel) and they must be dried separately from clothes that are lint trappers (for example, a pair of black linen pants). • Divide larger loads into smaller loads for drying. • Check pockets thoroughly before drying, then dry clothes. • Remove lint inside the drum before drying a load.
Items still wrinkled after Wrinkle Prevent (Wrinkle Away, Wrinkle Release).	<ul style="list-style-type: none"> • Small loads of 1 to 4 items work best. • Load fewer items. Load similar-type items. • Take out the items immediately after drying is complete.
Water drips from the nozzle when the Steam cycles starts.	<ul style="list-style-type: none"> • This is steam condensation. The dripping water will stop after a short time.

Problem	Action
Sprayed water is not visible during Steam cycles.	<ul style="list-style-type: none">• Sprayed water is difficult to see when the door is closed.
Extended time.	<ul style="list-style-type: none">• Sensor Dry automatically senses the moisture in the load and shuts the dryer off when the selected dryness level is reached. The drying time can change according to the type and amount of laundry. See the cycle chart for reference.

If a problem persists, contact a local Samsung service center.



Troubleshooting

Information codes

If the dryer fails to operate, you may see an information code on the display panel. To determine what you should do, check the list of codes in the table below, and then try the suggested actions.

Code	Action
dC	Operating the dryer with the door open. <ul style="list-style-type: none"> • Make sure the door is properly closed. • Make sure laundry is not caught in the door.
FC	Invalid power source frequency. <ul style="list-style-type: none"> • Try restarting the cycle. • If this information code remains, contact a Samsung service center.
AC	Electronic control problem (Invalid Communication). <ul style="list-style-type: none"> • Contact a Samsung service center.
HC	High temperature heating check. <ul style="list-style-type: none"> • Clean the lint filter. • If this information code remains, contact a Samsung service center.
9C1	The electronic control needs to be checked. <ul style="list-style-type: none"> • Check if power is supplied properly. • If the information code remains, contact a Samsung service center.
tC	The Thermistor1 resistance is very low or high. <ul style="list-style-type: none"> • Check for a clogged lint screen. • Check if the vent system is restricted. • If this information code remains, contact a Samsung service center.
tC5	The Thermistor2 resistance is very low or high. <ul style="list-style-type: none"> • Check for a clogged lint screen. • Check if the vent system is restricted. • If this information code remains, contact a Samsung service center.
dF	Incorrect door switch. <ul style="list-style-type: none"> • Contact a Samsung service center.
3C	The PBA needs to be checked. <ul style="list-style-type: none"> • Unplug the power plug and contact a Samsung service center.

If any information code keeps appearing on the display, contact a Samsung service center.







Specifications



Fabric care chart

The following symbols provide garment care direction. The clothing care labels include symbols for drying, bleaching, ironing, and dry cleaning. The use of symbols ensures consistency among garment manufacturers of domestic and imported items. Follow care label directions to optimize garment life and reduce laundering problems.

Wash cycle

	Normal
	Permanent press/Wrinkle resistant/Wrinkle control
	Gentle/Delicates
	Hand wash



Water temperature

	Hot
	Warm
	Cold



NOTE

The Water Temperature table lists appropriate wash water temperatures for various items. The temperature range is 106-126 °F (41-52 °C) for Hot, 84-106 °F (29-41 °C) for Warm, and 61-84 °F (16-29 °C) for Cold. (Wash water temperature must be a minimum of 61 °F (16 °C) for detergent activation and effective cleaning.)



Bleach

	Any bleach (when needed)
	Only non-chlorine (color-safe) bleach (when needed)
	Tumble dry





Normal

	Permanent press/Wrinkle resistant/Wrinkle control
	Gentle/Delicates



Special instructions

	Line dry/Hang to dry
	Drip dry
	Dry flat

Heat setting

	High
	Medium
	Low
	Any heat
	No heat / Air

Iron dry or steam temperatures

	High
	Medium
	Low



Specifications

Warning symbols for laundering

	Do not wash
	Do not wring
	Do not bleach
	Do not tumble dry
	No steam (added to iron)
	Do not iron

Dry-clean

	Dry-clean
	Do not dry-clean
	Line dry / Hang to dry
	Drip dry
	Dry flat

Protecting the environment

This appliance is manufactured from recyclable materials. If you decide to dispose of this appliance, please observe local waste disposal regulations. Cut off the power cord so that the appliance cannot be connected to a power source. Remove the door so that animals and small children cannot get trapped inside the appliance.

Specification sheet

Type		Front loading dryer
Capacity (Cu.ft)		7.5
Water pressure (psi (kPa))		20-116 (137-800)
Weight	lb (kg)	119.0 (54)
Heater rating	Electric (W)	5300
	Gas (BTU/hr)	20000
Power consumption (W)		5400



LIMITED WARRANTY (U.S.A.)

SAMSUNG DRYER

LIMITED WARRANTY TO ORIGINAL CONSUMER PURCHASER WITH PROOF OF PURCHASE

This SAMSUNG brand product, as supplied and distributed by SAMSUNG ELECTRONICS AMERICA, INC. (SAMSUNG) and delivered new, in the original carton to the original consumer purchaser, is warranted by SAMSUNG against manufacturing defects in materials or workmanship for the limited warranty period, starting from the date of original purchase, of:

One (1) Year All Parts and Labor

This limited warranty is valid only on products purchased and used in the United States that have been installed, operated, and maintained according to the instructions attached to or furnished with the product. To receive warranty service, the purchaser must contact SAMSUNG at the address or phone number provided below for problem determination and service procedures. Warranty service can only be performed by a SAMSUNG authorized service center. The original dated bill of sale must be presented upon request as proof of purchase to SAMSUNG or SAMSUNG's authorized service center to receive warranty service.

SAMSUNG will provide in-home service within the contiguous United States during the warranty period at no charge, subject to availability of SAMSUNG authorized servicers within the customer's geographic area. If in-home service is not available, SAMSUNG may elect, at its option, to provide transportation of the product to and from an authorized service center. If the product is located in an area where service by a SAMSUNG authorized servicer is not available, you may be responsible for a trip charge or required to bring the product to a SAMSUNG authorized service center for service.

To receive in-home service, product must be unobstructed and accessible to the service agent.

During the applicable warranty period, a product will be repaired, replaced, or the purchase price refunded, at the sole option of SAMSUNG. SAMSUNG may use new or reconditioned parts in repairing a product, or replace the product with a new or reconditioned product. Replacement parts and products are warranted for the remaining portion of the original product's warranty or ninety (90) days, whichever is longer. All replaced parts and products are the property of SAMSUNG and you must return them to SAMSUNG.

This limited warranty covers manufacturing defects in materials or workmanship encountered in normal household, noncommercial use of this product and shall not cover the following: damage that occurs in shipment, delivery, installation, and uses for which this product was not intended; damage caused by unauthorized modification or alteration of the product; product where the original factory serial numbers have been removed, defaced, changed in any way, or cannot be readily determined; cosmetic damage including scratches, dents, chips, and other damage to the product's finishes; damage caused by abuse, misuse, pest infestations, accident, fire, floods, or other acts of nature or God; damage caused by use of equipment, utilities, services, parts, supplies, accessories, applications, installations, repairs, external wiring or connectors not supplied or authorized by SAMSUNG; damage caused by incorrect electrical line current, voltage, fluctuations and surges; damage caused by failure to operate and maintain the product according to instructions; in-home instruction on how to use your product; and service to correct installation not in accordance with electrical or plumbing codes or correction of household electrical or plumbing (i.e., house wiring, fuses, or water inlet hoses). The cost of repair or replacement under these excluded circumstances shall be the customer's responsibility.

LIMITED WARRANTY (U.S.A.)

Visits by an authorized servicer to explain product functions, maintenance or installation are not covered by this limited warranty. Please contact SAMSUNG at the number below for assistance with any of these issues.

EXCLUSION OF IMPLIED WARRANTIES

IMPLIED WARRANTIES, INCLUDING THE IMPLIED WARRANTIES OF MERCHANTABILITY OR FITNESS FOR A PARTICULAR PURPOSE, ARE LIMITED TO ONE YEAR OR THE SHORTEST PERIOD ALLOWED BY LAW.

Some states do not allow limitations on how long an implied warranty lasts, so the above limitations or exclusions may not apply to you. This warranty gives you specific rights, and you may also have other rights, which vary from state to state.

LIMITATION OF REMEDIES

YOUR SOLE AND EXCLUSIVE REMEDY IS PRODUCT REPAIR, PRODUCT REPLACEMENT, OR REFUND OF THE PURCHASE PRICE AT SAMSUNG'S OPTION, AS PROVIDED IN THIS LIMITED WARRANTY. SAMSUNG SHALL NOT BE LIABLE FOR SPECIAL, INCIDENTAL OR CONSEQUENTIAL DAMAGES, INCLUDING BUT NOT LIMITED TO TIME AWAY FROM WORK, HOTELS AND/OR RESTAURANT MEALS, REMODELING EXPENSES, LOSS OF REVENUE OR PROFITS, FAILURE TO REALIZE SAVINGS OR OTHER BENEFITS REGARDLESS OF THE LEGAL THEORY ON WHICH THE CLAIM IS BASED, AND EVEN IF SAMSUNG HAS BEEN ADVISED OF THE POSSIBILITY OF SUCH DAMAGES. Some states do not allow exclusion or limitation of incidental or consequential damages, so the above limitations or exclusions may not apply to you. This warranty gives you specific rights, and you may also have other rights, which vary from state to state.

SAMSUNG does not warrant uninterrupted or error-free operation of the product. No warranty or guarantee given by any other person, firm, or corporation with respect to this product shall be binding on SAMSUNG.

To obtain warranty service, please contact SAMSUNG at:

Samsung Electronics America, Inc.

85 Challenger Road

Ridgefield Park, NJ 07660

1-800-SAMSUNG (726-7864)

www.samsung.com/us/support

Warranty (CANADA)

SAMSUNG DRYER

LIMITED WARRANTY TO ORIGINAL PURCHASER

This SAMSUNG brand product, as supplied and distributed by SAMSUNG ELECTRONICS CANADA, INC. (SAMSUNG) and delivered new, in the original carton to the original consumer purchaser, is warranted by SAMSUNG against manufacturing defects in materials and workmanship for a limited warranty period of:

- One (1) year part and labor

This limited warranty begins on the original date of purchase, and is valid only on products purchased and used in the Canada.

To receive warranty service, the purchaser must contact SAMSUNG for problem determination and service procedures.

Warranty service can only be performed by a SAMSUNG authorized service center.

The original dated bill of sale must be presented upon request as proof of purchase to SAMSUNG or SAMSUNG's authorized service center.

SAMSUNG will provide in-home service during the warranty period at no charge, subject to availability within the Canada.

In-home service is not available in all areas.

To receive in-home service, product must be unobstructed and accessible to the service agent.

If service is not available, SAMSUNG may elect to provide transportation of the product to and from an authorized service center.

SAMSUNG will repair, replace, or refund this product at our option and at no charge as stipulated herein, with new or reconditioned parts or products if found to be defective during the limited warranty period specified above.

All replaced parts and products become the property of SAMSUNG and must be returned to SAMSUNG.

Replacement parts and products assume the remaining original warranty, or ninety (90) days, whichever is longer.

This limited warranty covers manufacturing defects in materials and workmanship encountered in normal, noncommercial use of this product and shall not apply to the following: damage that occurs in shipment; delivery and installation; applications and uses for which this product was not intended; altered product or serial numbers; cosmetic damage or exterior finish; accidents, abuse, neglect, fire, water, lightning, or other acts of nature or God; use of products, equipment, systems, utilities, services, parts, supplies, accessories, applications, installations, repairs, external wiring or connectors not supplied or authorized by SAMSUNG that damage this product or result in service problems; incorrect electrical line voltage, fluctuations and surges; customer adjustments and failure to follow operating instructions, maintenance and environmental instructions that are covered and prescribed in the instruction book; product removal and reinstallation; problems caused by pest infestations.

This limited warranty does not cover problems resulting from incorrect electric current, voltage or supply, light bulbs, house fuses, house wiring, cost of a service call for instructions, or fixing installation errors.

SAMSUNG does not warrant uninterrupted or error-free operation of the product.

Warranty (CANADA)

EXCEPT AS SET FORTH HEREIN, THERE ARE NO WARRANTIES ON THIS PRODUCT EITHER EXPRESS OR IMPLIED, AND SAMSUNG DISCLAIMS ALL WARRANTIES INCLUDING, BUT NOT LIMITED TO, ANY IMPLIED WARRANTIES OF MERCHANTABILITY, INFRINGEMENT OR FITNESS FOR A PARTICULAR PURPOSE. NO WARRANTY OR GUARANTEE GIVEN BY ANY PERSON, FIRM, OR CORPORATION WITH RESPECT TO THIS PRODUCT SHALL BE BINDING ON SAMSUNG.

SAMSUNG SHALL NOT BE LIABLE FOR LOSS OF REVENUE OR PROFITS, FAILURE TO REALIZE SAVINGS OR OTHER BENEFITS, OR ANY OTHER SPECIAL, INCIDENTAL OR CONSEQUENTIAL DAMAGES CAUSED BY THE USE, MISUSE, OR INABILITY TO USE THIS PRODUCT, REGARDLESS OF THE LEGAL THEORY ON WHICH THE CLAIM IS BASED, AND EVEN IF SAMSUNG HAS BEEN ADVISED OF THE POSSIBILITY OF SUCH DAMAGES. NOR SHALL RECOVERY OF ANY KIND AGAINST SAMSUNG BE GREATER IN AMOUNT THAN THE PURCHASE PRICE OF THE PRODUCT SOLD BY SAMSUNG AND CAUSING THE ALLEGED DAMAGE.

WITHOUT LIMITING THE FOREGOING, PURCHASER ASSUMES ALL RISK AND LIABILITY FOR LOSS, DAMAGE, OR INJURY TO PURCHASER AND PURCHASER'S PROPERTY AND TO OTHERS AND THEIR PROPERTY ARISING OUT OF THE USE, MISUSE, OR INABILITY TO USE THIS PRODUCT.

THIS LIMITED WARRANTY SHALL NOT EXTEND TO ANYONE OTHER THAN THE ORIGINAL PURCHASER OF THIS PRODUCT, IS NONTRANSFERABLE AND STATES YOUR EXCLUSIVE REMEDY.

Some provinces do not allow limitations on how long an implied warranty lasts, or the exclusion or limitation of incidental or consequential damages, so the above limitations or exclusions may not apply to you.

This warranty gives you specific rights, and you may also have other rights, which vary from province to province.

To obtain warranty service, please contact SAMSUNG at:

Samsung Electronics Canada Inc.

2050 Derry Road West,

Mississauga, Ontario L5N 0B9 Canada

1-800-SAMSUNG (726-7864)

www.samsung.com/ca/support (English)

www.samsung.com/ca_fr/support (French)

Visits by a Service Engineer to explain functions, maintenance, or installation is not covered by warranty. Please contact the Samsung call center at the number above for help with any of these issues.

Memo

Memo

Memo



Scan the QR code* or visit
www.samsung.com/spsn
to view our helpful
How-to Videos and Live Shows

*Requires reader to be installed on your smartphone

Scan this with your smartphone



Energy Star only applies to DVE(G)50BG8300* model.

This product qualifies for ENERGY STAR in the factory default
"Normal + Eco dry" setting.

If you change the factory default setting or enable other features,
power consumption could increase and exceed the limits qualified
for ENERGY STAR.

QUESTIONS OR COMMENTS?

COUNTRY	CALL	OR VISIT US ONLINE AT
U.S.A	1-800-SAMSUNG (726-7864)	www.samsung.com/us/support
CANADA	1-800-SAMSUNG(726-7864)	www.samsung.com/ca/support (English) www.samsung.com/ca_fr/support (French)