

WARNING

- * Switch off the main electrical supply from the main fuse box / circuit.
- * Breaker before installation.
- * Inspect item carefully before attempting to install.
- * If there is any damages or obvious defects, do not install.
- * Item may not be returned once it has been installed.





CARE AND MAINTENANCE

- * The best and safest cleaner for a mirror is clean, warm water used with a soft cloth. Be careful not to allow the edges of the mirror to get or remain wet over a period of time.
- * If using a commercial glass or mirror cleaner, be sure to use a standard brand of glass or mirror cleaner that does not contain ammonia or vinegar. Do not use Windex. Never spray any cleaner directly on to a mirror. Instead, apply the cleaner to a soft cloth and then wipe the mirror.
- * Always use soft, grit-free cloths when cleaning a mirror to reduce chances of scratching the surface.
- * Be sure to dry all joints and edges thoroughly to be certain that no commercial cleaner comes in contact with the edges and backing.

NOTICE & IMPORTANT SAFETY INSTRUCTIONS

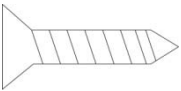
- ** WE RECOMMEND INSTALLATION OF THIS LIGHTING FIXTURE BE DONE BY A LICENSED ELECTRICIAN **
 - * Please make sure that you have all parts indicated before you begin assembly of this item
 - * This item should be assembled on a soft surface to prevent scratching the finish during assembly
 - * To reduce the risk of fire, electrical shock or injury to persons or property, please follow the guideline below for safe use and installation
 - * The external flexible cable or cord of this lamp cannot be replaced
- If the cord is damaged, the lamp shall be destroyed

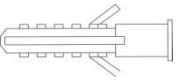
Part List and Hardware List

PIECE	DESCRIPTION	PICTURE	QUANTITY	PIECE	DESCRIPTION	PICTURE	QUANTITY
A	mounting screw		4X	C	wire nut		3X
B	gecko		4X	D	lamp body		1X

Product Dimensions: 36"L X 36"H X 1.25"D

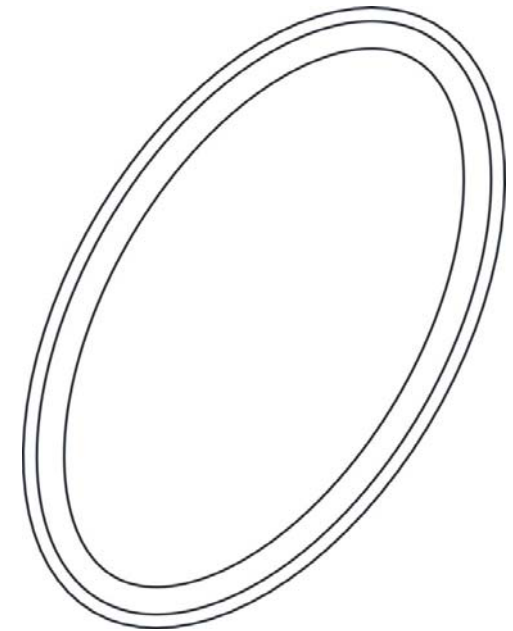

PREPARATION

- * Before beginning assembly of product, make sure all parts are present. Compare parts with package contents list and hardware contents list.
- * If any part is missing or damaged, do not attempt to assemble the product.
- * Estimated Assembly Time: 20 minutes.
- * Tools Required for Assembly (excluded): Screw driver, Pencil, Drill with 1/4" bit, Level, Measuring Tape
- * If you are having difficulty, our friendly Customer Care team is always here to help.

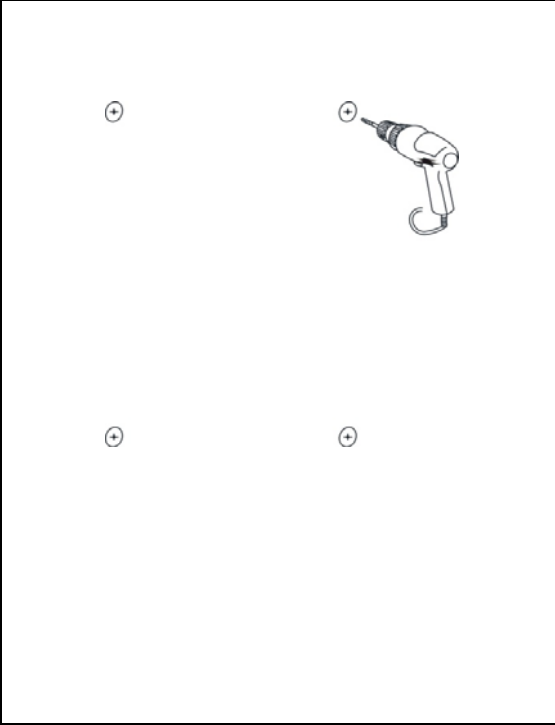

Step 1: Mark the position of hanging screw on the wall with pencil. Drill four hang holes with an electric drill and fix mounting screw with gecko.

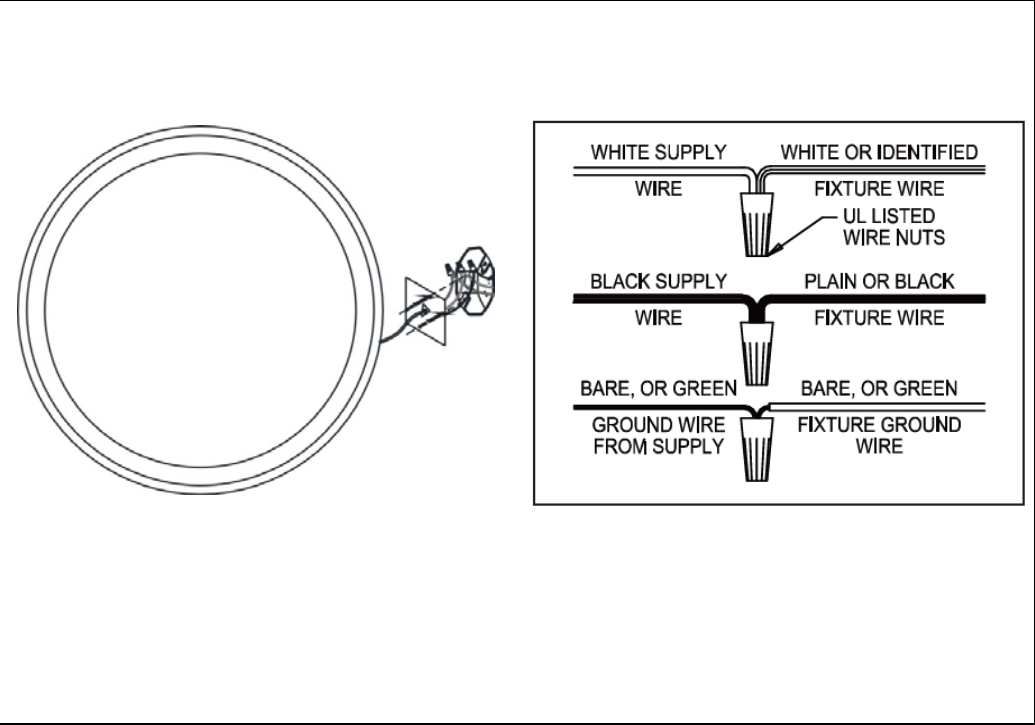

Step 2: Connect the cable to power source in wall with wire nut.

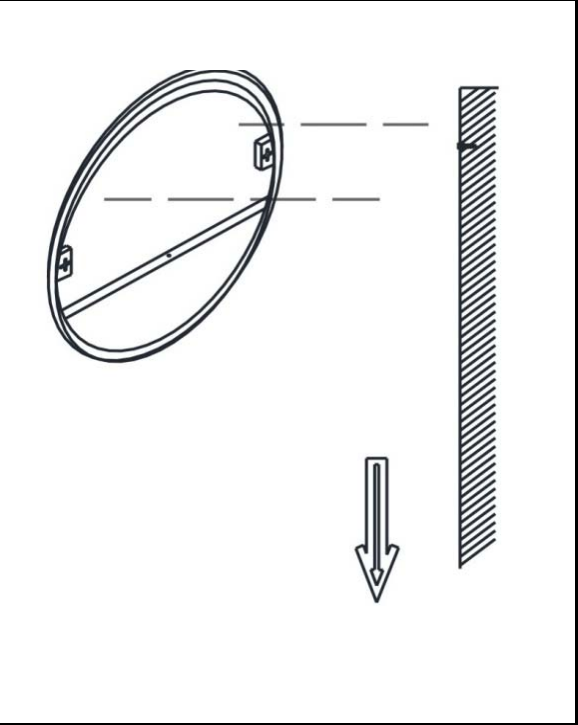

Step 3: Hang the mirror onto wall screws.