

ASSEMBLY INSTRUCTION (Instructions de montage)

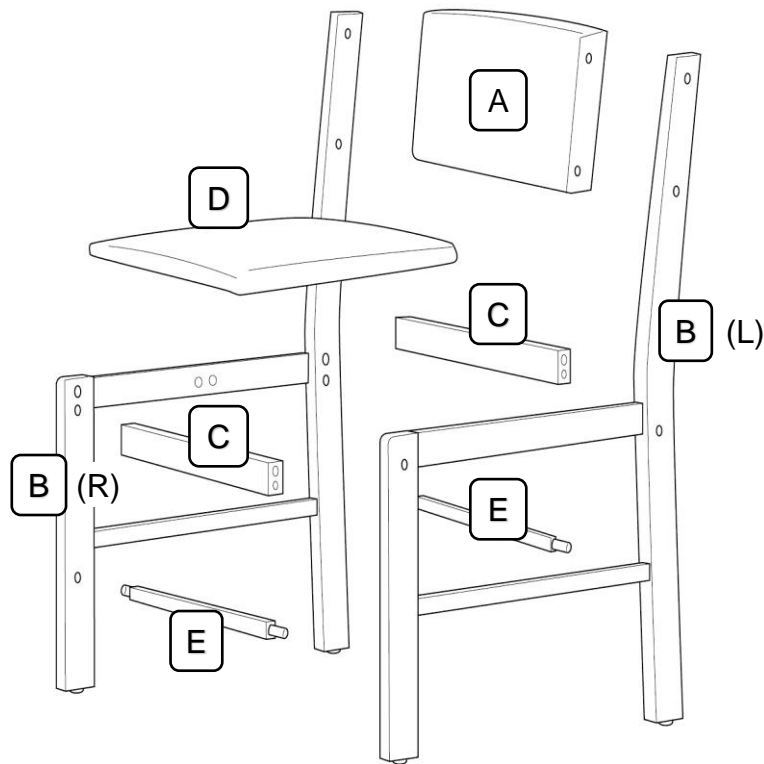

NOTE: 50% TIGHTEN BEFORE FIXING ALL BOLTS
(REMARQUE : SERRER 50% AVANT DE FIXER TOUS LES BOULONS)



Notice:

1 50% Tighten before fixing all screws, wrench is recommended instead of an electric drill.

2 Place the item on a flat ground to adjust and make sure it remains
3 stable.





4 Tighten up all screws with tools gradually.

If the screws are not aligned with holes during assembly, please loosen
5 all the other screws to 50% and continue the assembly process.



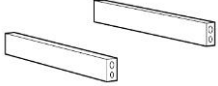

If the item is not stable, please loosen all the screws, adjust it on a flat
6 ground and tighten up all screws again.

Note : If one or some screws are fully tightened during assembly, chances are the others will not be aligned with holes. In addition, all the holes are designed to be relatively larger to provide more space for the adjustment of the screws.

PART LIST (LISTE DES PIÈCES) FOR 4 PCS CHAIRS

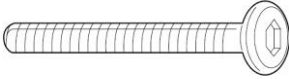
A	 <p>Backrest (4PCS) (Dossier chaise)</p>	 <p>Leg Frame (8PCS) (4 PCS RIGHT + 4 PCS LEFT) (Cadre de jambe)</p>	 <p>Front & Back Rail (8PCS) (Rail avant et arrière)</p>
D	 <p>Cushion (4PCS) (Coussin)</p>	 <p>Front & Back Stretcher (8PCS) (Étireur avant et arrière)</p>	

HARDWARE LIST (LISTE DU MATÉRIEL) FOR 4 PCS CHAIRS

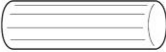
1	 <p>Bolt 1/4" x 50mm (32+1PCS) (Boulon)</p>	 <p>Spring Washer M6 (32+1PCS) (Rondelle Élastique)</p>	 <p>Barrel Nut M6 (16+1PCS) (Écrou à barillet)</p>
4	 <p>Screw 1/8" x 32mm (32+1PCS) (Vis Bois Anti)</p>	 <p>Wood Dowel M8 x 30mm (16+1PCS) (Cheville en bois)</p>	 <p>Wood Dowel M10 x 40mm (16+1PCS) (Cheville en bois)</p>

HARDWARE LIST (LISTE DU MATÉRIEL) FOR 4 PCS CHAIRS

7

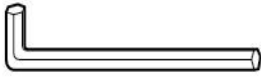

Allen Key 4mm (1PC)
(Clé Allen)

8

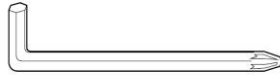

CSK Allen Key 4mm (1PC)
(Clé Allen CSK)

STEP 1

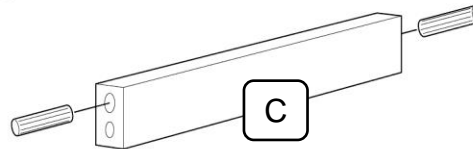
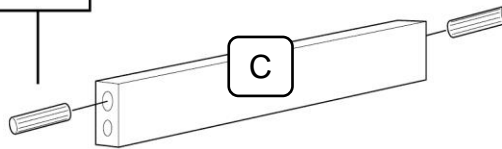
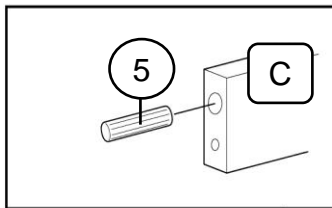

5





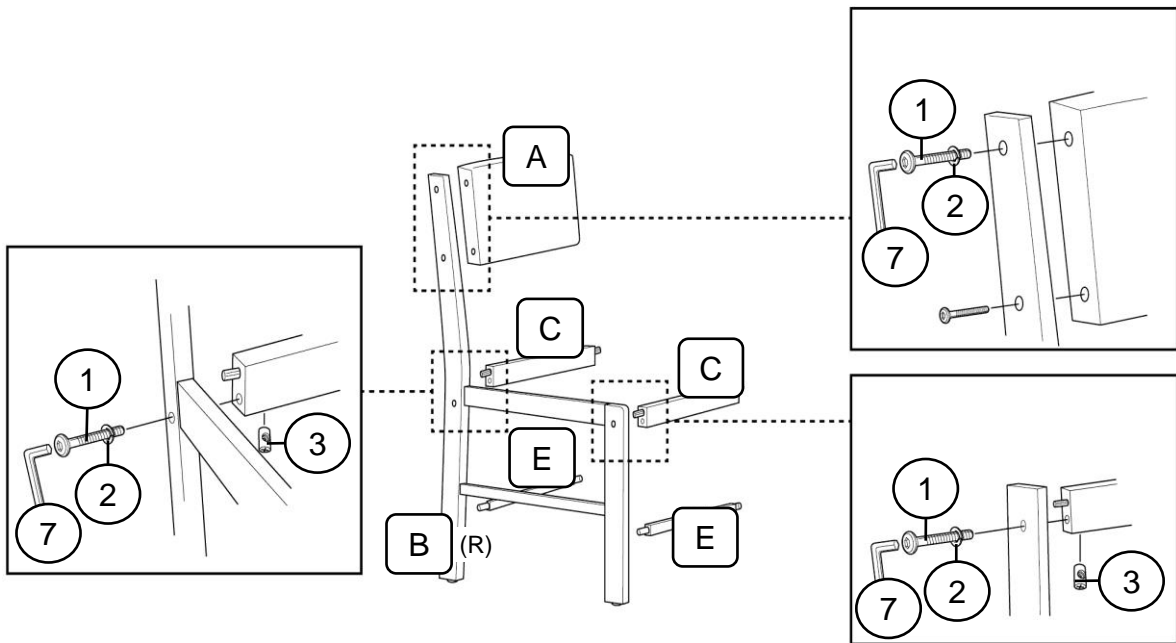

Wood Dowel (Cheville en bois)

4pcs

STEP 3





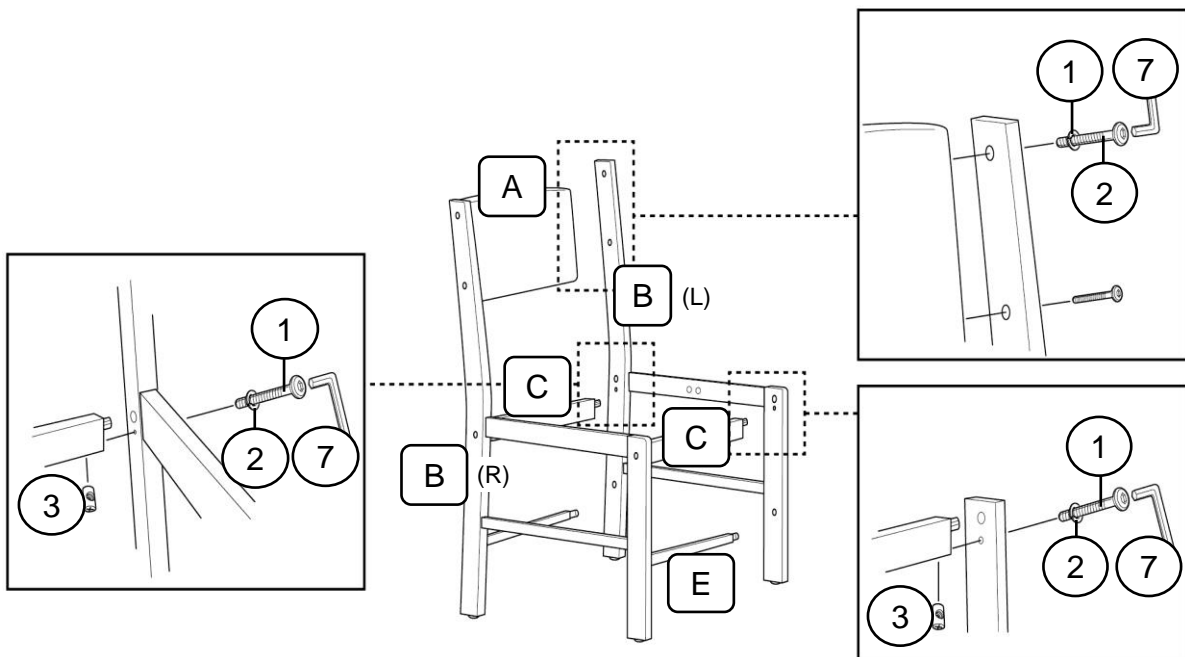

1		Bolt 1/4" x 50mm (Boulon)	4pcs
2		Spring Washer M6 (Rondelle Plate)	4pcs

3		Barrel Nut M6 (Écrou à barillet)	2pcs
7		Allen Key 4mm (Clé Allen)	1pc

STEP 4



1		Bolt 1/4" x 50mm (Boulon)	4pcs
2		Spring Washer M6 (Rondelle Plate)	4pcs

3		Barrel Nut M6 (Écrou à barillet)	2pcs
7		Allen Key 4mm (Clé Allen)	1pc

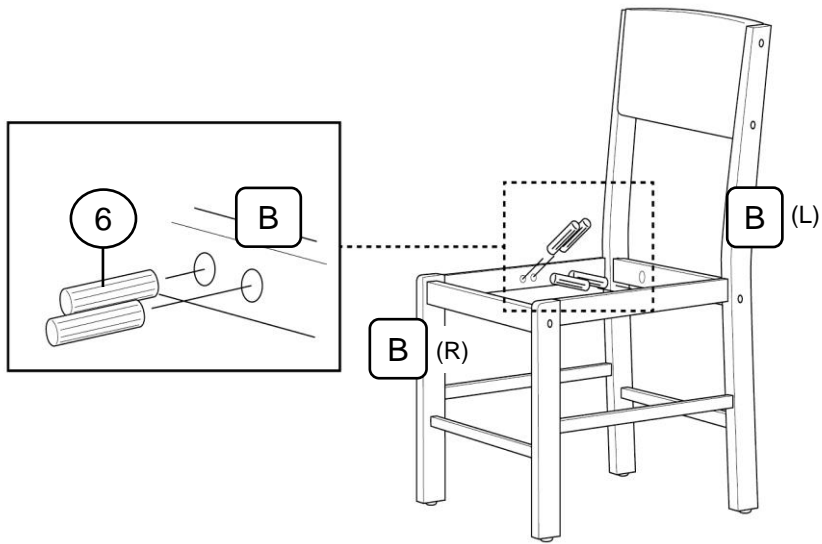

STEP 5

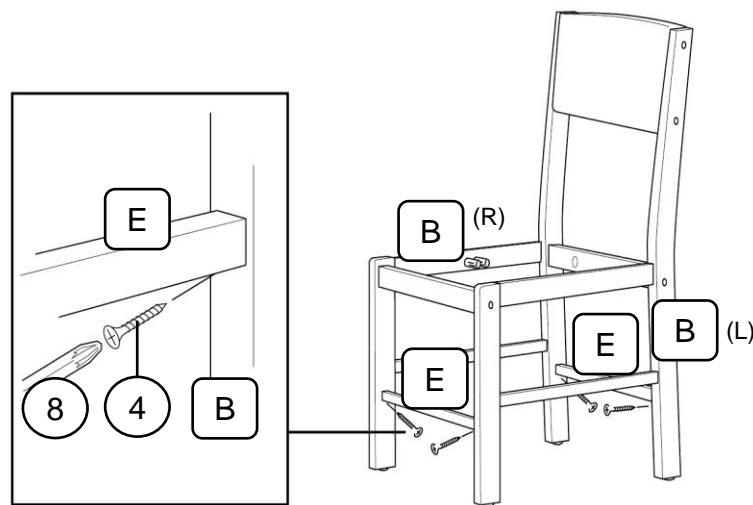

6		Wood Dowel (Cheville en bois)	4pcs
---	---	-------------------------------	------

STEP 6



4		Screw 1/8" x 32mm (Vis Bois Anti)	4pcs	8		CSK Allen Key 4mm (Clé Allen CSK)	1pc
---	---	-----------------------------------	------	---	---	-----------------------------------	-----

STEP 7

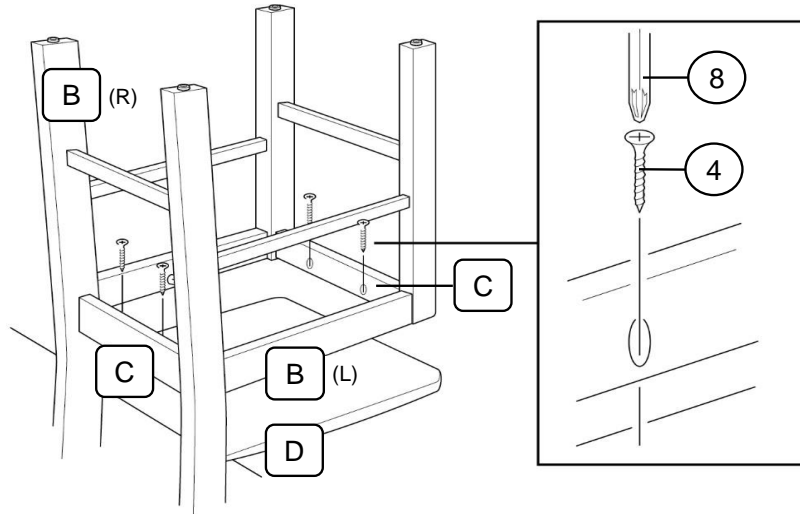

4



Screw 1/8" x 32mm (Vis Bois Anti)

4pcs

8



CSK Allen Key 4mm (Clé Allen CSK)

1pc

STEP 8

