

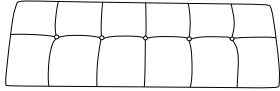

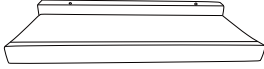







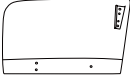



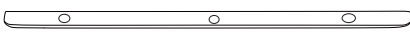

# Instruction

NO	DESCRIPTION			QTY
A	Backrest			1
B1	Seat frame			1
B2	Cushion			2
C	Left handrail			1
D	Right handrail			1
E1	Front leg			2
E2	Posterior left leg			1
E3	Posterior right leg			1
F	Front rung			1
G	Screw1	$\Phi$ 5/16"* 1-9/16"L		6
H	Screw2	$\Phi$ 5/16"* 3-15/16"L		2
I	Screw3	$\Phi$ 1/4"* 1-9/16"L		3
J	Screw4	$\Phi$ 5/16"* 2"L		4
K	Screw5	$\Phi$ 5/16"* 2-3/8"L		4
L	Flat Washer	$\Phi$ 5/16"* 22mm		16
M	Flat Washer	$\Phi$ 1.3mm		3
N	Lock Washer	$\Phi$ 5/16"		16
O	Allen Wrench	$\Phi$ 5mm		1
P	Allen Wrench	$\Phi$ 4mm		1

# Installation Method

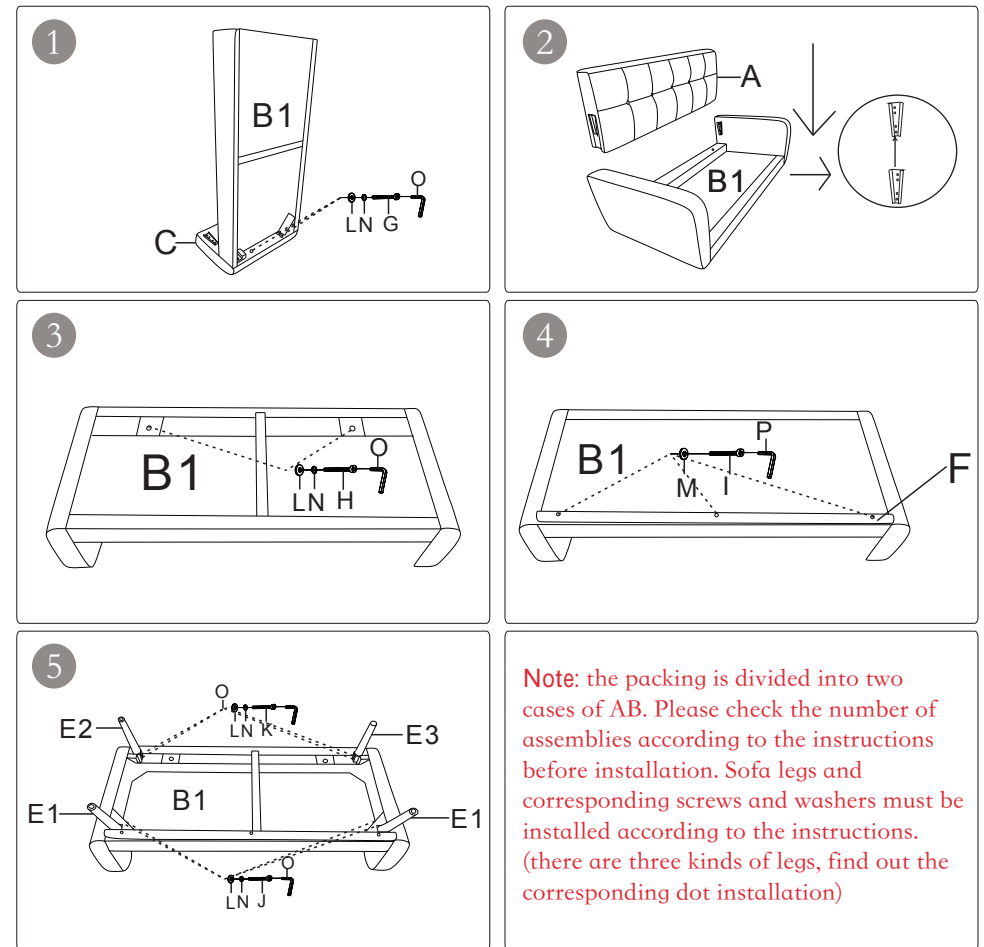

- 1 Install the left handrail (C) and right handrail (D) on both sides of the seat frame (B1) with screws (G), as shown. Three screws are needed on each side.
- 2 Install the backrest (A) on the seat frame (B1). Aim the backrest (A) at the rails on the left and right sides and press as shown.
- 3 Flip the assembled backrest and fix the two holes at the bottom of the seat frame and the backrest with screws (H).
- 4 Secure the front rung (F) with screws (I).
- 5 Insert the four legs into the corresponding hole position and secure them with screws and washers. As shown in the figure.
- 6 Finally, turn the assembled sofa over, tear off the Velcro at the bottom of the cushion (B2) and place it.

**Note:** the packing is divided into two cases of AB. Please check the number of assemblies according to the instructions before installation. Sofa legs and corresponding screws and washers must be installed according to the instructions. (there are three kinds of legs, find out the corresponding dot installation)

# Instruction Manual

## User Guide

### Make life better

Warm tips: We are proud of high-quality products and satisfactory service, but the goods may encounter special circumstances during transportation, if you receive the goods with missing or damaged parts, please take photos and contact our customer service before returning the goods , we will customize a solution that satisfies you, thank you.

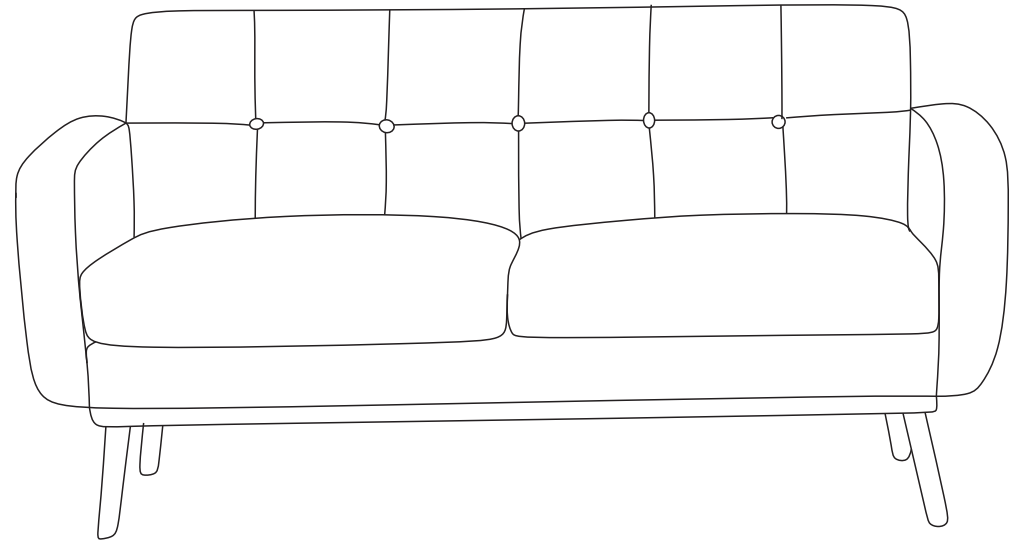

#### Note:

1. During the assembly process of a product, if you need to install multiple screws, you can first align all the screws with the holes, first rotate a few times to fix the positions of all the screws, and after all the screws are aligned with the holes, use a wrench to completely tighten in turn.
2. Flat washers and lock washers must be installed to prevent the screws from loosening and damaging the joints.

**LOVESEAT**