

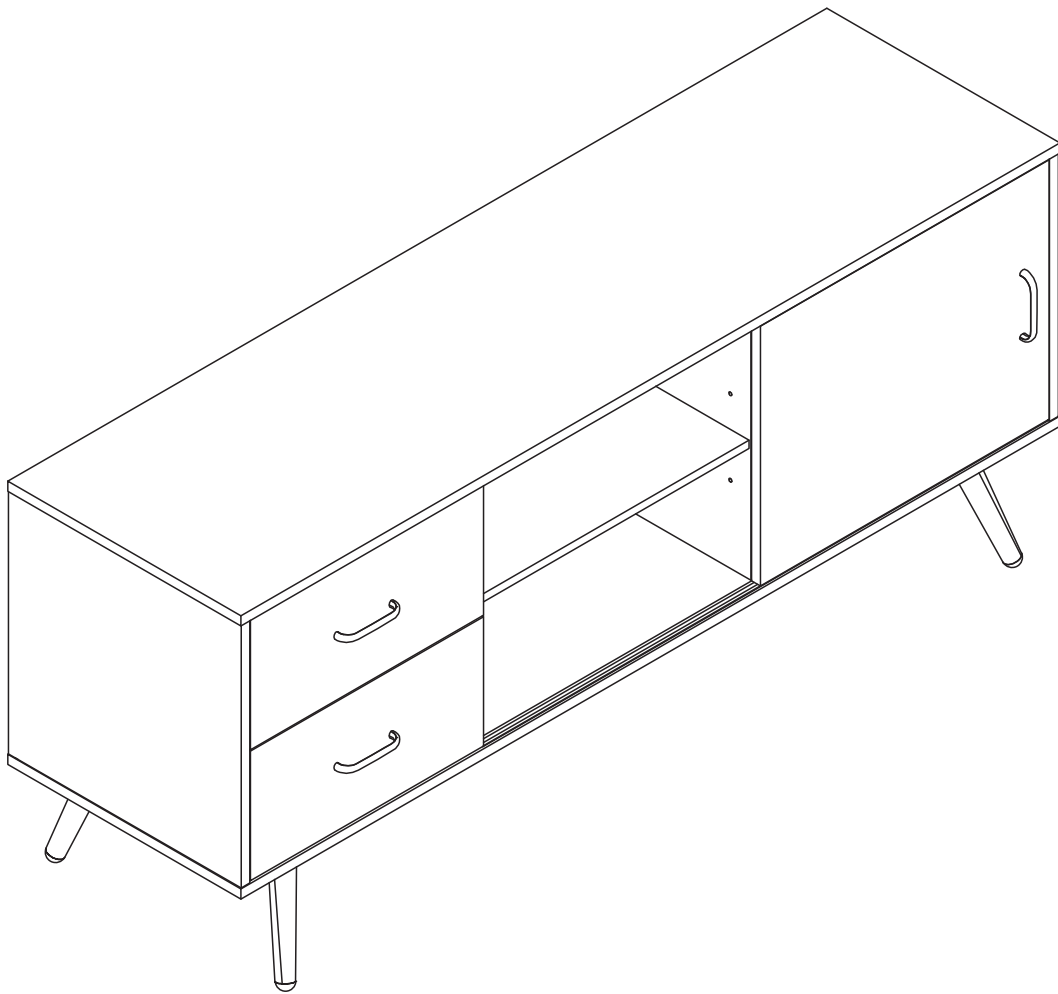

**YEAR COLOR**  
— As You Grow



HMC-MW-051 V1.0

**TV Cabinet**

**EN**

Thank you for purchase on YEARCOLOR products. Please contact us if you have difficulty with assembly or need replacement parts. YEARCOLOR customer service is here to assist you.

Email: yearcolor@yahoo.com

Please attach your User Name or Order ID so that we can assist you better.

## **WARNING**

Serious or fatal injury may occur from unexpected assembly or use.

1. During the assembly process, keep all parts away from babies or children.
2. Use of tip-over restraints may only reduce, but not eliminate the risk of tip-over.
3. Unless specially designed to accommodate, do not set heavy objects on top of this product.
4. Place the heaviest items on the lowest shelf.
5. Never allow children to climb or bang on drawers, doors or shelves.

**DE**

Vielen Dank für Ihren Kauf von YEARCOLOR Produkten. Bitte kontaktieren Sie uns, wenn Sie Probleme mit Montage haben oder Ersatzteile benötigen. YEARCOLOR Kundenservice ist für Sie da.

Email: yearcolor@yahoo.com

Bitte geben Sie Ihren Benutzernamen oder Ihre Bestellnummer an, damit wir Sie besser unterstützen können.

## **WARNUNG**







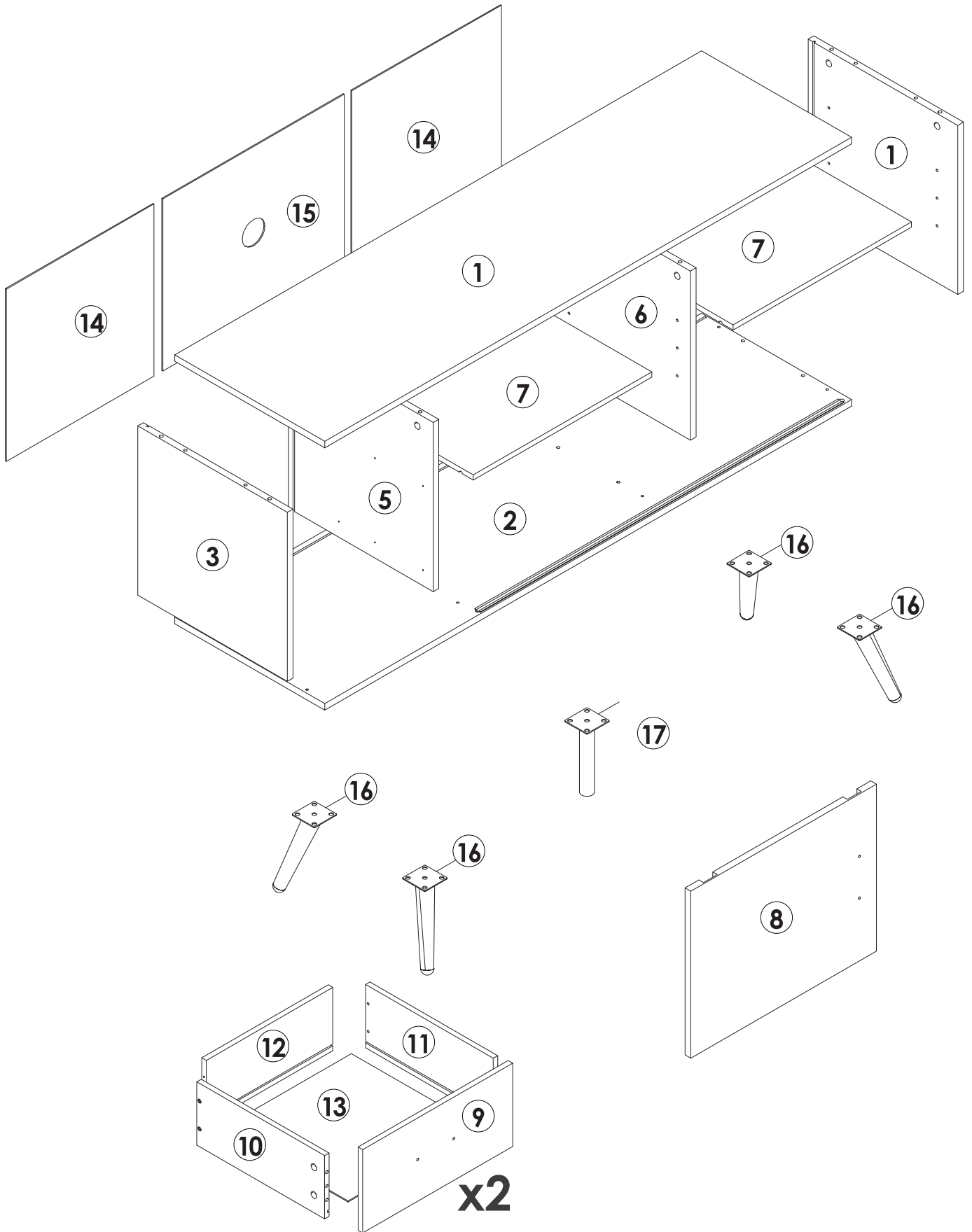

Bei unerwarteter Montage oder Verwendung können schwere oder tödliche Verletzung auftreten.

1. Legen Sie in den Montageprozess alle Teile weg von Babys oder Kindern.
2. Die Verwendung von Kippsicherungen kann die Gefahr eines Kippens nur verringern, jedoch nicht beseitigen.
3. Setzen Sie bitte keine schweren Gegenstände auf dieses Produkt, es sei denn, dass das Produkt speziell für die Unterbringung konzipiert wird.
4. Legen Sie bitte die schwersten Gegenstände auf das unterste Regal.
5. Erlauben Sie nie Kindern, auf Schubladen, Türen oder Regale zu klettern oder zu knallen.

# Parts List(EN) / Teile Liste(DE)

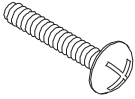
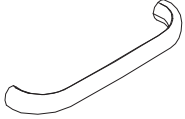
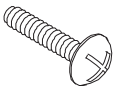
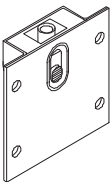
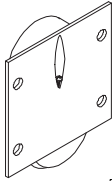

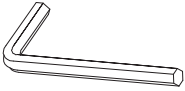
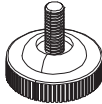

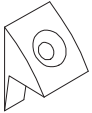
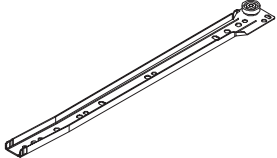
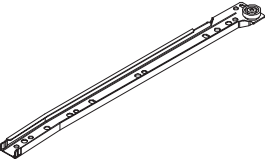
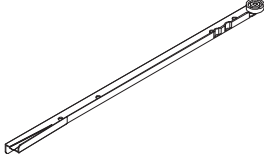
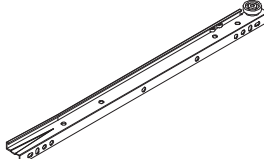

## Parts List(EN) / Teile Liste(DE)

<p><b>A</b></p>  <p>M6x35mm      16PCS</p>	<p><b>B</b></p>  <p>Φ15x9.5mm      16PCS</p>	<p><b>C</b></p>  <p>M4x40mm      16PCS</p>
<p><b>D</b></p>  <p>Φ6x30mm      20PCS</p>	<p><b>E</b></p>  <p>M3x12mm      24PCS</p>	<p><b>F</b></p>  <p>M4x18mm      2PCS</p>
<p><b>G</b></p>  <p>96mm      3PCS</p>	<p><b>H</b></p>  <p>M4x16mm      4PCS</p>	<p><b>I</b></p>  <p>2PCS</p>
<p><b>J</b></p>  <p>2PCS</p>	<p><b>K</b></p>  <p>8PCS</p>	<p><b>L</b></p>  <p>M6x12mm      20PCS</p>
<p><b>M</b></p>  <p>M4      1PC</p>	<p><b>N</b></p>  <p>Φ6mm      1PC</p>	<p><b>O</b></p>  <p>Φ20mm      4PCS</p>
<p><b>P</b></p>  <p>M3x14mm      28PCS</p>	<p><b>Q</b></p>  <p>Φ15x9.5mm      12PCS</p>	<p><b>CL</b></p>  <p>L350mm      2PCS</p>
<p><b>CR</b></p>  <p>L350mm      2PCS</p>	<p><b>DL</b></p>  <p>L350mm      2PCS</p>	<p><b>DR</b></p>  <p>L350mm      2PCS</p>

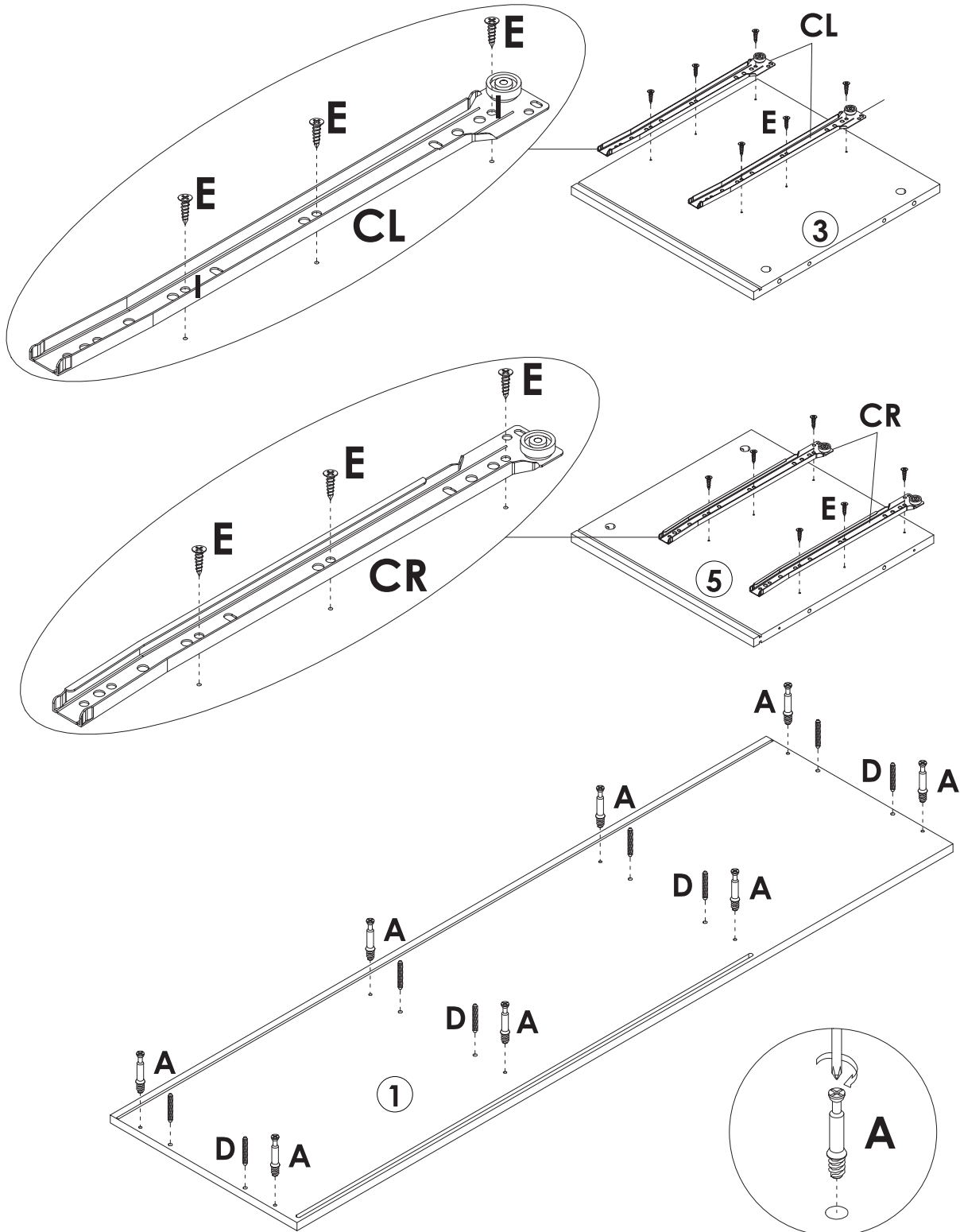
# Assembly Steps(EN) / Montageschritte(DE)

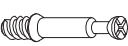
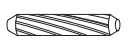
## STEP 1



	<b>A</b> x 8PCS
	<b>D</b> x 8PCS
	<b>E</b> x 12PCS
	<b>CL</b> x 2PCS
	<b>CR</b> x 2PCS

# Assembly Steps(EN) / Montageschritte(DE)

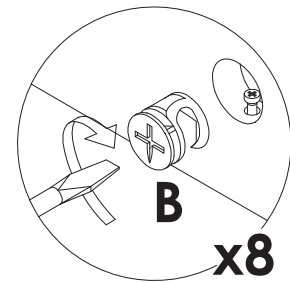
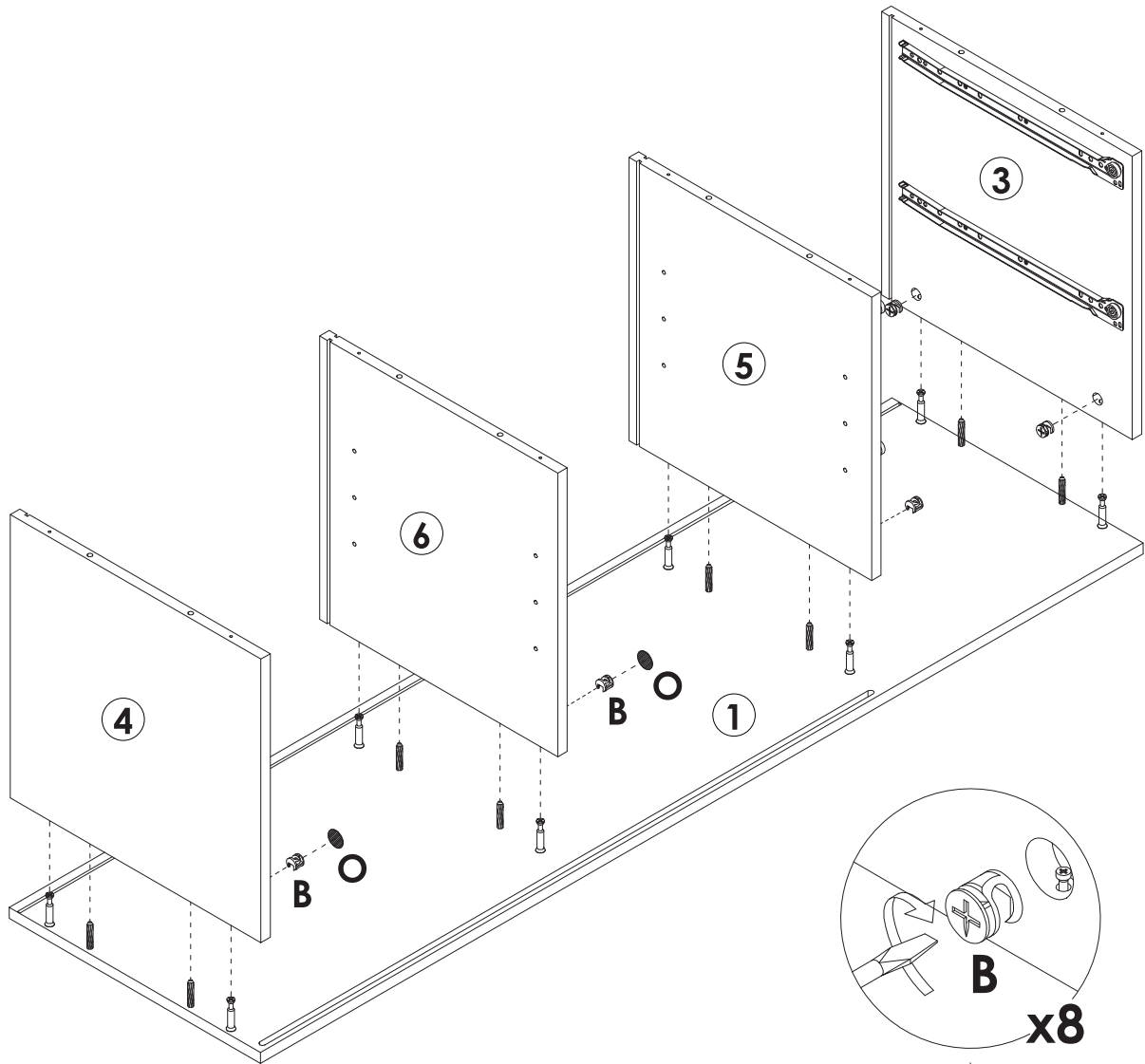

## STEP 2

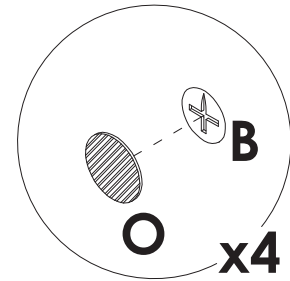

**x8**



**x4**

	<b>B</b> x 8PCS
	<b>O</b> x 4PCS

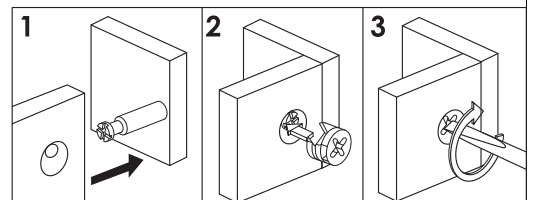

# Assembly Steps(EN) / Montageschritte(DE)

## STEP 3

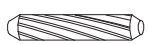
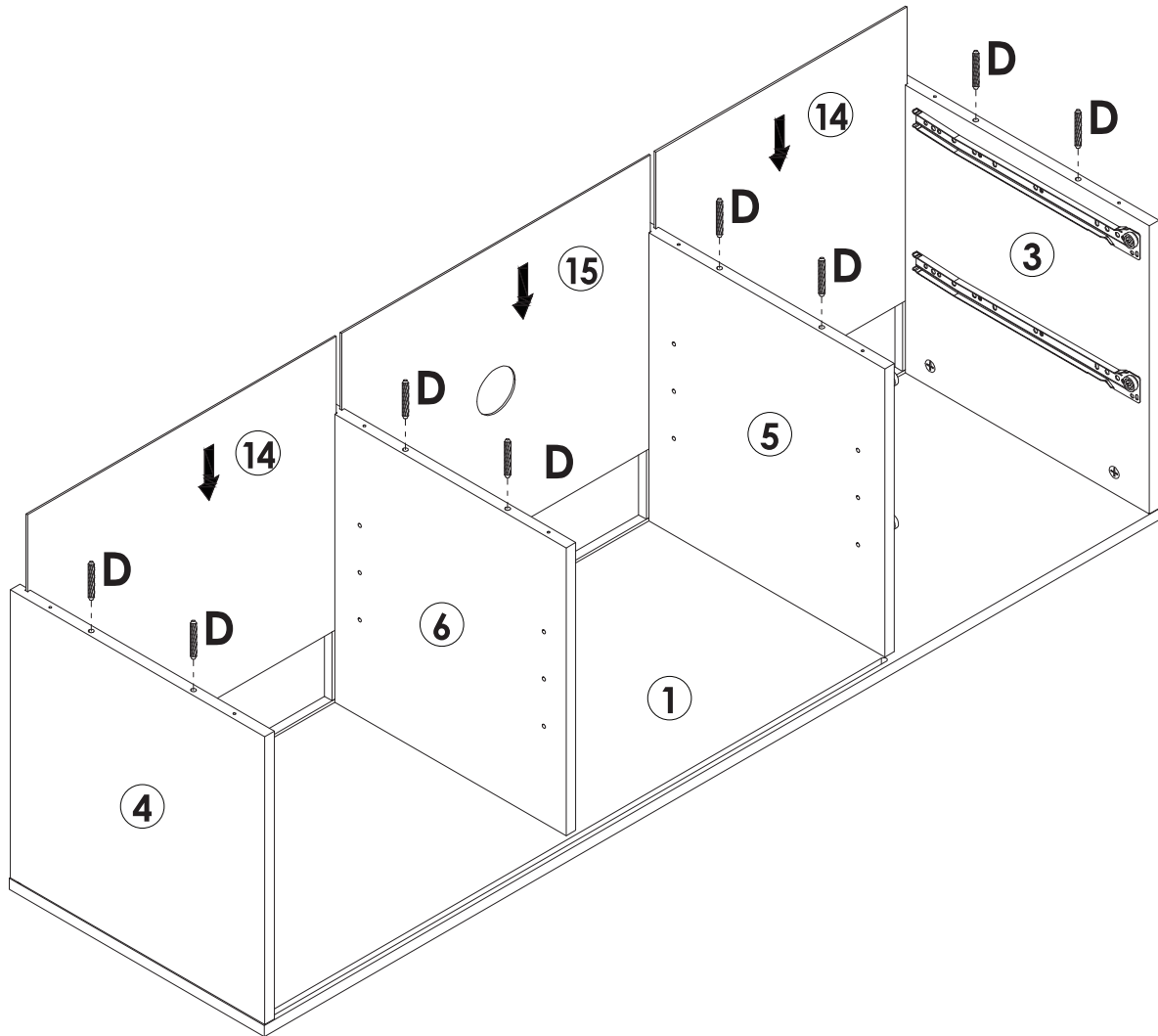

**D** x 8PCS

# STEP 4

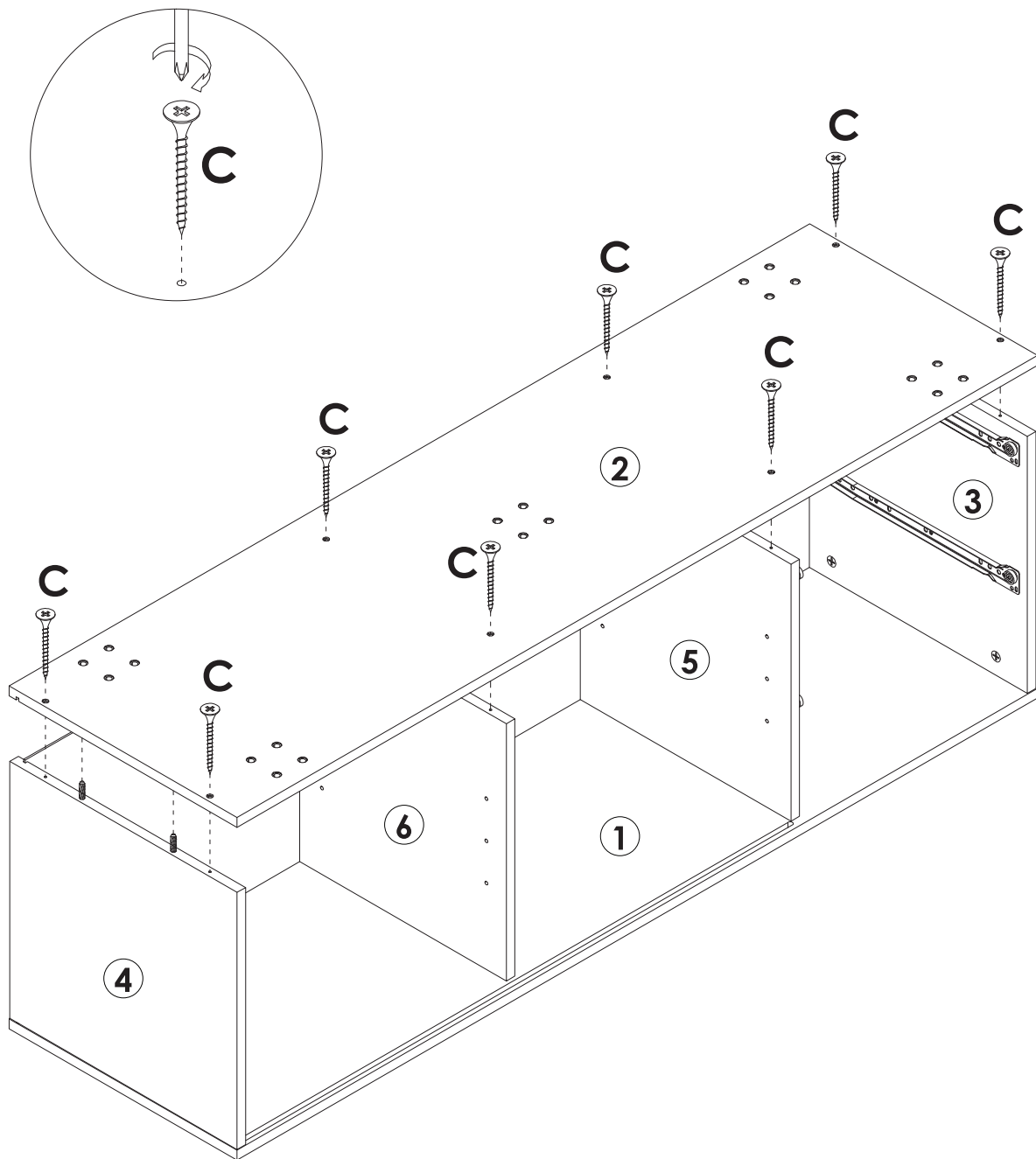



C x 8PCS

# Assembly Steps(EN) / Montageschritte(DE)

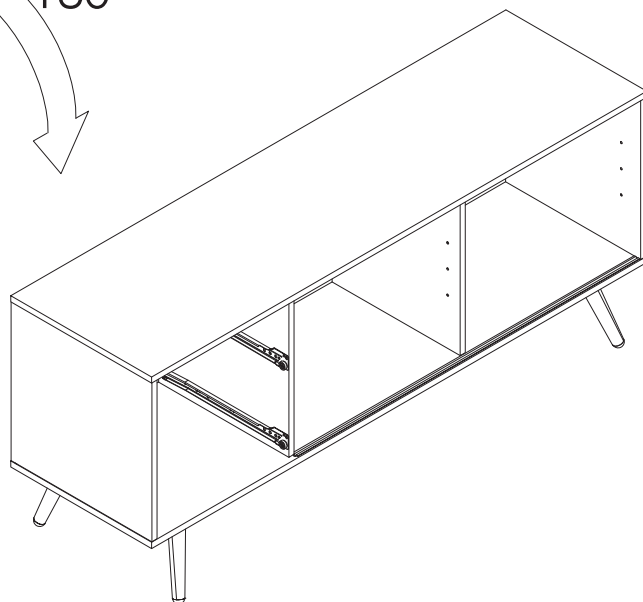
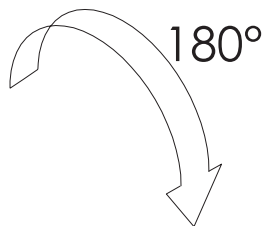
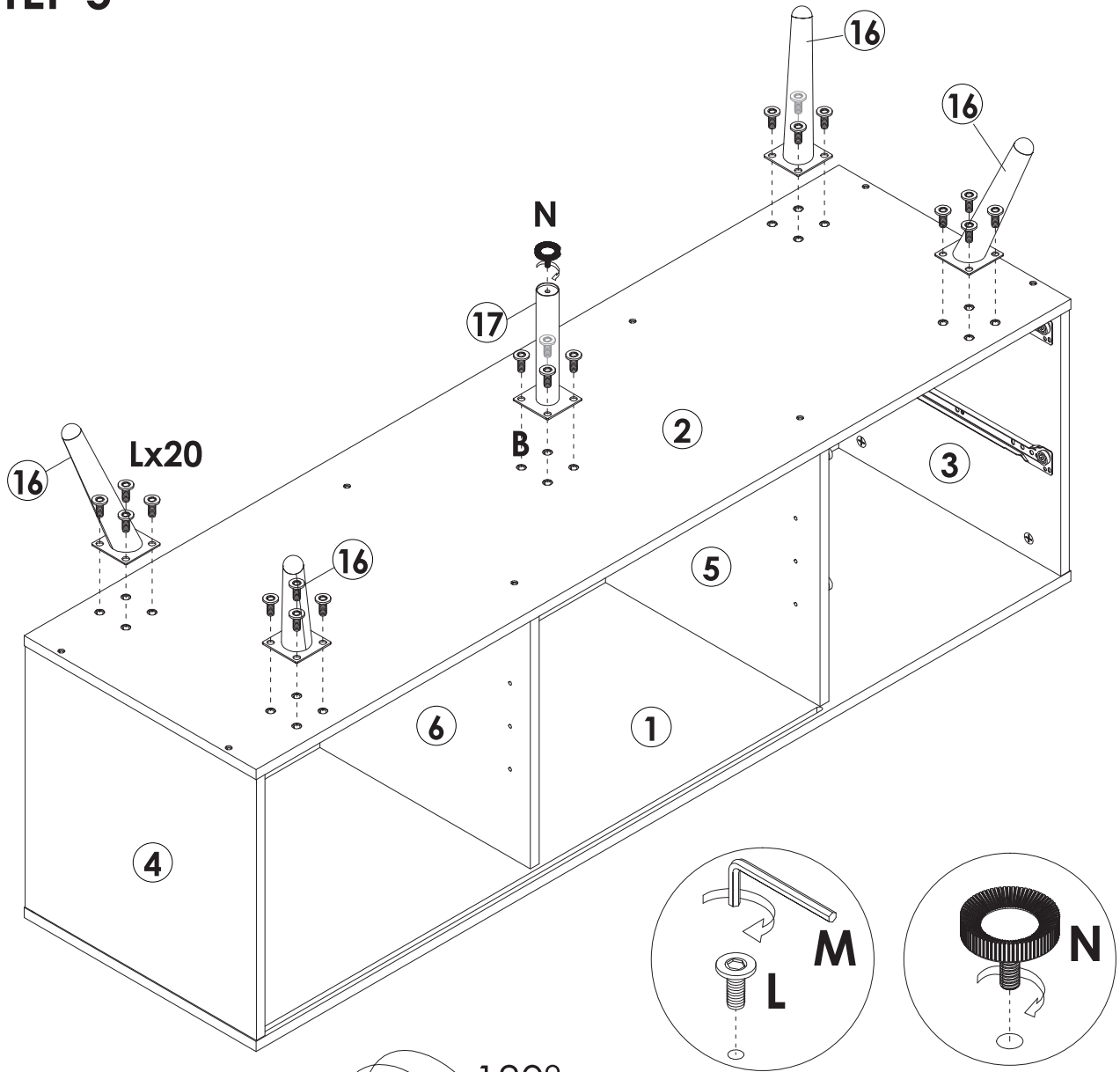
## STEP 5





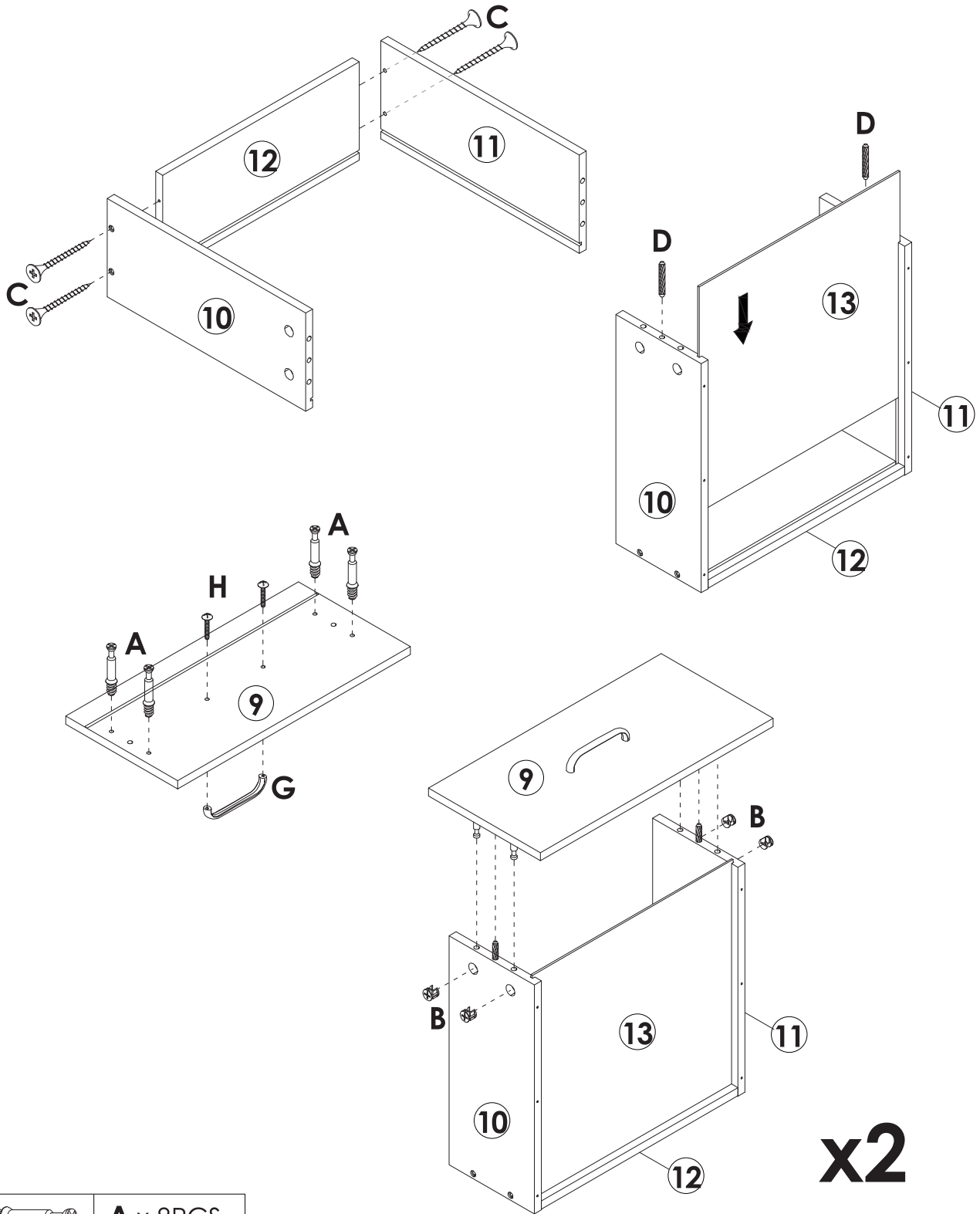

	<b>L</b> x 20PCS
	<b>M</b> x 1PC
	<b>N</b> x 1PC

# Assembly Steps(EN) / Montageschritte(DE)

## STEP 6

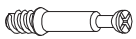

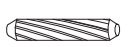
**x2**

	<b>A</b> x 8PCS
	<b>B</b> x 8PCS
	<b>D</b> x 4PCS
	<b>G</b> x 2PCS
	<b>H</b> x 4PCS

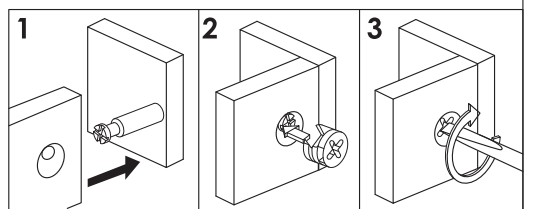

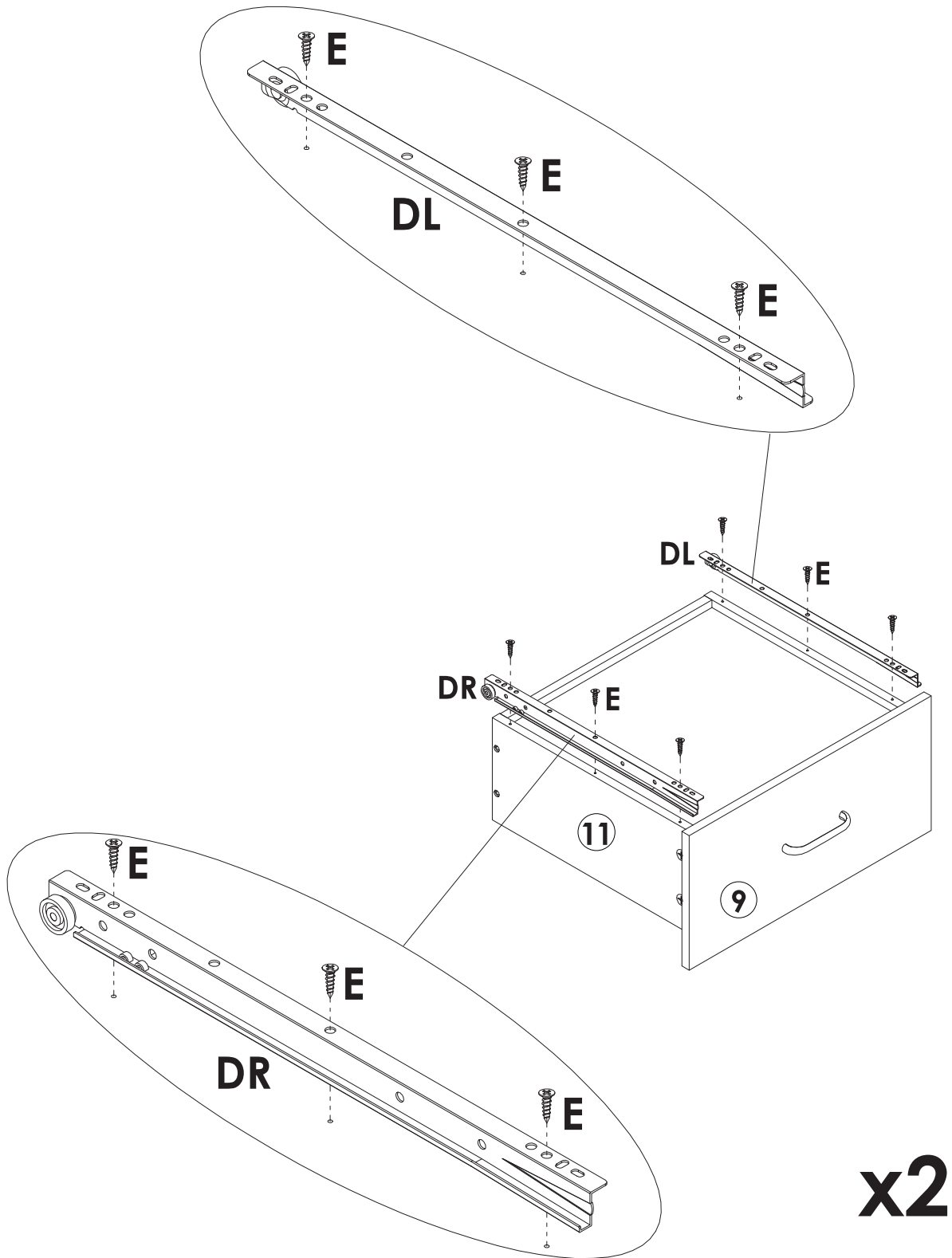

# Assembly Steps(EN) / Montageschritte(DE)

## STEP 7



**x2**

	<b>E x 12PCS</b>
	<b>DL x 2PCS</b>
	<b>DR x 2PCS</b>

# Assembly Steps(EN) / Montageschritte(DE)

## STEP 8

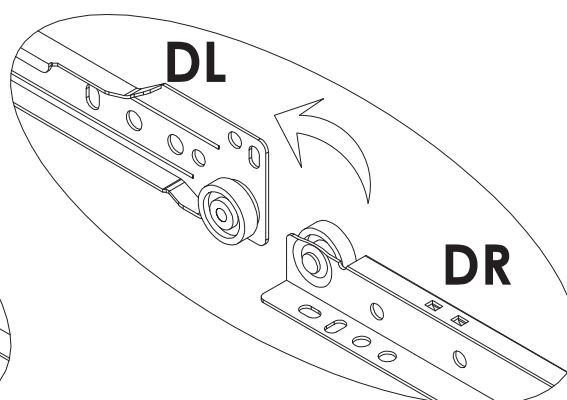
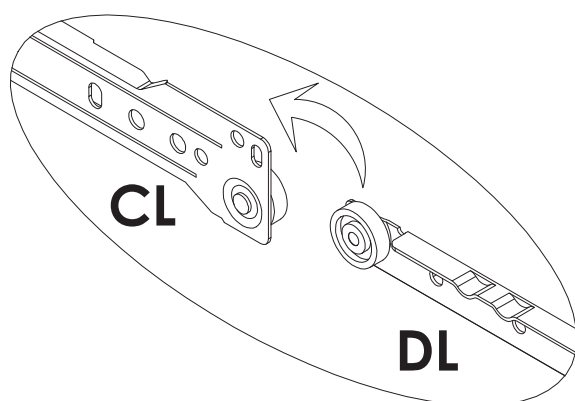
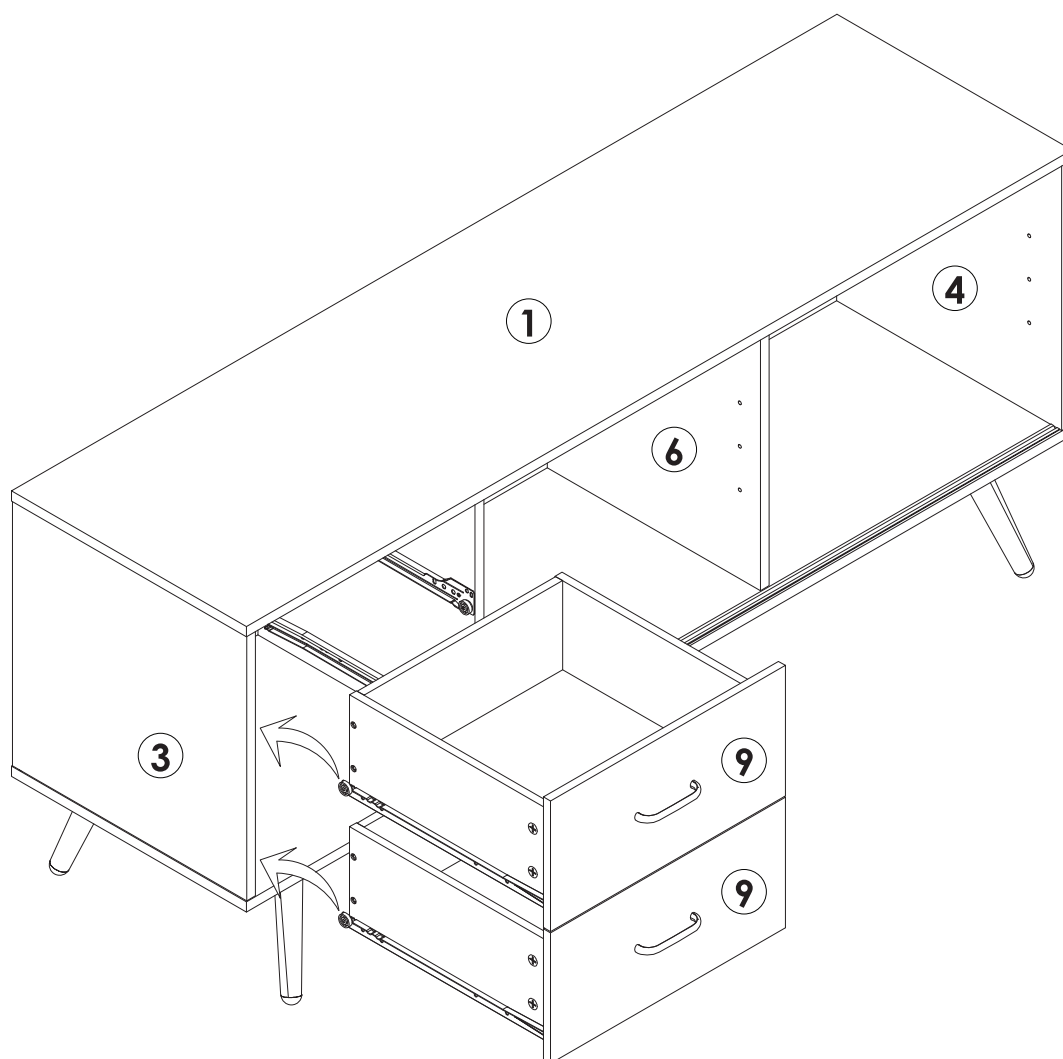

**STEP 9**

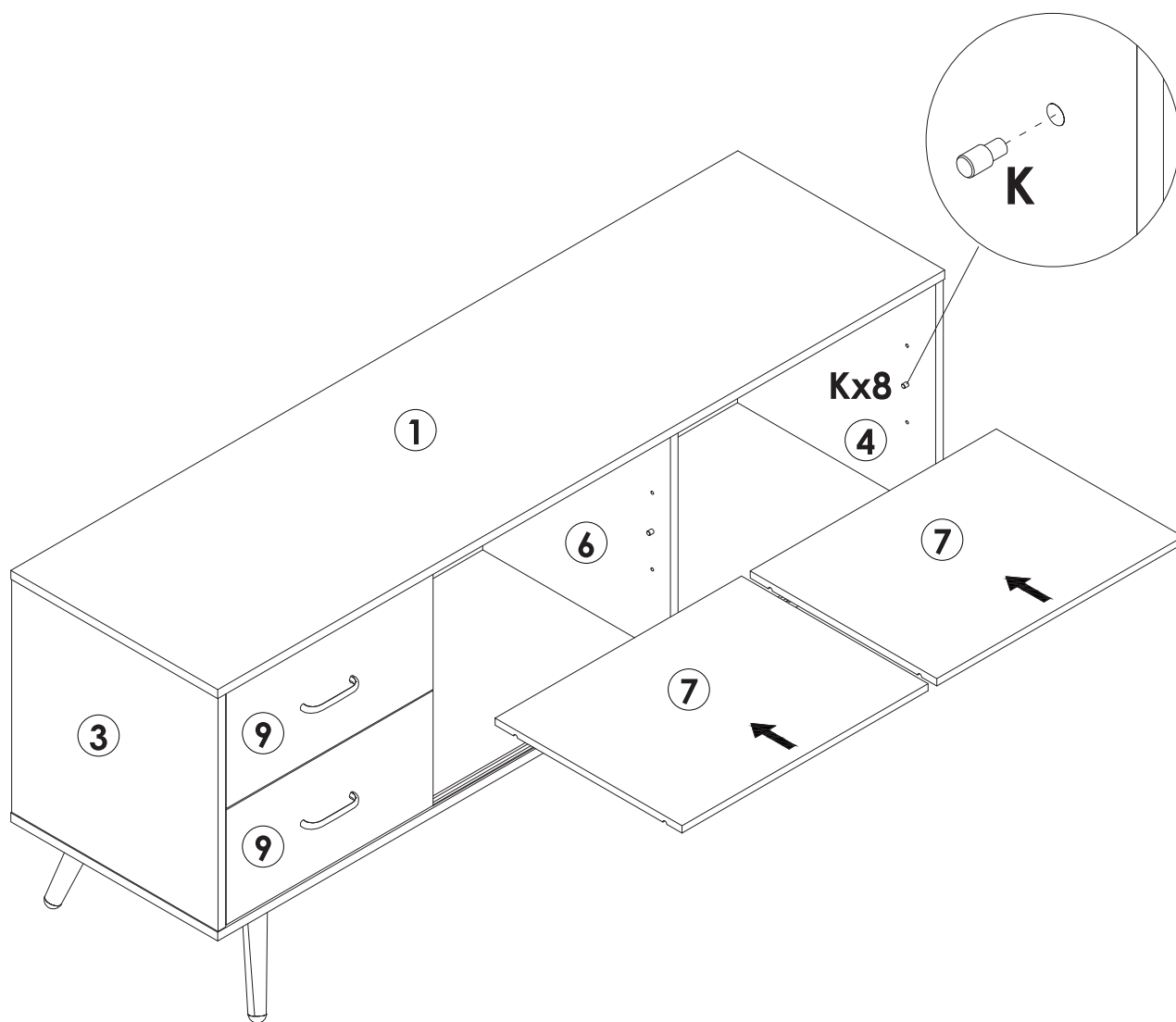



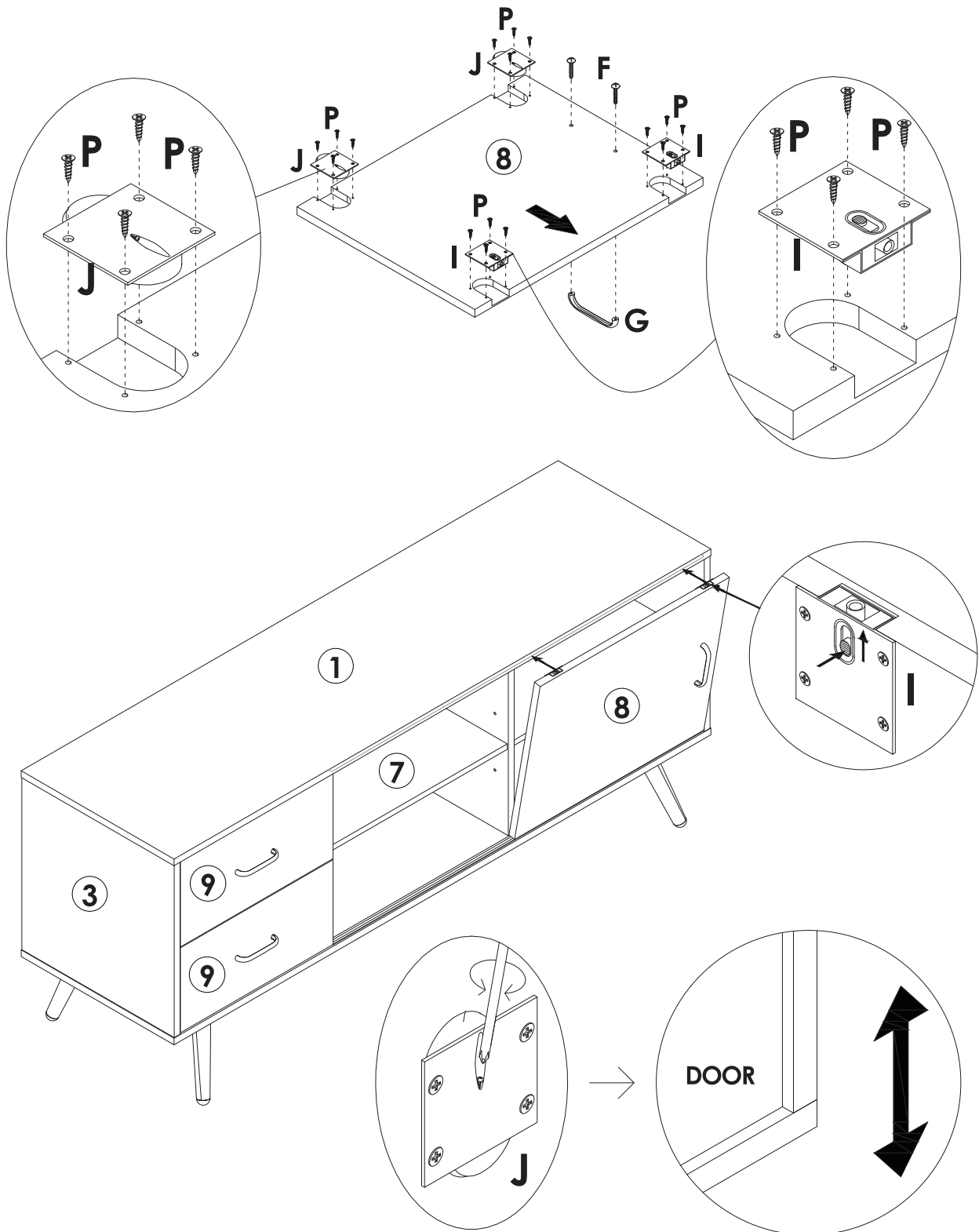

**K x 8PCS**

# Assembly Steps(EN) / Montageschritte(DE)

## STEP 10





	<b>F</b> x 2PCS
	<b>G</b> x 1PC
	<b>I</b> x 2PCS
	<b>J</b> x 2PCS
	<b>P</b> x 16PCS

**Note:** Dear customer, if the door sliding is too tight, please adjust this screw to improve. The door will gradually get loose and smooth with usage.

# Assembly Steps(EN) / Montageschritte(DE)

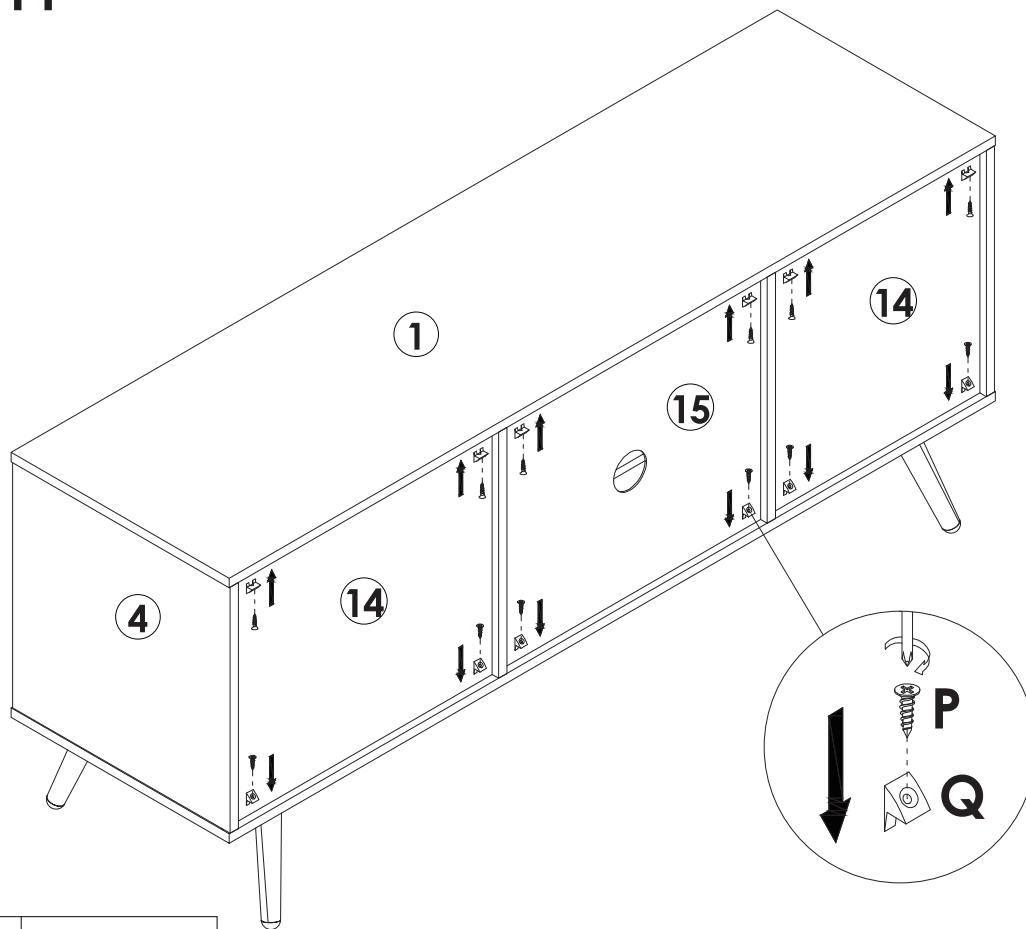
## STEP 11



	<b>P</b> x 12PCS
	<b>Q</b> x 12PCS

## STEP 12

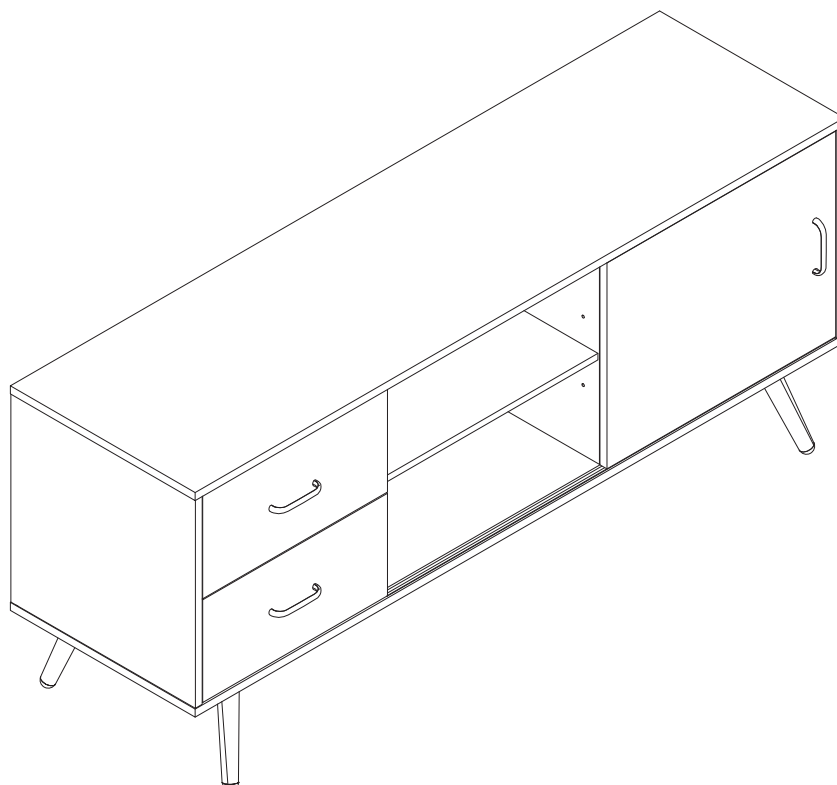



**YEAR COLOR**  
— As You Grow

Company: Year Color Usa Inc

Address: 4205 Trotters Way Ste A Alpharetta, Ga 30004

E-mail: [yearcolor@yahoo.com](mailto:yearcolor@yahoo.com)