

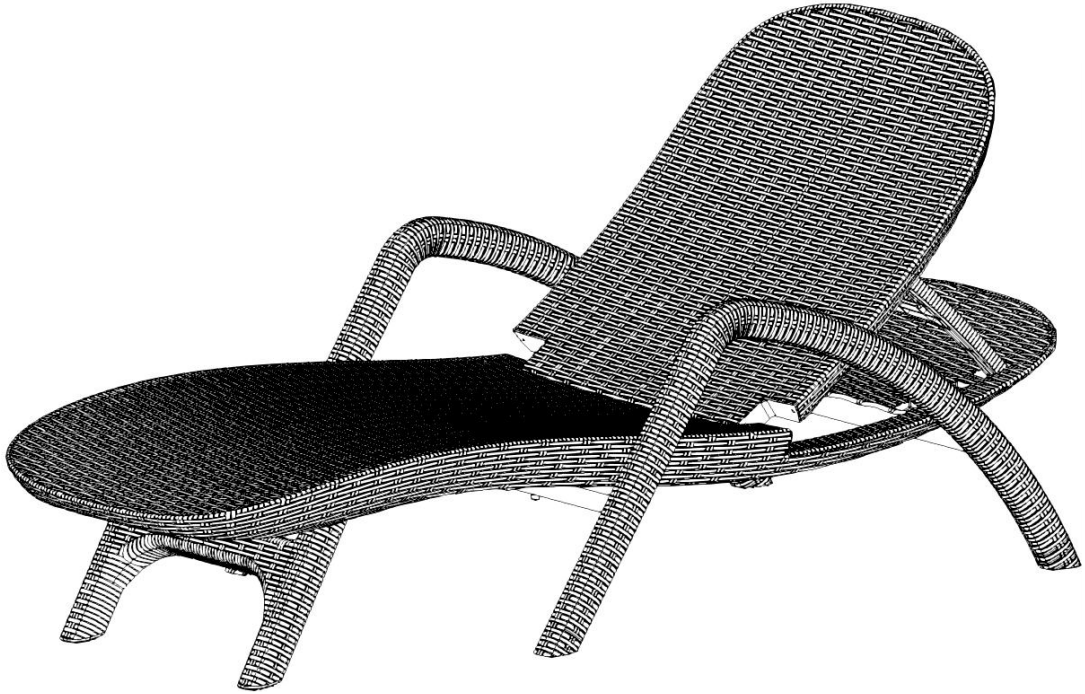











# ASSEMBLY INSTRUCTIONS



## CHAISE LOUNGE

# CHAISE LOUNGE ASSEMBLY PARTS

DESCRIPTION	IMAGE	QTY
Head Area of Body (Pre-assembly)		1
Foot Area of Body (Pre-assembly)		1
Left Armrest		1
Right Armrest		1
Plastic Screw		2
Plastic Wrench		1
Metal Tube		2
Bolt(M8*45mm)		5
Bolt(M6*16mm)		18
Allen Key(M8)		1
Allen Key(M6)		1

\*Note: Recommended for two people to finish the assembly.

**1**

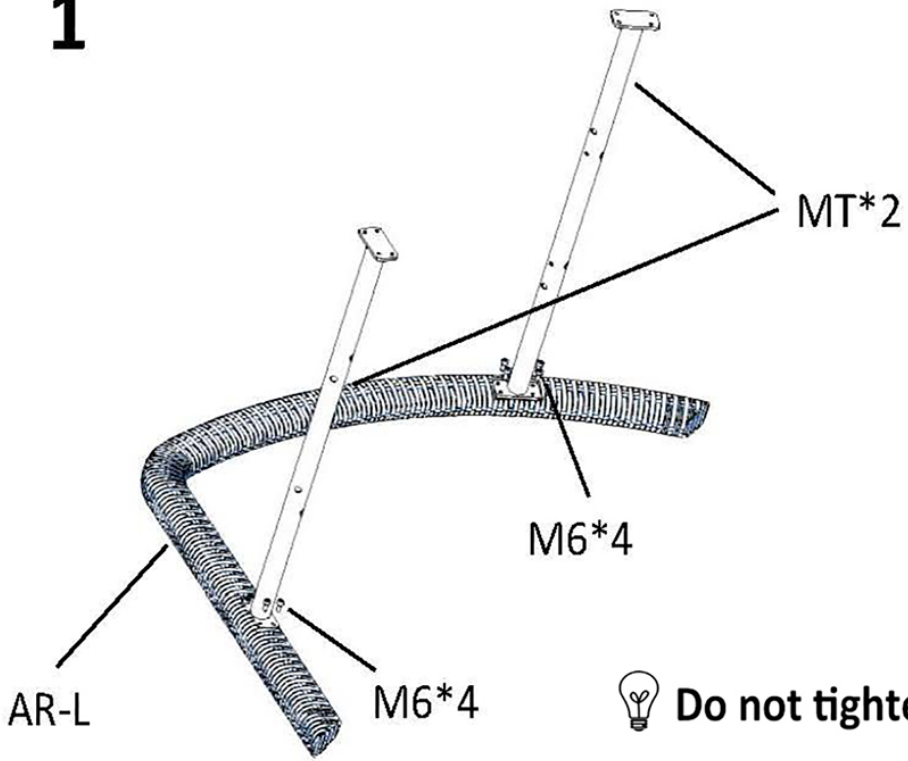

 **Do not tighten the bolts!!**

**2**

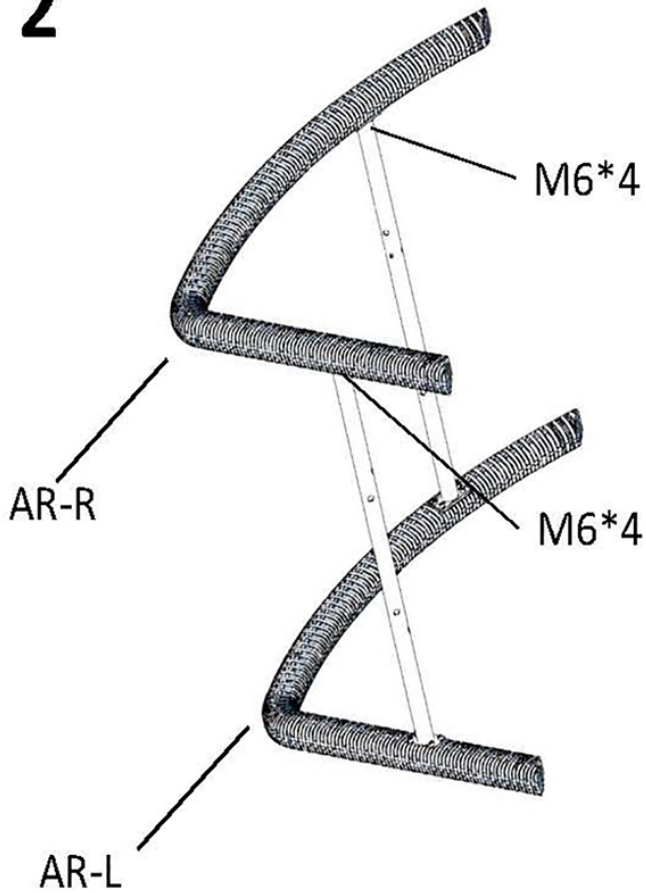

 **Tighten the bolts when all bolts lines up!!**

**3**

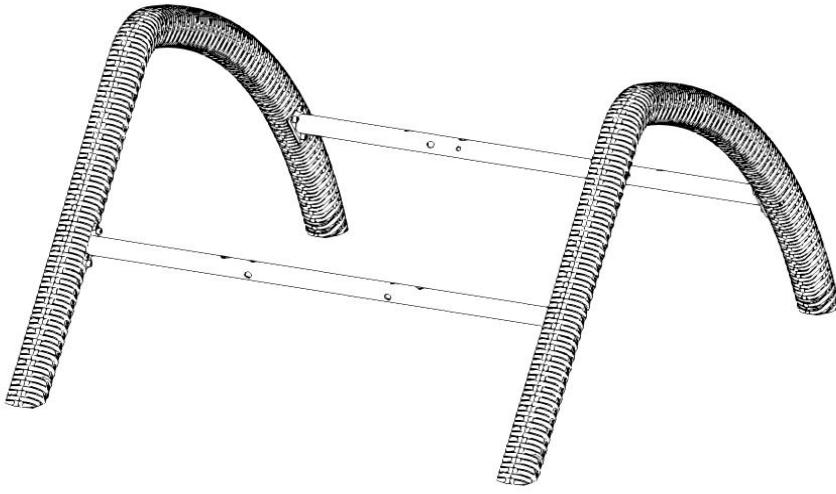

**4**

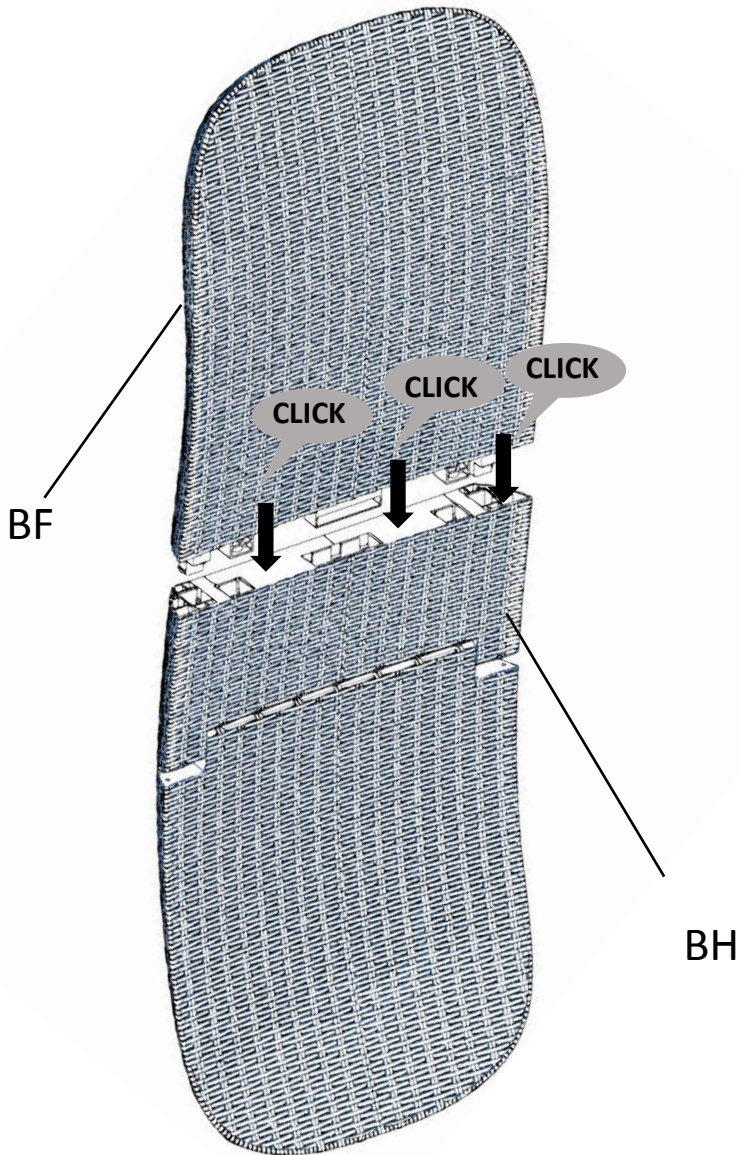

5

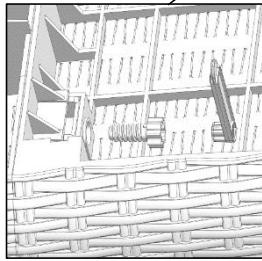
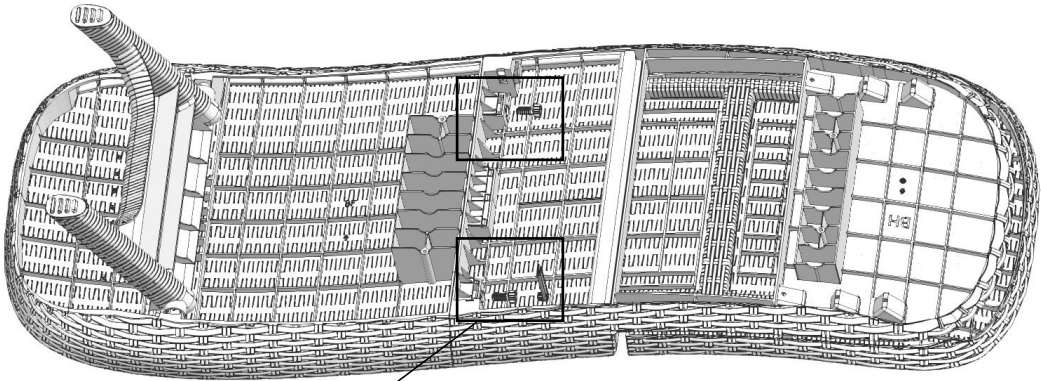

PS\*2

6

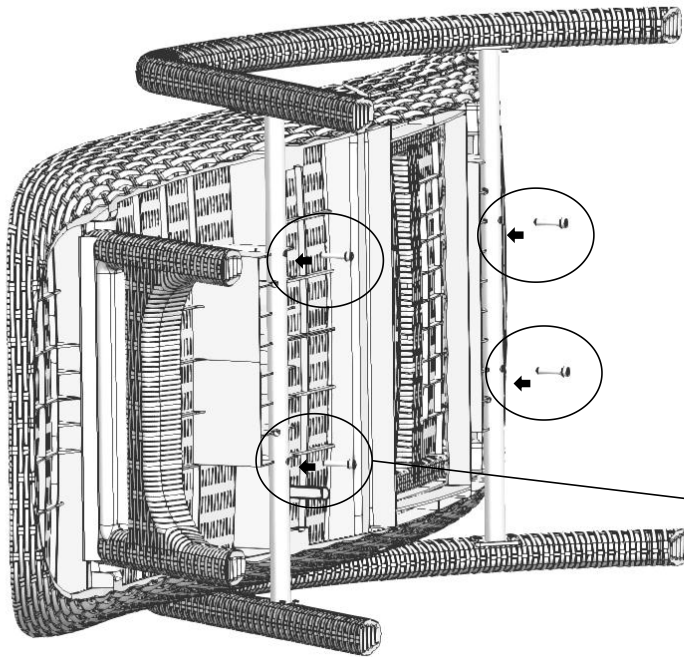



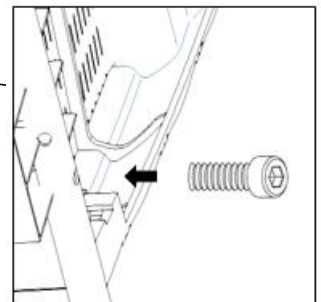



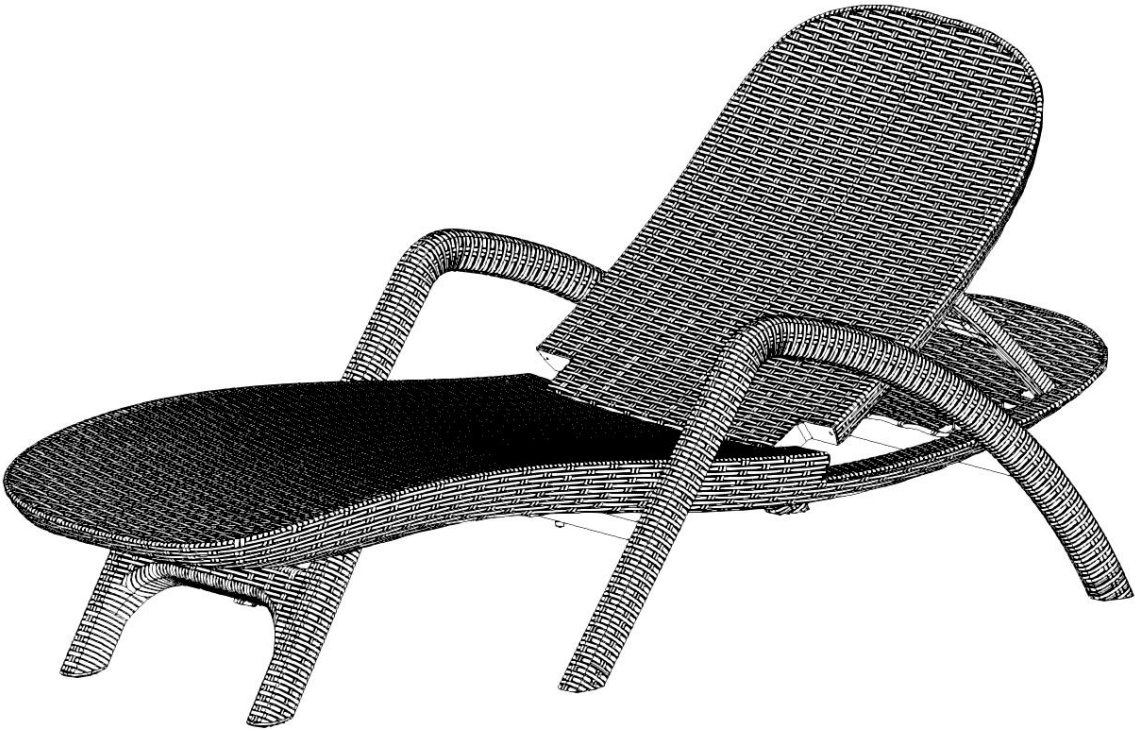



M8\*4



7



## Care & Maintenance

- ⊘  ● Prolonged exposure to rain may cause rusting which can stain floors.
- ⊘  ● Do not put hot items directly on furniture surface.
- ⊘  ● Do not clean furniture with harsh cleansers or polish.
- ✓  ● To obtain the longest lifespan of your outdoor products, minimizing exposure to direct sunlight is recommended.
- ⊘  ● Children should not climb or jump on the furniture.
- ⊘  ● Do not write on furniture without a padded barrier to protect the surface.
- ✓  ● To obtain the longest lifespan of your outdoor products, avoid extended and lengthy exposure to rain, snow, and direct sunshine. Whenever possible cover the product and /or place under patio or awnings.
- ⊘  ● Not for commercial use. For residential use only.
- ⊘  ● Stains may be removed with mild soap solution and damp cloth.
- ✓  ● Keep away from sources of ignition.
- ✓  ● Dust and pick-up spills using a clean, non-colored, lint-free cloth.