

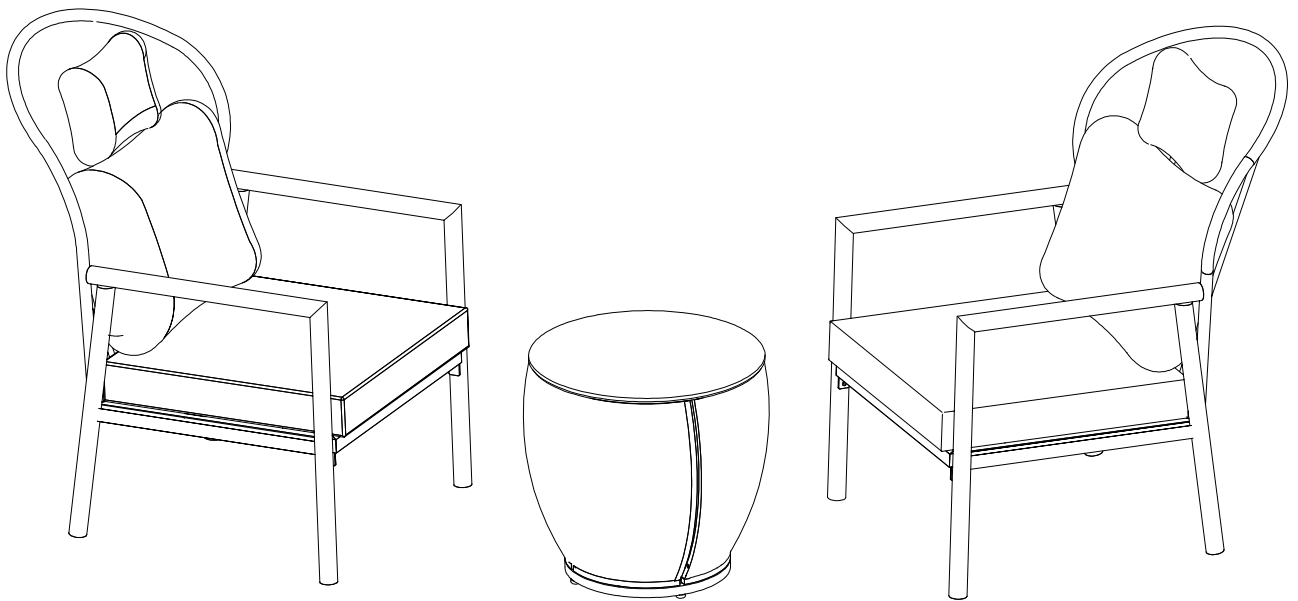





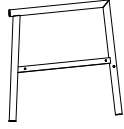
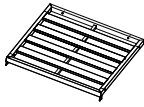
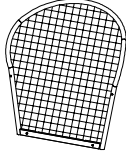

ASSEMBLY INSTRUCTION

Sofa Set

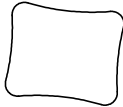

Component List

LABEL		DESCRIPTION	QTY
A		Left Armrest/Leg	2
B		Right Armrest/Leg	2
C		Seat Frames	2
D		Back Frames	2
E		Table Top	1
F		Table Legs	4
G		Bottom Ring	1
H		Seat Cushions	2
I		Big Back Cushions	2
J		Small Back Cushions	2

Hardware List

LABEL		DESCRIPTION	QTY
①	 M6*15	Bolts	4
②	 M6*35	Bolts	24
③	 M6*45	Bolts	4
④	 M6	Washers	40
⑤	 M6	Nuts	8
⑥	 M6	Allen Wrench	1
⑦	 M6	Wrench	1

1

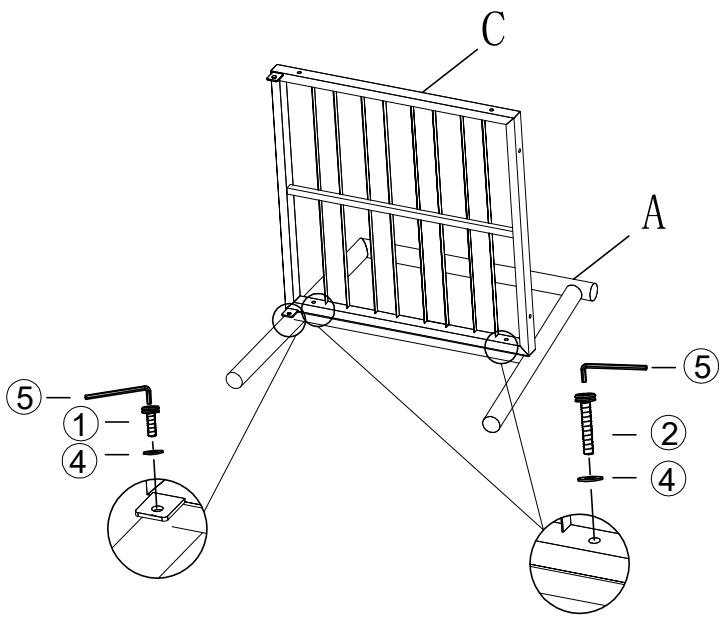
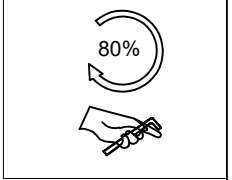
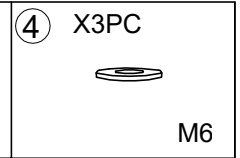
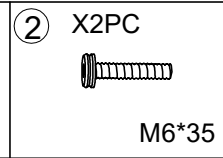
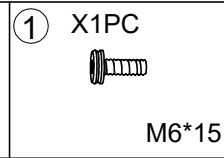
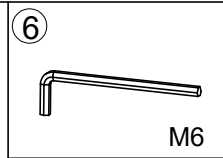

2

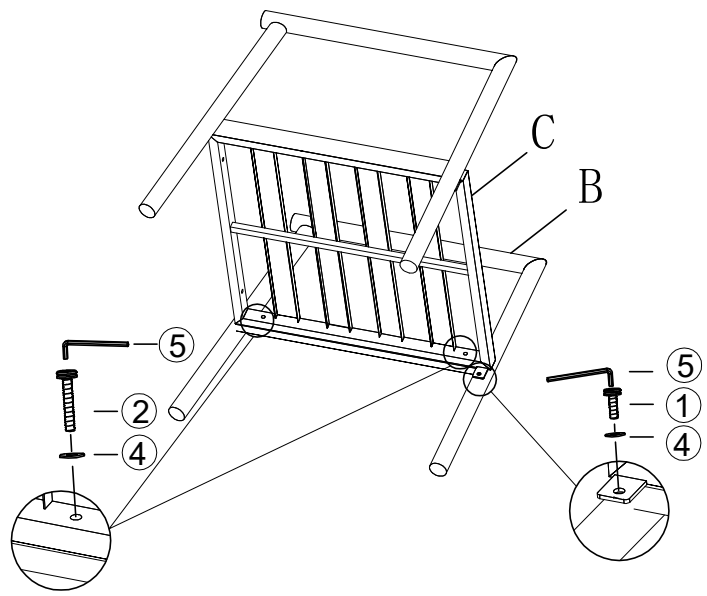
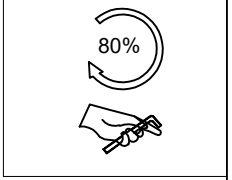
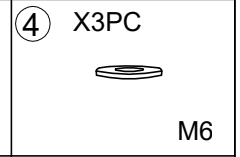
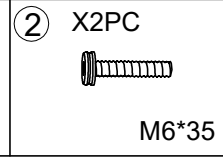
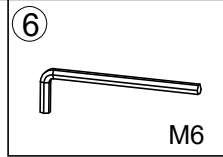

3

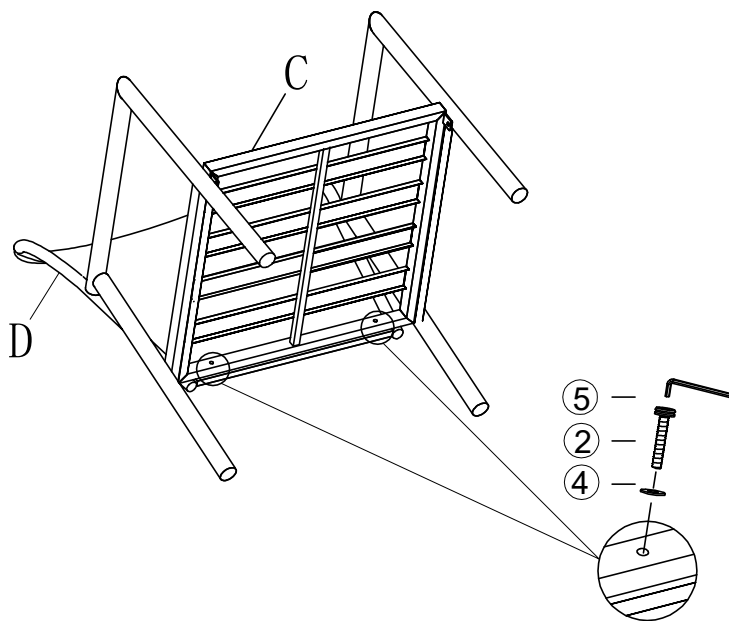
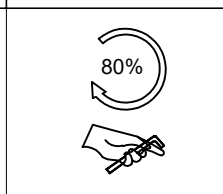
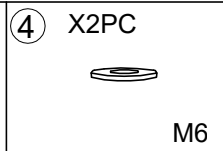
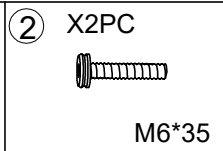
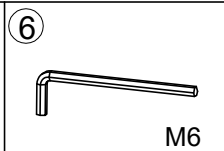

4

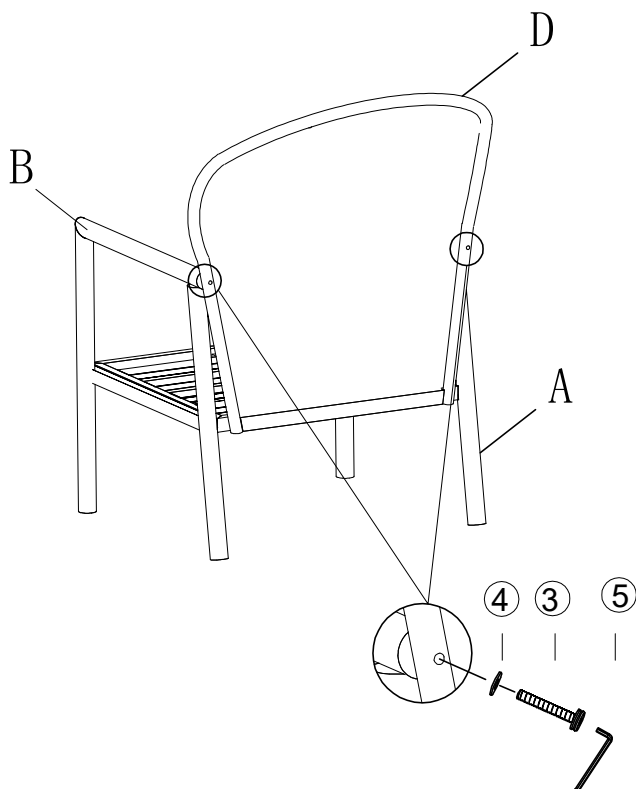
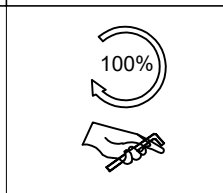
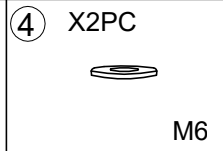
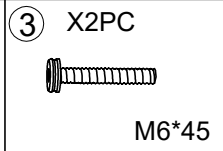
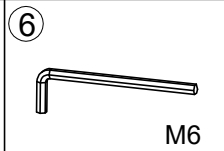



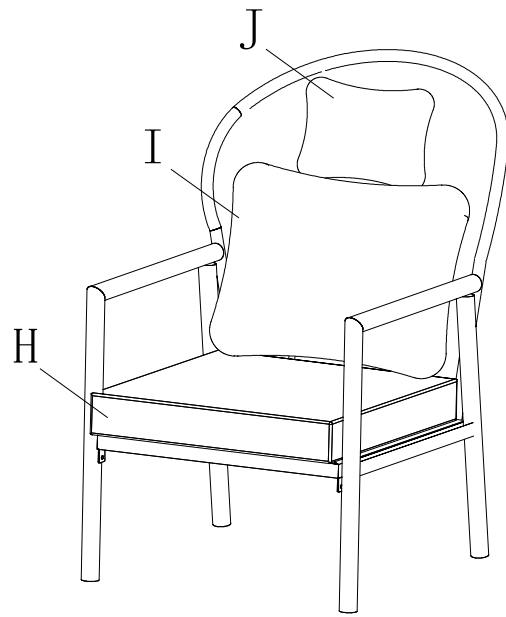

Fully tighten all bolts on this step!

5

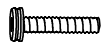

2PCS

6

<p>⑥</p>  <p>M6</p>	<p>⑦</p>  <p>M6</p>	<p>⑤ X2PC</p>  <p>M6</p>	<p>② X2PC</p>  <p>M6*35</p>	<p>④ X4PC</p>  <p>M6</p>
--	--	--	--	---

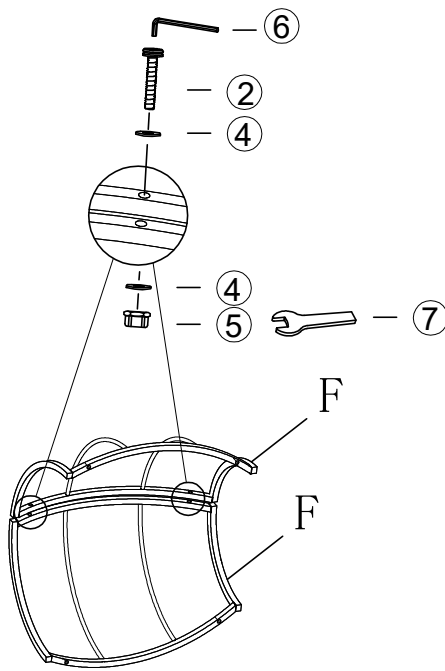
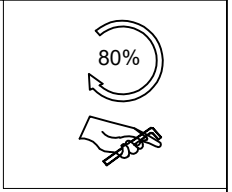

7

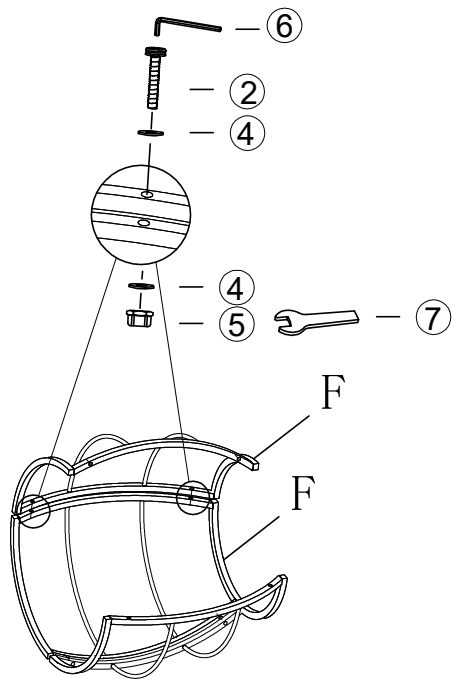
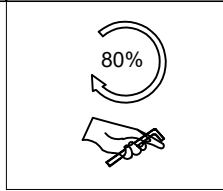
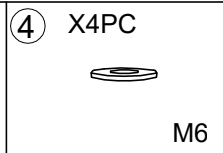
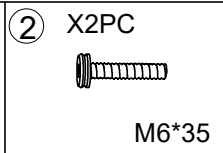
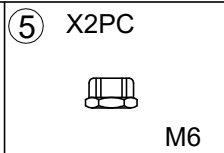
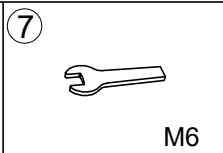
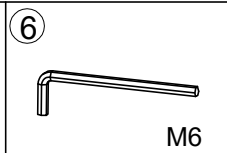

8

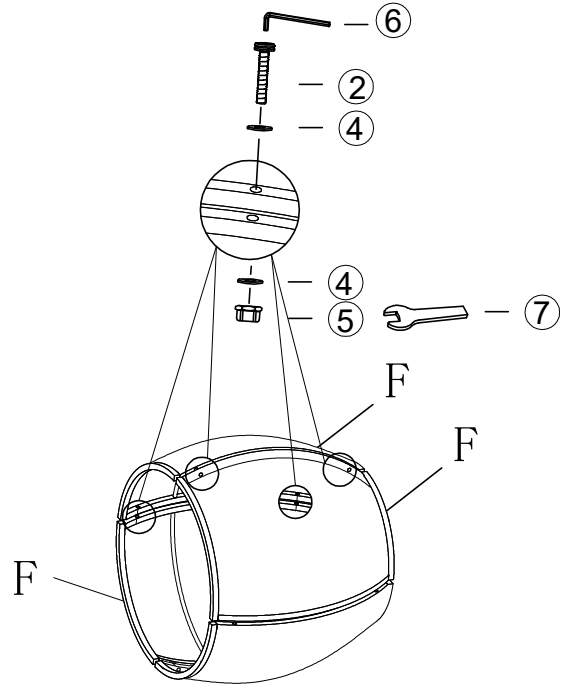
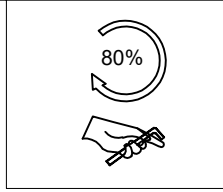
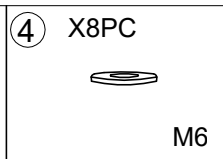
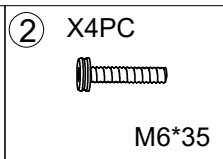
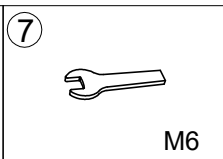
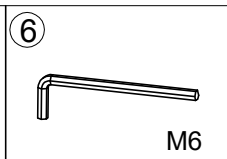

9

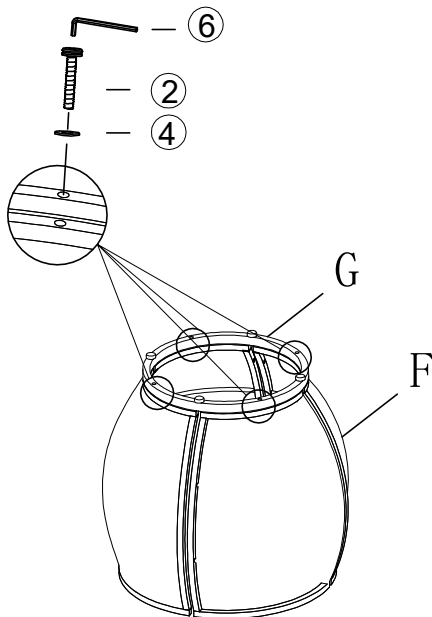
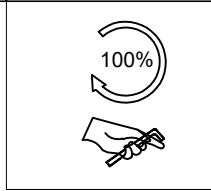
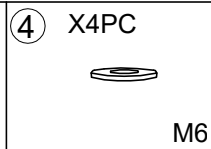
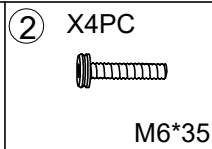
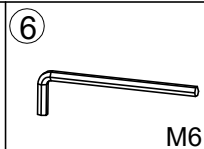

Fully tighten all bolts on this step!

10

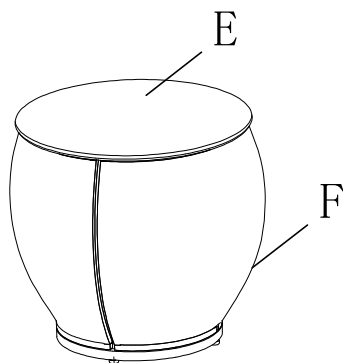

1PCS